

PRODUCT MANUAL

HydroMace[®]

Xci



Includes
FloCom⁺
Configuration Software

Table of Contents

Using the HydroMACE XCi Manual	12
HydroMACE XCi	12
Product Support	14
About MACE	15
WARNINGS	16
Introduction to FloCom+	17
Introducing the HydroMACE XCi device	18
Installing an HydroMACE XCi device	20
Opening procedure	20
Sensor and power cables routed inside the pole	21
Sensor and power cables routed through conduit	24
Sensor and power cables routed through conduit	28
Installing XCi power options	29
Solar panel installation on a 2" pole	30
Installing a MACE mains powered trickle charger	37
Powering the XCi device with an external battery	38
Introduction to FloSeries3 cards	39
Installing FloSeries3 Cards	40
About the I/O Card	44
Connecting sensors to the I/O card	46
Frequency input	46
Digital or Counter input	46
Shaft encoder input	47

Two-wire 4-20mA input	48
Three-wire 4-20mA input	48
Voltage input	48
Digital output	49
4-20mA output	50
About the WebComm card	51
Preparing and installing a Webcomm card	52
Add a WebComm site on the web	54
Configure a WebComm card using FloCom+	57
HTTP Upload	58
FTP Upload to In-Situ HydroVu Data Server	60
FTP Upload	61
Edit HydroVu Headers	62
The "WebComm Utility"	66
Test an HTTP Upload	66
Test an FTP Upload	67
Error messages table:	68
Using "AT+ commands" to troubleshoot a WebComm card	70
Initial upload routine:	71
Common AT+ commands	72
Editing/Viewing a WebComm site on the web	75
Site data	75
Download site data	75
Show latest record	76

Delete site data	76
Site details	77
Site Details	77
Site keys	77
Site alarms	78
Site users	78
Remove site	78
Alarm history	79
All about Webcomm SMS/Email alarms	80
Enable alarm usage	80
Alarm configuration	81
Alarm description:	82
Channel to use for this alarm:	82
Send the alarm when the channel value is above/below:	82
Clear the alarm when the channel value is above/below:	82
Add this value to alarm set point each time the alarm occurs:	82
After the alarm has been sent disable it for:	83
Send an SMS message to these phone numbers:	83
Limit SMS message size:	83
Send an email message to these addresses:	83
Message:	84
Alarm state	85
Edit Alarms	86
Alarm history	87

The FloSI card	88
Wiring a FloSI card	88
Serial interface settings	89
RS-232, ASCII mode	89
SDI-12 mode	89
MODBUS mode	91
Configuring a FloSI card in FloCom+	92
Ordering the SDI-12 or ASCII output string	93
Ordering and setting ModBus registers	94
About the Pulse I/O Card	95
Connecting sensors to the Pulse I/O card	96
The SDI-12 Master Card	98
Introduction to FloCom+	100
Installing FloCom+ Software	101
Connecting to an HydroMACE XCi device	104
Remote communications with an XCi device	107
Enable a “Remote Connection” in the WebComm card	107
Run a WebComm “Forced Upload”	107
FloCom+ - The essential steps to configuring an HydroMACE XCi device	113
Edit general settings	114
Sensor power	115
Add XCi channels	116
Edit XCi Channels	118
Ordering, renaming, setting of attributes and removing channels	119

Reset card/configuration	123
The File menu	124
View download file	125
Table of Status messages	126
View MDCF file	128
Comms settings	129
The Main Menu	130
Disconnect	131
Download	132
Settings	133
Edit settings	133
View settings	133
Save settings to file	134
Load settings from file	134
Measure and display	136
SDI-12 Master utility	137
WebComm utility	137
Start/Stop HydroMACE XCi device	138
The System menu	139
Set device date/time:	139
Change download password	140
Change super password	140
System settings	141
Clear stored data	141

Card check	142
View totals	143
Introduction to XCi channel types	145
Add a "Velocity" - channel type	148
So, what are "Slope" and "Offset"?	150
"Depth" channel from a MACE EchoFlo Depth Sensor	151
Edit a "Depth" - channel type	153
Add a new "4-20mA" input type	154
Edit a "4-20mA" input type	155
Add a new "Binary" channel type	157
Edit a "Binary" channel type	158
Add a new "Frequency" input type	159
Edit a "Frequency" input type	160
Add a new "Voltage" input type	162
Edit a "Voltage" input type	163
Add a new "Event (pulse, status change)" channel type	165
Edit a "Status change event" channel type	166
Edit a "Pulse event" channel type	166
Add a new "Shaft encoder input" input type	168
Edit "Shaft encoder input"	169
Add a new "Input pulse total" channel type	170
Edit an "Input pulse total" channel type	170
Add a new "Flowrate (using pulse)" channel type	172
Edit a "Flowrate (using pulse)" channel type	173

Add a new "SDI-12" input type	175
SDI-12 sensor settings	176
Edit an "SDI-12" input type	177
"Flowrate (using velocity)"- channel type	178
Add a "Flowrate (using velocity)"- channel type	178
Edit a "Flowrate (using velocity)" - In a full pipe or circular pipe using depth	179
Edit a "Flowrate (using velocity)" - In an open channel	179
Using MACE "FloCalc" to calculate polynomial coefficients	180
Add a "Flowrate (using velocity)"- channel type	183
Edit a "Flowrate (using velocity)" - In a full pipe or circular pipe using depth	184
Edit a "Flowrate (using velocity)" - In an open channel	184
Using MACE "FloCalc" to calculate polynomial coefficients	185
Add a "Flowrate (using lookup table)" - channel type	188
Edit a "Flowrate (using lookup table) - channel type	188
Add a "Flowrate (using weir)"- channel type	191
Edit a "Flowrate (using weir) - channel type	192
Add a "Flowrate (using trickle flow)" - channel type	194
Edit a "Flowrate (using trickle flow)" - channel type	195
Add a "Total flow" - channel type	201
Edit a "Total flow" - channel type	202
Add a new "Channel value level or range status" channel type	205
Edit a "Channel value level status" channel type	206
Edit a "Channel value range status" channel type	207
Add a "Velocity (depth corrected)" - channel type	208

Edit a "Velocity (depth corrected)" - channel type	208
Add a "Volume (using lookup table) - channel type	210
Edit a "Volume (using lookup table) - channel type	210
"Device battery voltage" - channel type	213
"Measure and Display" function	215
"Offset adjust" function	216
"2-Point Calibration" function	217
The "SDI-12 Master Utility"	219
"Address query"	220
"Acknowledge active"	221
"Send ID"	221
"User defined"	222
Calibrate - Flowrate (using pulse) function	224
Calculate a "K-factor"	224
Metric Example:	224
US Example:	225
Calibrate function:	226
"4-20mA" - output type	228
Add a new "4-20mA" output	229
Edit a "4-20mA" output	229
Test a "4-20mA" output	230
Remove a "4-20mA" output	231
"4-20mA" - output type	232
Add a new "4-20mA" output	233

Edit a "4-20mA" output	233
Test a "4-20mA" output	234
Remove a "4-20mA" output	235
"Pulse" - output type	236
Add a new "Pulse" output	237
Edit a "Pulse" output	237
Test a "Pulse" output	238
Remove a "Pulse" output	238
"Binary status" - output type	239
Add a new "Binary status" output	240
Test a "Binary status" output	241
Remove a "Binary status" output	242
XCi Display and Keypad Usage	243
"Force" a measurement	244
Reset a "Total" with the buttons	245
Test the LCD Display	246
Troubleshooting the XCi	247
I can't "Connect" to my XCi with FloCom+	248
My XCi has power problems	250
My meter "Total" isn't right	251
My XCi has problems measuring the depth	252
My XCi has problems with the LCD	253
My XCi has problems when I'm connected to FloCom+	254
How to update XCi firmware	255

Prior to upgrading	255
Running the upgrade	256
After the upgrade	257
Battery maintenance	258
Solar panel maintenance	261
How to store the XCi when not in use	262
MACE USB cable driver installation	263
How to re-initialise an XCi	266
MACE product repair procedure	268
MACE Limited Warranty	269

Using the HydroMACE XCi Manual



HydroMACE XCi

Environmental monitor and data logger

The HydroMACE XCi can be used to monitor just about any environmental sensor. Use the versatility of HydroMACE XCi to monitor inputs as diverse as: flumes & weirs, water quality sensors & rainfall gauges, drinking water flows (leak detection) and weather stations

The HydroMACE XCi continues the long heritage established by MACE over 40 years ago for remote data logging and telemetry.

The HydroMACE XCi device typically consists of the following main components:

- The HydroMACE XCi device
- The FloSeries3 card/s providing inputs for connecting an array of sensors
- The sensor(s) or peripheral(s)
- The solar panel (or power supply)
- FloCom+ software enabling you to configure and download data from your HydroMACE XCi device

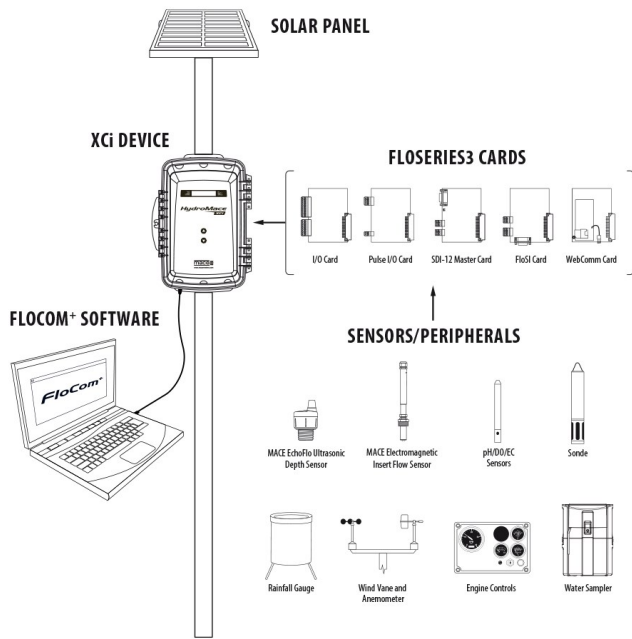

Product Support

Should you experience difficulty in using this product, please contact your local MACE vendor. We also welcome feedback from customers who feel that their experience may provide an improvement to the product or may be beneficial to other users.



NOTE: MACE strongly recommends that users register for Software Updates on the “Support” page of the [MACE Website](#). Releases of product enhancements occur periodically and we recommend that these are uploaded into your XCi device.



NOTE: MACE strongly recommends that users "[subscribe](#)" to the macemeters YouTube channel for video content applicable to installation and maintenance of your XCi system.

Disclaimer

No warranties of any nature are extended by this document. Measuring and Control Equipment Co. Pty. Ltd. (MACE) will not accept any financial or other responsibility that may be the result of your use of this information, including direct, indirect, special or consequential damages.

You must be careful to ensure that the use of this information complies with the laws, rules and regulations of the jurisdictions with respect to which it is used. MACE assumes no responsibility for personal or property damage caused by the misuse of this equipment.

Copyright

Information in this document is subject to change without notice. The software described in this document is furnished under a license agreement or nondisclosure agreement. The software may be used or copied only in accordance with the terms of those agreements. No part of this publication may be reproduced, stored in a retrieval system, or transmitted in any form or any means electronic or mechanical, including photocopying and recording for any purpose other than the purchaser's personal use without the written permission of Measuring & Control Equipment P/L.

Copyright © 1996-2019. MACE P/L. All rights reserved.

Revision number: 19.1

Windows is a registered trademark of Microsoft Corporation in the United States and other countries.

About MACE

MACE is a company founded in 1968 by electrical and mechanical engineer Lawrence Campbell who recognized the importance of flow measurement and flow monitoring in the global environment.

For over 50 years MACE has designed and manufactured electronic monitoring instrumentation including ultrasonic flow meters, data loggers and controllers. Continued commitment to research and development over the past three decades has ensured MACE's provision of the most advanced high technology equipment for the agricultural, industrial and environmental markets.

MACE has a core team of research and development engineers who are focused on providing customer driven products that are both easy to use and withstand the test of time in often remote and harsh environmental conditions.

MACE is committed to providing its clients with personalized service, training and technical back-up to ensure successful monitoring.

MACE continues to innovate with the introduction of the new XCi Multiple Card Interface found in all our new range of flow meters and data loggers. XCi enables the user to connect just about any environmental sensor quickly and easily. This offers the customer a highly flexible, cost effective water monitoring solution.

With the addition of a new MACE WebComm card to any XCi device, customers are able to access their data remotely for free from the MACE website.



An  ***In-Situ*** Company

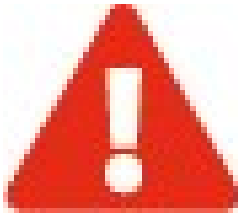

WARNINGS

Water damage

MACE recommends that the HydroMACE XCi device be mounted above known flood peak levels. MACE will not be liable for damage caused by flooding. (The unit is weatherproof, but NOT waterproof and should NOT be submerged).

Sunlight

MACE recommends that the HydroMACE XCi device be mounted so that the LCD faces in a direction away from direct sunlight (ie South in the Southern Hemisphere and North in the Northern Hemisphere).

Cable damage

MACE recommends that all cables be appropriately routed through electrical conduit or other similar mechanism. MACE will not be liable for damage to cables, especially if it is caused by vehicles, digging implements, animals or debris in the pipe or channel.

Insects and moisture

After the HydroMACE XCi device has been installed and fully tested, MACE recommends the use of expanding "space filler" foam down the first 5 to 10cm (2 to 4 ") of the conduit or mounting pole to prevent insect/moisture ingress. Alternatively, where available, a non-curing sealing compound such as "Duct-Seal" may be used.

Battery life

Care must be taken when a mains power supply is used to charge the internal battery instead of a solar panel. If the mains power remains disconnected for an extended period of time, the internal battery may be permanently damaged.

Electromagnetic compatibility (EMC)

This is a Class A product. In a domestic environment this product may cause radio interference in which case the user may be required to take adequate measures.

Intrinsic Safety

The HydroMACE XCi device is NOT an intrinsically safe instrument and should not be installed in hazardous (explosive) environments.

Introduction to FloCom⁺

MACE FloCom⁺ is the software that enables you to communicate, configure and download data from your HydroMACE XCi device

System Requirements

Minimum system requirements for PC are:

- Windows® XP
- 10Mb available hard drive space
- USB port
- For many of the functions described in this manual FloCom⁺ Version 3.X.X.X



MACE Software End User License Agreement (EULA)

Users should read and accept the terms of the MACE EULA before installing FloCom⁺ on their PC. The EULA can be found on the downloads page of the [MACE website](#).

Introducing the HydroMACE XCi device

The HydroMACE XCi device is the central processing unit of the system and includes the enclosure, battery and five card slots allowing the user to install any of the six different FloSeries3 cards that control the sensors.

On the front of the XCi device, a backlit liquid crystal display (LCD) allows the user an on-site readout of parameter values and status messages. Pressing either membrane switch will turn on the LCD.

The membrane switches can be used to scroll the display between the various parameters being measured.

A communications port is located on the bottom face of the main enclosure. Using a MACE USB data cable (Part No. 850-363) between this port and a PC, users can configure, troubleshoot and download data from the device using the MACE FloCom+ software downloadable from www.macemeters.com.

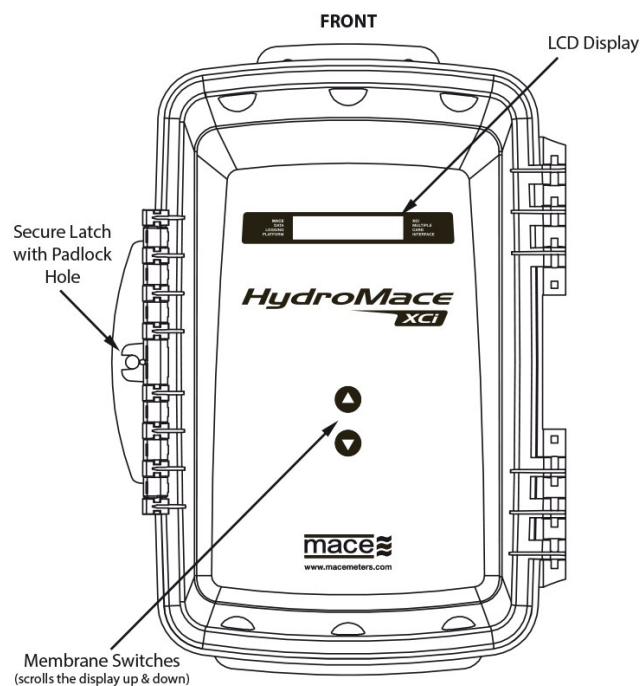

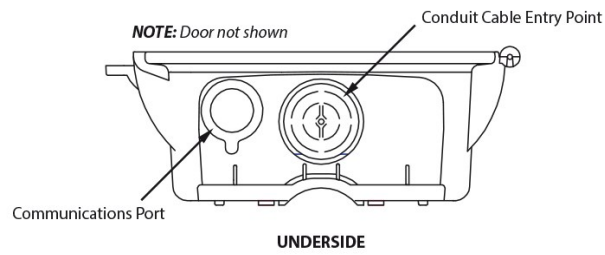
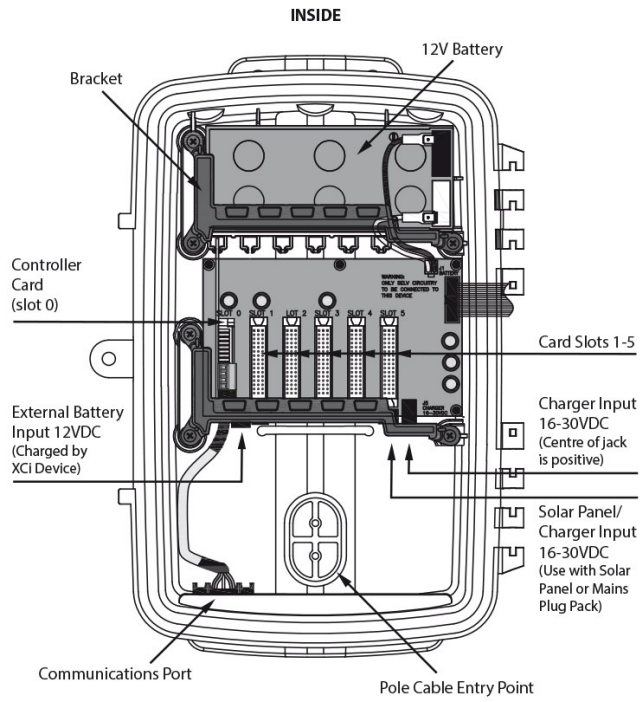

Installing an HydroMACE XCi device

The sensor and power cables can be routed either directly through the inside of the 2" mounting pole or through electrical conduit. Installation directions for both are provided



NOTE: MACE recommends that the XCi device be mounted so that the LCD faces in a direction away from direct sunlight.

Opening the XCi enclosure

Opening procedure

The XCi is housed in a rugged weather-resistant (IP66) enclosure. To ensure that the enclosure is weather-tight, MACE uses a natural rubber seal and a solid latching system. Sometimes (particularly after little use), the latch can be difficult to open. Opening the enclosure is simpler using the following procedure:

1. Ensure that the XCi is either mounted firmly on the pole/wall or is placed squarely on a benchtop.
2. It is best to use both hands to open. Position your hands so that one is above and one is below the "**padlock loop**". This avoids a slight twist if using only a single hand on one end. Grasp the latch and firmly cock your wrists until the latch opens.



NOTE: The latching mechanism can be lubricated using a silicon based aerosol spray such as - CRC® Silicone Lubricant.

Installing on a 2" pole

Sensor and power cables routed inside the pole



NOTE: During installation, some users may find it preferable to remove the battery and internal cards prior to "knocking out" the cable entry point. Refer to [Installing FloSeries3 Cards](#) for details on re-installation.

Place the XCi device on a work bench and using a hammer and screwdriver carefully knock out the plastic cable entry point from the rear of the enclosure. It is only thin plastic and is designed to break away at the edges so work your way around the edge of the oval shape until the cover is completely broken free of the unit.



2. File away any rough edges from the plastic cable entry point

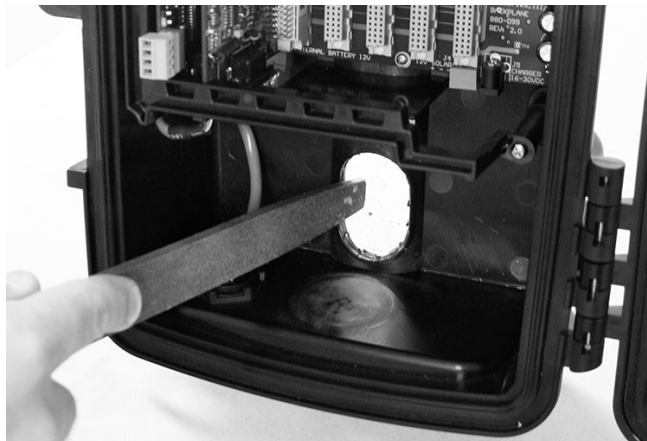



WARNING: Apply NON-ACIDIC cure industrial grade silicon sealant to the back of the XCi device in the channel around the cable entry point. This will stop water flowing down the pole and into the XCi device.



3.

4. Hold the XCi device up against the pole so that the oval cut-away on the pole matches the cable entry point. Route the sensor and power cables through the cable entry point as shown.

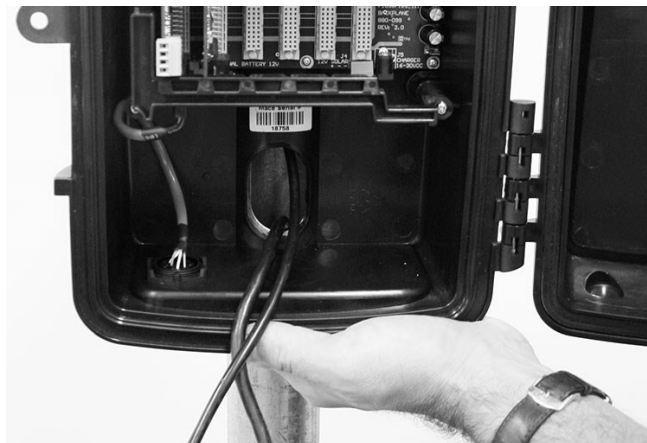

5. Use the two “U” bolts, 3/8” nuts and 3/8” washers provided to secure the XCi device to the pole.



WARNING: Do not overtighten the pole mounting bolts as permanent damage may occur to the electronics enclosure

6. Plug in both the sensor cable and solar panel cable into the sockets as shown in the picture below.

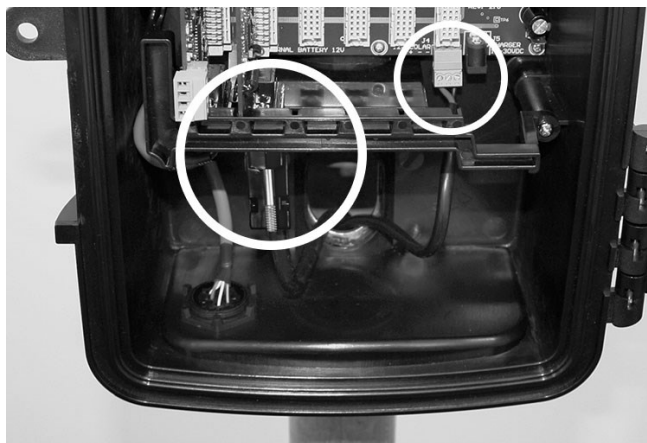

WARNING: Ensure that the cable from the solar panel/charger is terminated using the three-pin connector provided in the electronics box and that the polarity is correct. The polarity is labelled on the circuit board near the connector

7. If using a 16-30VDC mains charger then plug this into the socket shown in the picture below. Alternatively, the charger may be wired into the solar panel screw terminal block (to the left of the socket).

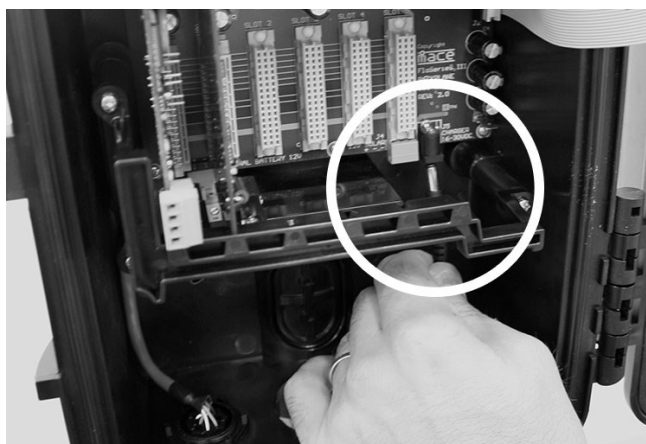

8. Once all the cables are connected the system should be fully tested. Assuming everything is connected and fully functional, in order to prevent insects and/or moisture damaging the system, the cable entry point should be sealed with an appropriate product. Suitable sealants include:

- PanDuit DS1 - Duct Seal Putty (Supplied in MACE mounting kit P/N 850-302)
- Gardner Bender® Duct Seal Putty
- Aftek® Foam Filler
- Great Stuff® Pestblock Insulating Foam



Sensor and power cables routed through conduit



NOTE: During installation, some users may find it preferable to remove the



battery and internal cards prior to "drilling out" the cable entry point. Refer to [Installing FloSeries3 Cards](#) for details on re-installation.

Place the XCi device on a work bench. Using a power drill and 2" holesaw, carefully drill out the round plastic cable entry point at the base of the unit as shown below. It is only thin plastic and is designed to break away. Alternatively, the round cable entry point may be removed using the "hammer and screwdriver" method [described](#).

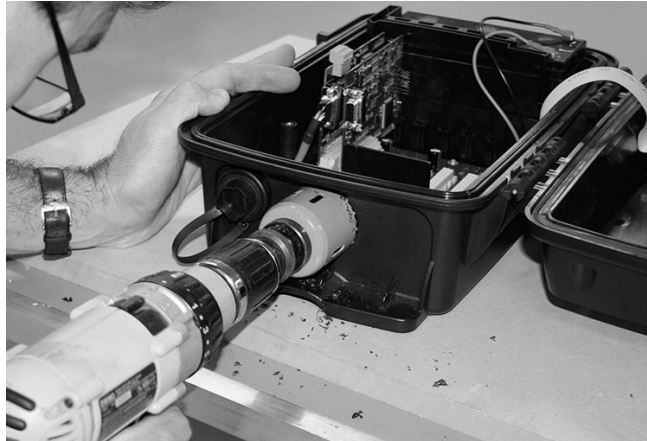

2. Use the two "U" bolts, 3/8" nuts and 3/8" washers provided to secure the XCi device to the pole.



WARNING: Do not overtighten the pole mounting bolts as permanent damage may occur to the electronics enclosure

- Carefully attach an electrical conduit adaptor (Clipsal 50mm or Carlon 1 1/2") to the XCi device.



- Plug in both the sensor cable and solar panel cable into the sockets as shown in the picture below.

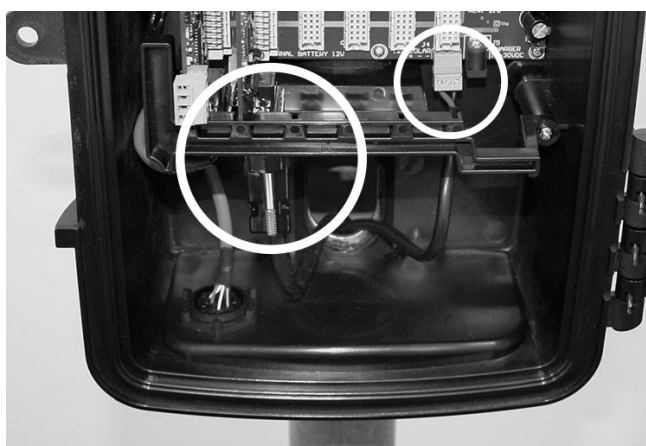

WARNING: Ensure that the cable from the solar panel/charger is terminated using the three-pin connector provided in the electronics box and that the polarity is correct. The polarity is labelled on the circuit board near the connector

5. If using a 16-30VDC mains charger then plug this into the socket shown in the picture below. Alternatively, the charger may be wired into the solar panel screw terminal block (to the left of the socket).

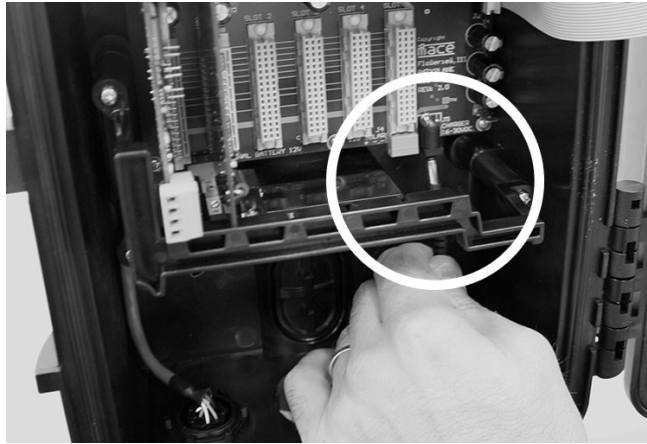

6. Once all the cables are connected the system should be fully tested. Assuming everything is connected and fully functional, in order to prevent insects and/or moisture damaging the system, the conduit entry point should be sealed with an appropriate product. Suitable sealants include:

- Afttek® Foam Filler
- Great Stuff® Pestblock Insulating Foam
- Geocel® Plumbers Putty
- Gardner Bender® Duct Seal Putty



Installing on a wall

Sensor and power cables routed through conduit

1. Follow instructions [here](#) to drill out the cable entry point for routing cables through conduit.
2. Use four M8 screws, bolts or coach screws to secure the box to the wall. *(Use flat washers between the screw head and the box).*



WARNING: Do not overtighten the wall mounting bolts as permanent damage may occur to the electronics enclosure

3. Follow instructions [here](#) to complete routing the cables through conduit.

Installing XCi power options

How much power do I need?

The HydroMACE XCi device utilises a 12 Volt DC lead-acid battery to power the system and connected sensors.

In order to charge the 12VDC battery, the system includes a power regulator, that allows for charging from any DC source with an output of 16-30VDC.



NOTE: For the 12V system to charge, it is recommended that a DC source of at least 16VDC is connected. A source of less than 16VDC will not provide sufficient current to charge the 12V battery. If unsure, please do not hesitate to ask your local MACE representative.



WARNING: The maximum XCi system current available for powering sensors attached to ALL installed cards is 1.25 Amps at 12VDC.



NOTE: It is possible to install both a solar panel and a mains powered trickle charger to the same XCi system. In that case, the charging source that is providing the highest voltage will be used in preference over the other.

Solar panel installation on a 2" pole

The solar panel is used to charge the internal battery of the XCi device where mains power is unavailable. This installation guide assumes you have the MACE mounting kit (850-302).



NOTE: Users are advised to ascertain the suitability of solar panels for their application by checking relevant solar radiation maps for their region (for example those found using a "[Solar Radiation Map](#)"). As a guideline, for an HydroMACE XCi with three I/O cards measuring every five minutes, at least three hours sunlight is required per day.

1. From within the MACE Mounting Kit (850-302) locate the parts associated with the solar panel mounting.
2. Remove the two solar panel side brackets and the M6 x12 bolts, washers (spring/flat) and nuts.

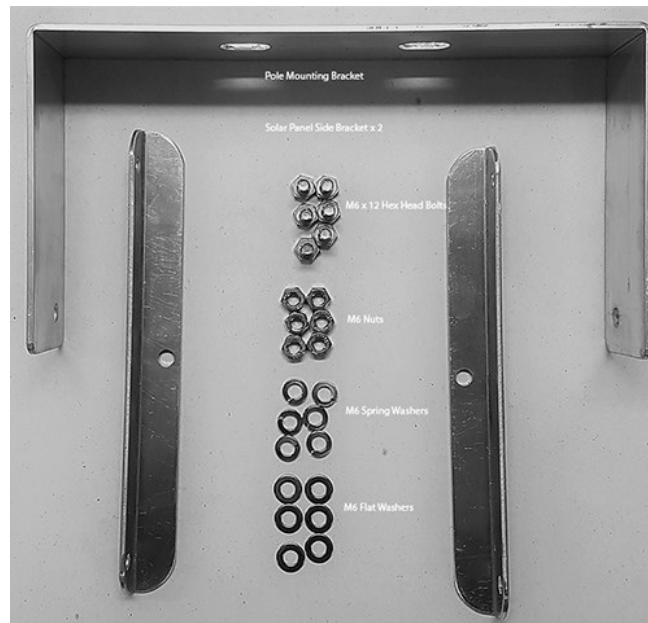

3. Place the side bracket so that the two holes match those in the solar panel frame and the vertical edge is outermost.

4. Use the M6 fasteners to attach each side bracket securely to the solar panel.



5. Place the U-bolt provided in the solar panel mounting kit around the pole.
6. Place the solar panel mounting bracket onto the u-bolt. Ensure that the arms of the bracket face out from the pole and that the mounting hole on each arm is towards the top of each arm.
7. Slide the bracket to the desired position on the pole, taking care to place it at the desired height and so that the open face of the bracket faces towards the sun.

8. Place the 3/8" flat and spring washers on to the U-bolt and tighten the two nuts so that the bracket is secured on the pole.



9. Using the remaining M6 fasteners, attach the solar panel to the U-bolt.
10. Tilt the solar panel so that the active side faces towards the sun ("**North**" in Southern hemisphere, "**South**" in Northern hemisphere) at an angle specified in the data sheet provided. (your latitude + 15°). Now tighten the M6 nuts on each side of the mounting bracket to secure.



11. The cables from the solar panel/charger to the electronics unit must be enclosed to minimise exposure to the elements. The cable should be either routed through conduit or through the solar panel mounting pole. You will need a hole drilled in the mounting pole at the top near the solar panel as well as a cut away where the electronics unit is to be mounted.



12. Ensure that the cable from the solar panel is terminated using the three-pin connector provided in the XCi device and that the polarity is correct. The polarity is labelled on the circuit board near the connector.

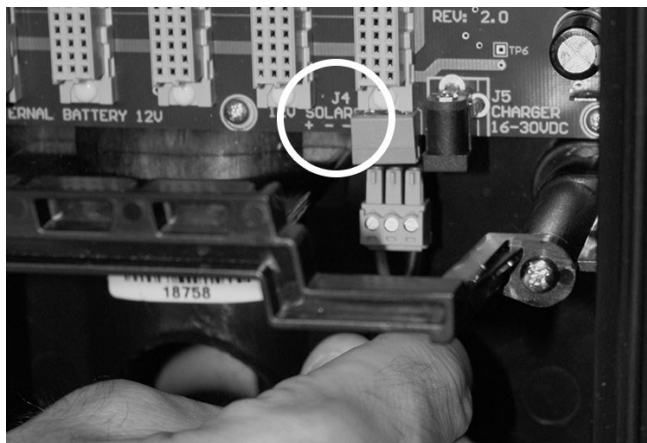
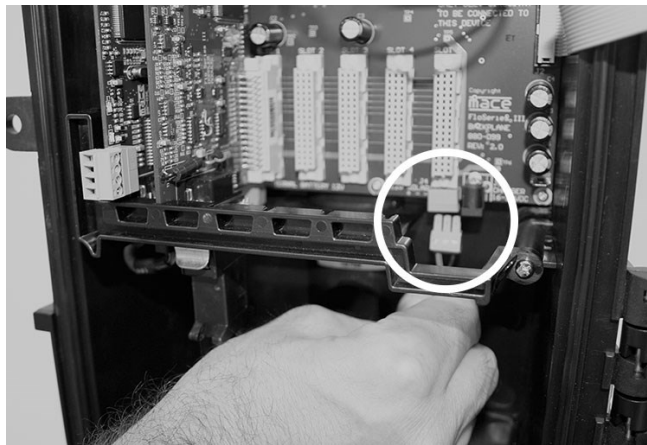

NOTE: The XCi device should be installed before connecting the solar panel.



NOTE: MACE highly recommends the use of Tri-spikes on the top of the solar panel to reduce accumulation of bird droppings on the front face of the solar panel.

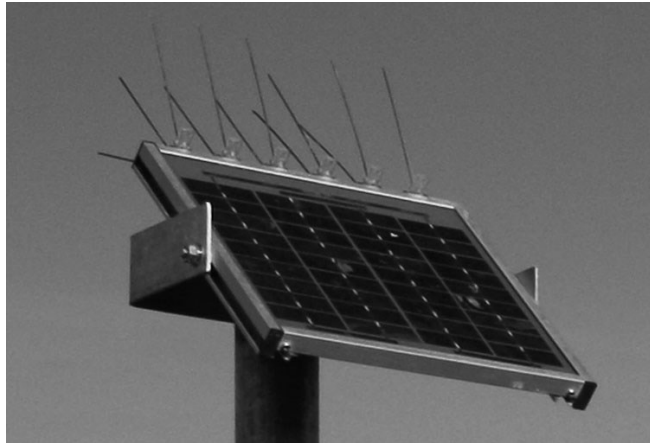

Installing a MACE mains powered trickle charger

In certain applications or where the use of a solar panel is impractical or undesirable, the HydroMACE XCi device can be powered from any DC source of 16-30 Volts (2 Amps).



NOTE: When the ambient temperature is less than -10°C (14F), the battery should be removed to avoid permanent damage to the battery. The XCi device should be powered by an external power source

1. The charger available from MACE (Part No. 850-323) comes complete with a circular barrel connector that plugs directly into the XCi device.



NOTE: The barrel connector for the 16-30VDC charger input is centre positive

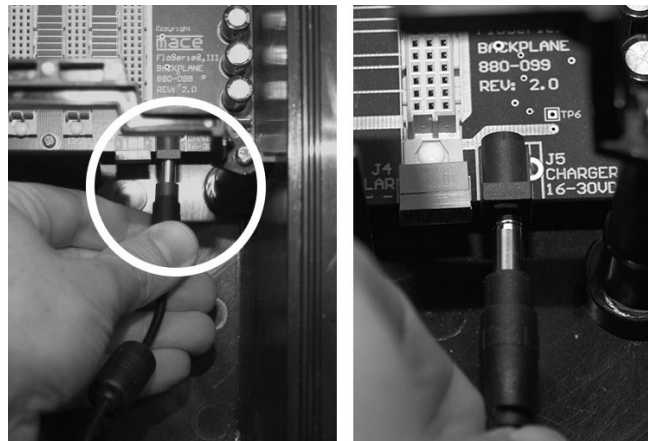

2. Alternatively, if a DC source other than a MACE charger is used, this is terminated using the same three-pin connector as for the [solar panel](#).

Powering the XCi device with an external battery

In certain applications, it may be desirable to power the XCi device with an external battery. For example, if the XCi device is connected to multiple sensors and is configured such that the measuring interval is short.



WARNING: MACE highly recommends that, if an external battery is used, that the main internal XCi battery be left installed. The XCi battery not only provides some "redundancy" in the system, but also provides a power source when the external battery is removed during servicing.

1. The HydroMACE XCi device can be powered by an external 12V battery through the dedicated "External Battery 12V" terminal.

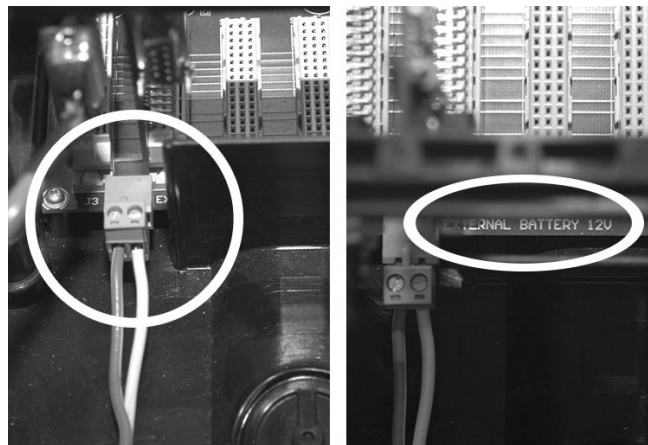

NOTE: If a solar panel is connected to the [device](#), the internal charging circuit of the device will also charge the external battery. The charging circuitry of the XCi device has a 20 Watt capacity.



WARNING: If the external battery is charged via its own solar panel and NOT through the XCi charging circuit, the internal device battery will discharge completely

Introduction to FloSeries3 cards

Multiple cards for multiple sensor applications.

The XCi system (multiple card interface) allows the user to monitor just about any sensor. Users can install any combination of the six MACE FloSeries3 cards shown, into the five available card slots within an XCi device. Choose the right card/s for your application to tailor the XCi device to your exact monitoring requirements.

With a MACE WebComm card installed, your data can be accessed free, 24/7 from the MACE website via PC or smartphone.

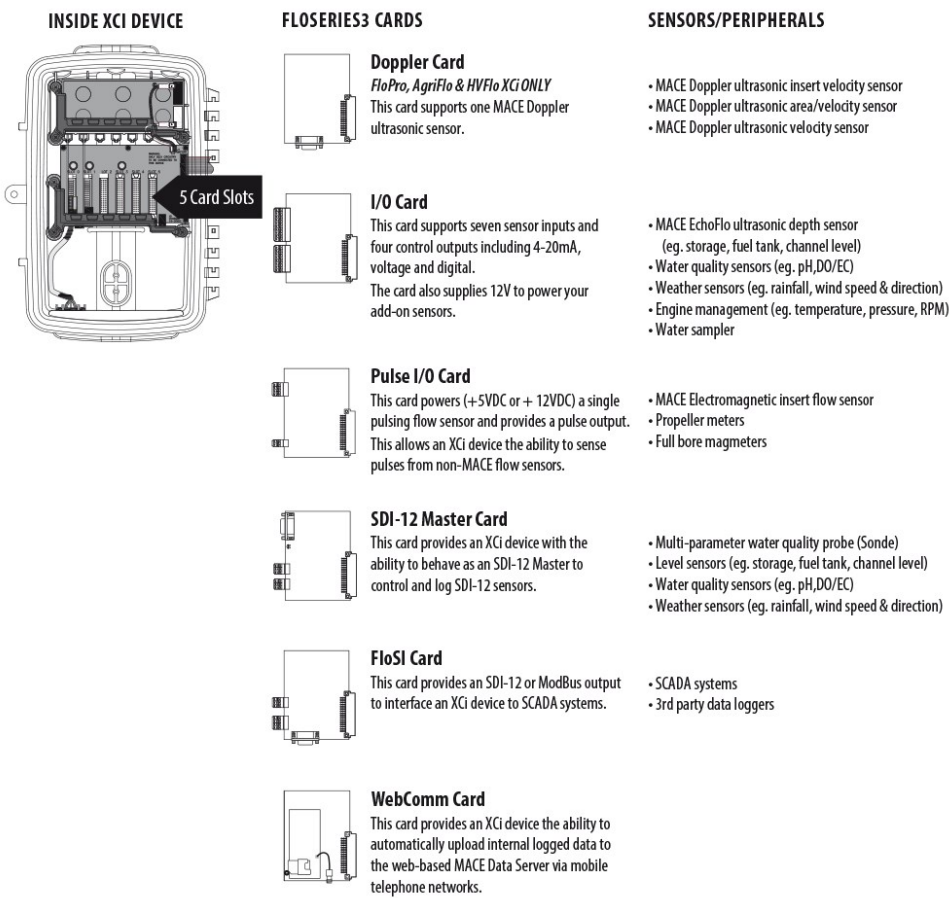

Installing FloSeries3 Cards



WARNING: Where this procedure is carried out on a system that has already been installed and a card/s is being replaced or added you **MUST:**

- Connect with FloCom+
- Stop the device
- Save the device settings
- Download the logged data
- Disconnect from the device

1. Open the XCi enclosure and ground yourself by touching the screw labelled “**Ground yourself here**” on the LCD circuit board.



2. Remove the three screws (using a #2 Phillips screwdriver) fastening the PCB clamping bracket.

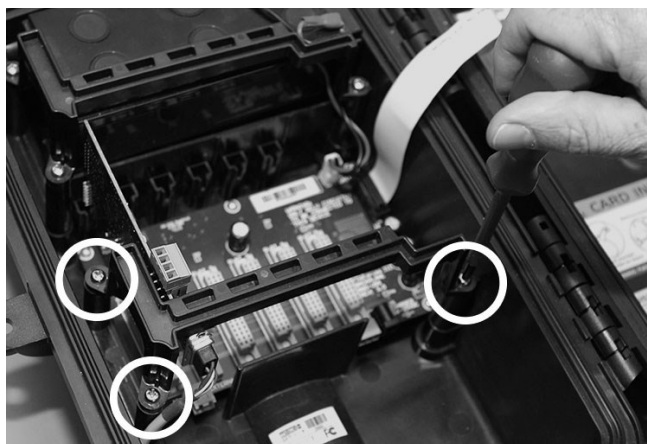



WARNING: Take care not to drop screws in the box as damage may occur to the circuitry

3. Ground yourself again as per instructions in Step 1.
4. Remove the FloSeries3 card from its packaging. Position the new card in your hand such that the large cream 48-pin connector is facing down and aligned with the mating connector on the backplane PCB.

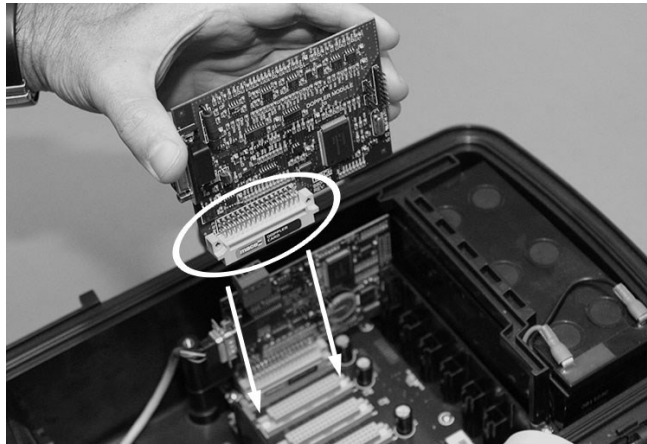

5. **Ground yourself again.** Your finger must remain grounded on the screw whilst carefully inserting the card into any spare slot. Take care to align the pins of the two connectors together. There is a slot at the top of the card area that helps the alignment process. Ensure that the card is contained within this slot and press down firmly to ensure that it is fully seated.



NOTE: If installing a WebComm card then you **MUST** use card slot 5.



6. Replace the PCB clamping bracket ensuring that the slots in the underside of the bracket are aligned with the tops of all the cards. Fix the bracket into place with the three screws.

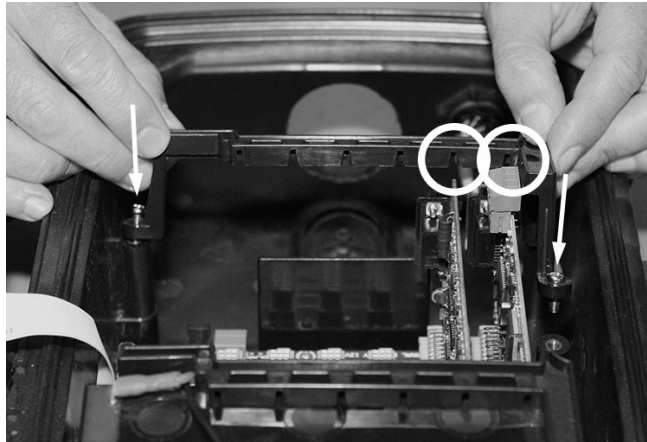

WARNING: DO NOT over tighten the screws as the bracket may be damaged or broken

7. “**Connect**” to the HydroMACE XCi device with a PC using FloCom⁺ ([Connecting to an HydroMACE XCi device](#))



- From the main menu of FloCom+ click “**System**” then “**Card check**” and ensure that your newly installed card/s are listed **and in the correct card slots**.

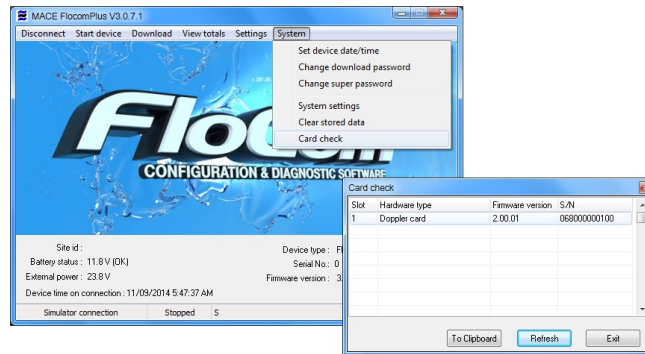

- If they are not listed and/or not in the correct slot, “**Disconnect**” from the device in FloCom+.
- REMOVE** the offending card/s and **WAIT for at least one minute. This allows the microprocessor on the card to reset.** Follow steps 1-9 for re-installation.



WARNING: Before removing the card/s you MUST re-ground yourself by following the procedure outlined in step 1.

About the I/O Card

The installed I/O card (see [Installing FloSeries3 Cards](#)) provides the inputs for connecting environmental monitoring sensors and outputs for connection to ancillary devices. Once a sensor has been wired to the I/O card it must be configured using FloCom+ software so that the XCi device can control and record data from the sensor.



NOTE: See [Connecting sensors to the I/O card](#)

The input and output terminals available on each I/O card are shown in the diagram below.



NOTE: MACE recommends the user studies the relevant documentation supplied with each third party sensor prior to connection.



WARNING: The maximum XCi system current available for powering sensors attached to ALL installed cards is 1.25 Amps at 12VDC.



WARNING: The maximum input voltage on any terminal is 30VDC.

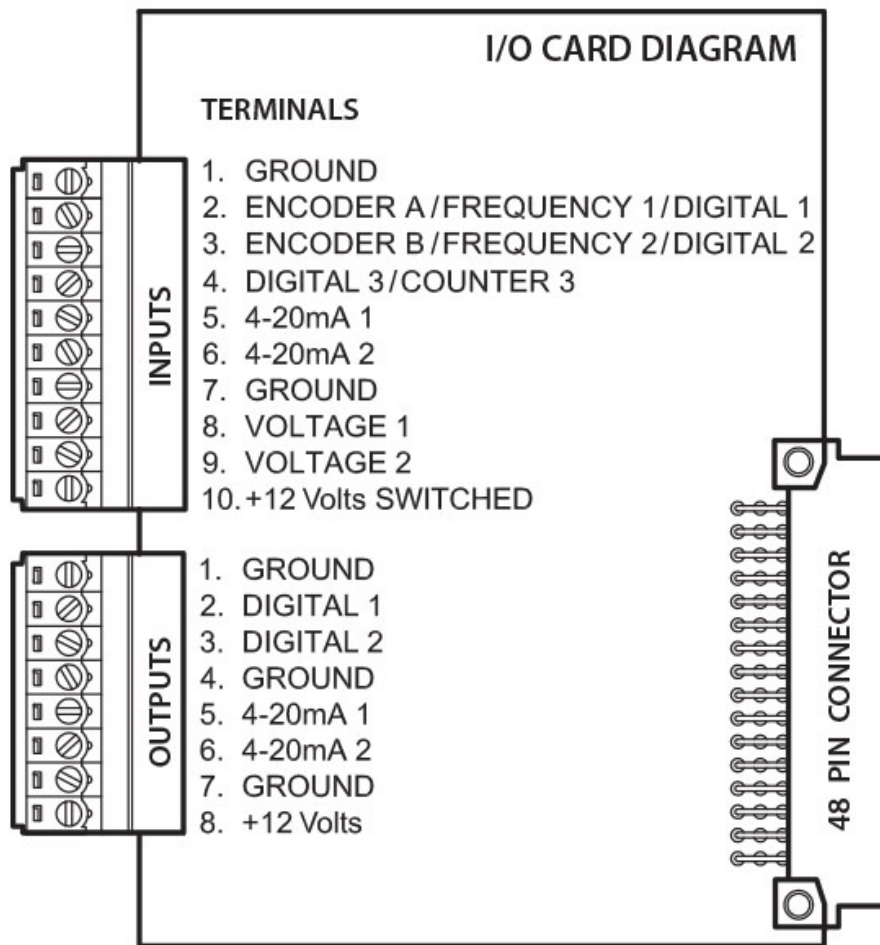

NOTE: Should insufficient I/O be available on a single I/O card another card (Part No. 850-329) should be purchased.

Connecting sensors to the I/O card



NOTE: A nominal 12 VDC (non-regulated battery voltage) sensor power is available on terminal 10 of the input terminal strip. This is a switched power supply and the warm up time for sensors that require power is configurable using FloCom+ software. See [Sensor power](#).

Wiring digital inputs

Frequency input

Each I/O card provides up to two frequency inputs for connecting devices such as ultrasonic depth sensors and/or flow meters. The frequency input terminals available on each I/O card are shown in the diagram below.



NOTE: If a frequency input is wired a shaft encoder input is not available

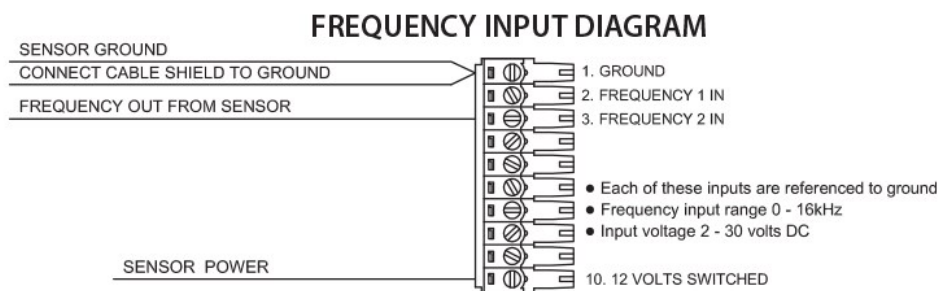

After completing the wiring, configure the sensor using FloCom+ (see [Add a new "Frequency" input type](#))

Digital or Counter input

Each I/O card provides up to three digital inputs or one counter input for connecting devices such as rainfall gauges, hours run meters and/or counting pulses. The digital/counter input terminals available on each I/O card are shown in the diagram below.



NOTE: If a shaft encoder input is wired only a single digital/counter input is available

DIGITAL OR COUNTER INPUT DIAGRAM

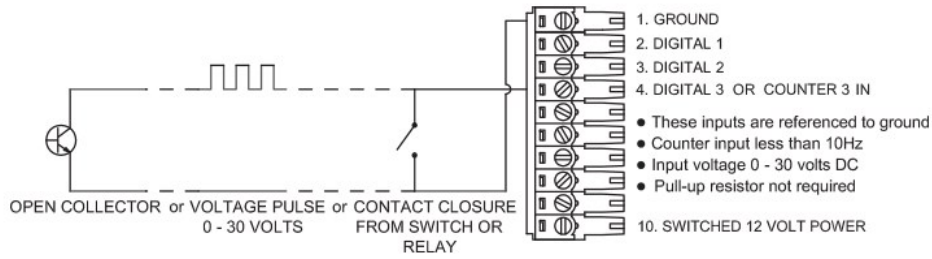

After completing the wiring, configure the sensor using FloCom+ (see [Add a new "Binary" channel type](#) or [Add a new "Input pulse total" channel type](#))

Shaft encoder input

Each I/O card provides one input for connecting a shaft encoder. The shaft encoder input terminals available on each I/O card are shown in the diagram.



NOTE: If a shaft encoder input is wired only a single digital/counter input is available. NO frequency input is available

SHAFT ENCODER INPUT DIAGRAM

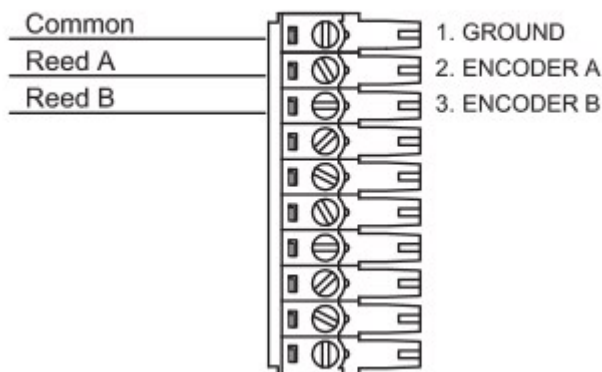

After completing the wiring, configure the sensor using FloCom+ (see [Add a new "Shaft encoder input" input type](#))



NOTE: Should the field application require a shaft encoder and a frequency input another I/O card (Part No. 850-329) should be purchased

Wiring analogue inputs

Two-wire 4-20mA input

Each I/O card provides up to two 4-20mA inputs for connecting devices such as ultrasonic depth sensors and/or flow meters. The 4-20mA input terminals available on each I/O card are shown in the diagram below.

2 - WIRE 4-20mA INPUT DIAGRAM

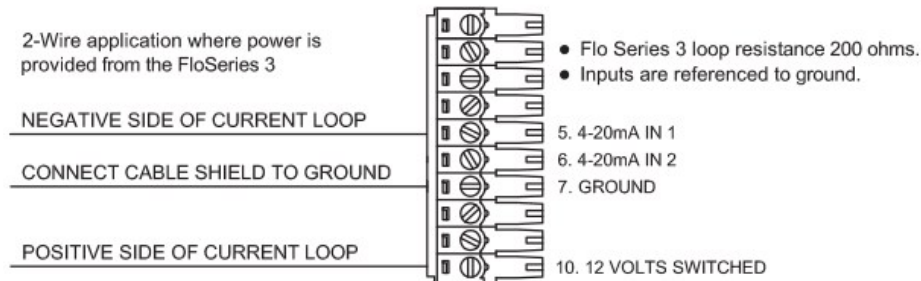

NOTE: When powering 4-20 mA sensors, users should be aware that the voltage drop may mean that less than 12 VDC is available. This may result in erratic sensor behaviour.

After completing the wiring, configure the sensor using FloCom+ (see [Add a new "4-20mA" input type](#))

Three-wire 4-20mA input

Each I/O card provides up to two 4-20mA inputs for connecting devices such as ultrasonic depth sensors and/or flow meters. The 4-20mA input terminals available on each I/O card are shown in the diagram below.

3 - WIRE 4-20mA INPUT DIAGRAM

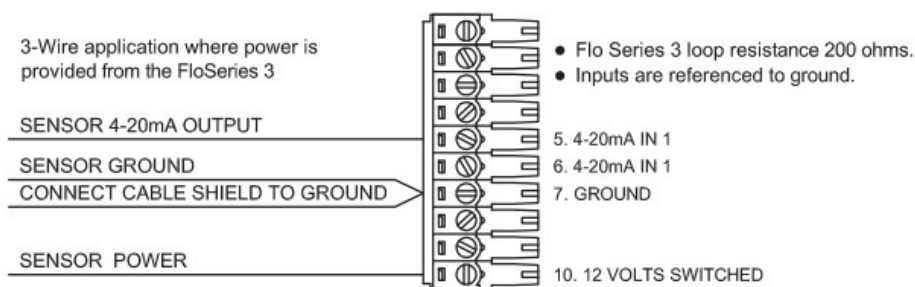

After completing the wiring, configure the sensor using FloCom+ (see [Add a new "4-20mA" input type](#))

Voltage input

Each I/O card provides up to two voltage inputs for connecting devices such as ultrasonic depth sensors, conductivity probes and/or temperature sensors. The voltage input terminals available on each I/O card are

shown in the diagram below.

VOLTAGE INPUT DIAGRAM

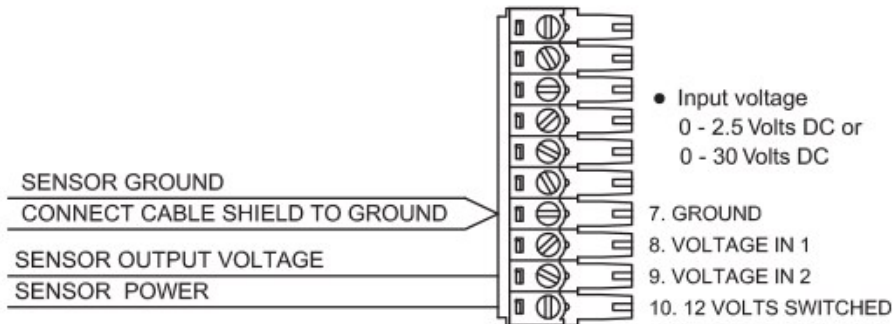

NOTE: The input voltage range can be either 0 - 2.5 VDC or 0 - 30 VDC.

After completing the wiring, configure the sensor using FloCom+ (see [Add a new "Voltage" input type](#))

Wiring digital outputs

Digital output

Each I/O card provides up to two digital outputs for sending pulses to devices such as water samplers and/or data loggers. The digital output terminals available on each I/O card are shown in the diagram below.



NOTE: The pulse output consists of a 50 millisecond pulse with a 50 millisecond space between pulses.

DIGITAL OUTPUT DIAGRAM

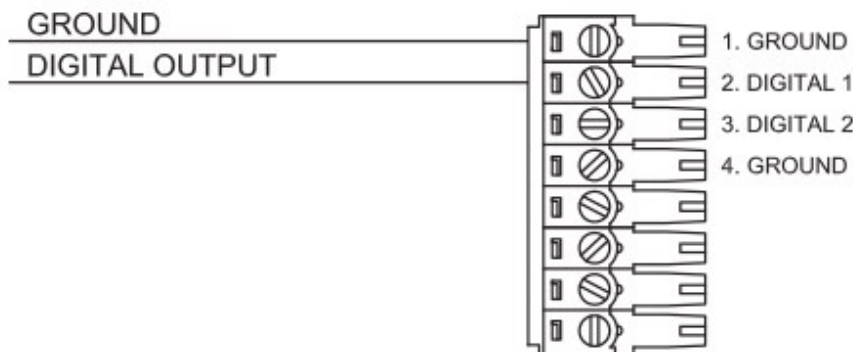

After completing the wiring, configure the output using FloCom+ (see ["Pulse" - output type](#))

Wiring analogue outputs

4-20mA output

Each I/O card provides up to two 4-20mA outputs for sending signals to devices such as SCADA systems and/or PLC's. The 4-20mA output terminals available on each I/O card are shown in the diagram below.

4-20mA OUTPUT DIAGRAM

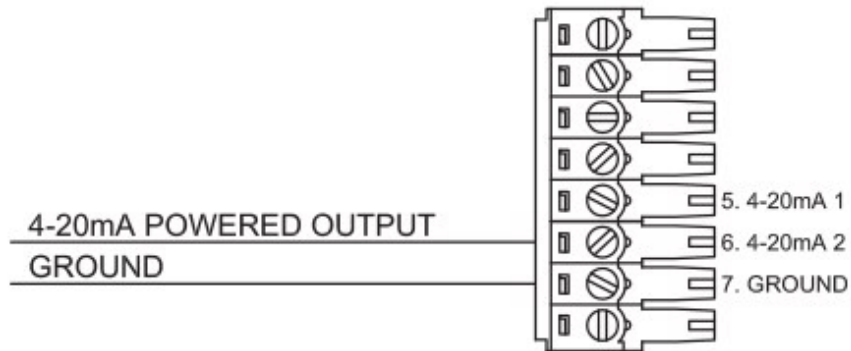

After completing the wiring, configure the output using FloCom+ (see "4-20mA" - output type)

About the WebComm card

The MACE WebComm card provides all MACE XCi devices the ability to automatically upload internal logged data (via HTTP) to the web-based MACE Data Server via mobile telephone networks. The MACE Data Server is integrated with the www.macemeters.com and www.maceusa.com websites, and allows easy access for retrieval of field data. Unlike “conventional” data services, MACE provides this data server free of charge to its customers (subject to MACE SLA).

Alternatively, the WebComm card may be configured to upload via FTP directly to HydroVu Data Services or other FTP servers.



NOTE: Only a WebComm Gen2 card can perform FTP uploads.

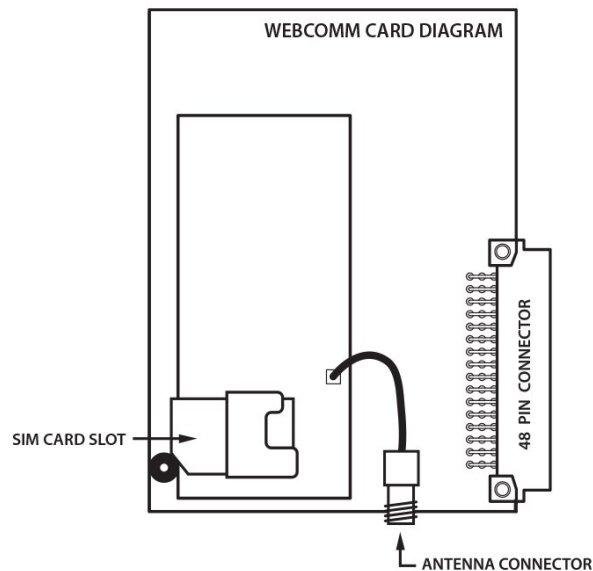

NOTE: Only one WebComm card per XCi device is supported. The WebComm card should be installed in card slot #5 of the XCi device



WARNING: The following "*Essential Steps*" are required to successfully setup a WebComm card and view data on the MACE data server.

Preparing and installing a Webcomm card



NOTE: Contact your cell provider for a SIM card/data plan.



NOTE: MACE recommends that all cables be appropriately routed through electrical conduit or other similar mechanism. MACE will not be liable for damage to cables, especially that caused by vehicles, digging implements, animals or debris in the pipe or channel.

1. Ensure the antenna cable is appropriately routed through conduit and entering the XCi enclosure.
2. Position the SIM card with the cutout notched corner on the right with the electronic chip facing down as shown.

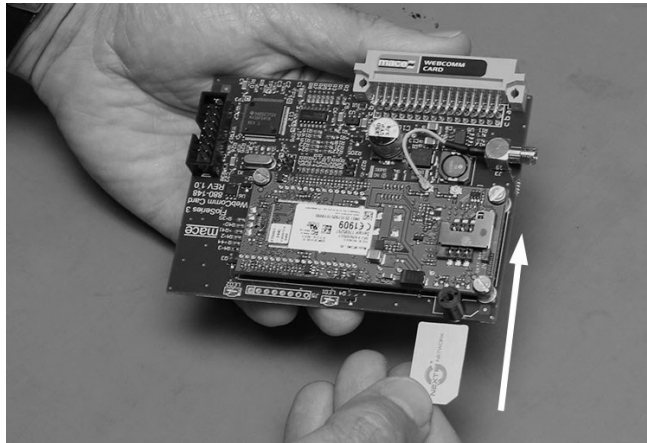

3. Slide the SIM card into the slot until it is fully seated and behind the small black "**holding pin**".

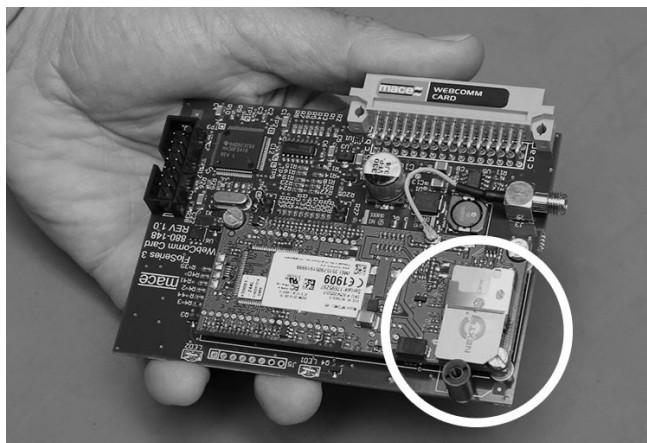

4. Screw the supplied antenna onto the SMA antenna connector.



WARNING: DO NOT USE tools to tighten antenna. Finger tighten only.

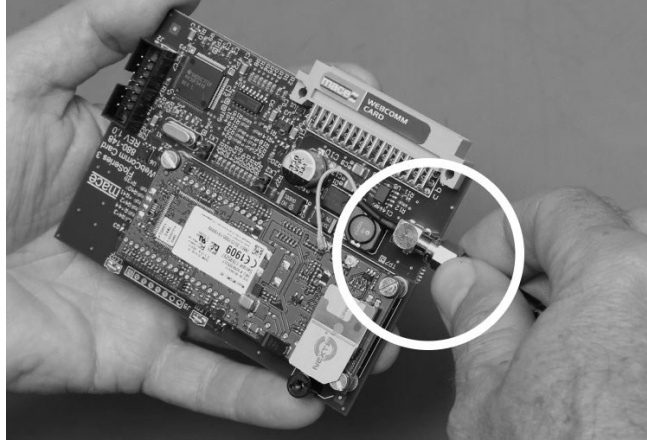

5. The WebComm card is now ready to be installed into the XCi device.
6. Follow [Installing FloSeries3 Cards](#) to install the WebComm card into the XCi device.



NOTE: The WebComm card should be installed in card slot #5 of the XCi device as shown

Add a WebComm site on the web



NOTE: If you haven't already done so, you need to register for a "**User Login**" on the www.macemeters.com website.

1. "**Login**" to www.macemeters.com with your "**User Login**" and "**Password**". Navigate to the "**WebComm**" page.
2. Click on the "**Add new site**" tab.

All times shown on this page are site local time.
Your current alarm credit is 0 alarms.

My sites | **Add new site** | **Purchase alarm credits**

Site ID: * (maximum 8 characters) Fields marked with * are required.

Site Timezone: *

Site Description:

Site Access: Allow MACE support staff to access this site
 Allow third-party applications to download site data directly from the MACE Data Server.

[Back to top](#)

3. Select a "**Site ID**". This should be the same "**Site ID**" that the XCi device in the field will have. Select the appropriate "**Site Timezone**" from the drop-down list and provide a "**Site Description**" if desired.



NOTE: The "Site ID" entered in this field will be overwritten by the "Site ID" of the XCi device in the field if it is different.



NOTE: MACE recommends that the user does not use daylight savings time. Users should set to standard time zone at all times.

4. Check the appropriate boxes for "**Site Access**"
 - Allow MACE support staff to access this site to enable quick and easy help and problem diagnostics
 - Allowing third-party applications to download site data directly, enables other manufacturers software to directly interrogate the MACE Data Server which alleviates the need for access through the MACE website.
5. Click "**Save site details**" and the "**My sites**" tab-sheet will appear.

All times shown on this page are site local time.
Your current alarm credit is 0 alarms.

Site ID	Site Description	Latest Record
WCTest	WebComm Test Site for XCI Manual	

[Back to top](#)

6. Click on the "**Site ID**" hyperlink of the site you've just added, and you will be directed to the "**Site Information**" page.

Site information

[Site details](#) [Site data](#) [My sites](#)

All times shown on this page are site local time.

Site data

[Download site data](#) [Show latest record](#) [Delete site data](#)

Site ID: **WCTest**
Site description: **WebComm Test Site for XCI Manual**
Last record downloaded: **You have not downloaded any of the data available.**
Suppress status messages:
Enter start date: Enter end date:
YYYY-MM-DD or YYYY-MM-DD HH-MM-SS Leave blank for all data
YYYY-MM-DD or YYYY-MM-DD HH-MM-SS Leave blank for all data
[View site data](#) [Download site data](#)

[Back to top](#)

Site details

[Site details](#) [Site keys](#) [Site alarms](#) [Site users](#) [Remove site](#) [Alarm history](#)

Last update: 2014-11-05 12:32:24 [Edit site details](#)

Site ID: **WCTest**
Site Timezone: **(UTC+10:00) Australia Eastern Time**
Site Description: **WebComm Test Site for XCI Manual**
Site Access: **MACCE support staff have access to this site.**
Data from this site can be downloaded directly from the MACCE data server.
Oldest data record: **There is no data stored for this site.**
Last record uploaded: **There is no data stored for this site.**
Server storage used: **There is no data stored for this site.**
Device type:
Serial number:
Firmware:
Signal strength: **0**

[Back to top](#)

7. From within the "**Site details**" area of the page, click on "**Site keys**" tab.

Site details

[Site details](#) [Site keys](#) [Site alarms](#) [Site users](#) [Remove site](#) [Alarm history](#)

Device upload configuration

These parameters must be entered into the device configuration before data can be uploaded.

Username: [Edit username in your profile](#)
Site upload key: **BLUW-UFPPY-E4MC** [Change upload key](#)
[Save upload details to a text file](#)

Device download configuration

These parameters must be used when downloading site data directly from the MACCE data server.
You do not need to use these parameters if you are downloading your data via this website.

Username: [Edit username in your profile](#)
Site download key: **There is no download key set for this site** [Set download key](#)

[Back to top](#)

8. If this is the first time you have added a WebComm site you must create a new "**Username**". Click on the "**profile**" hyperlink and you will be re-directed to the "**WebComm settings**" tab sheet of the "**My Details**" page of the website.

- Click on "**Change**" and a field will appear where you may create a "**Username**". Click "**Save username**" and navigate back to the WebComm "**Site information**" page, and then the "**Site keys**" tab sheet.

The screenshot shows the WebComm settings interface. The top navigation bar includes tabs for 'My details', 'Mailing lists', 'Webcomm settings', and 'Change password'. The 'Change password' tab is active, displaying a table of settings:

Username:	Change
SMS phone number:	Change
SMS alarms: Receiving SMS alarms is disabled.	Enable
Email alarms: Receiving email alarms is disabled.	Enable
Alarm credits: 0	Purchase

Below the table, there are three bullet points:

- The settings here are used for all WebComm sites you own, have access to or are configured to send alarms to you.
- The phone number above is used for all SMS alarms that are configured to send messages to you.
- If you disable alarms here you **will not receive** messages from any WebComm sites.

The second screenshot shows the 'Create username' form. It has a red error message: "A username is required before you can add a new site." Below this is a section titled "Enter your new username" with a text input field containing "UserName" and a "x" icon. A required message states: "Required: Your username must be at least 4 characters long." At the bottom of the form are "Save username" and "Cancel" buttons.

The third screenshot shows the 'Site details' page with tabs for 'Site details', 'Site keys', 'Site alarms', 'Site users', 'Remove site', and 'Alarm history'. The 'Device upload configuration' section is active, showing:

- Username: **UserName** (with a link to "Edit username in your profile")
- Site upload key: **BLUW-UPFY-E4MC** (with links to "Change upload key" and "Save upload details to a text file")



NOTE: This Username must be at least 4 characters long and only contain letters and numbers.

- The details that you will require to configure your MACE WebComm card in the field are located in the "**Device upload configuration**" field. Click on the "**Save upload details to a text file**" hyperlink and the details will be saved to a text file called "**Site upload configuration (Site ID).txt**". This text file will be needed when you are configuring the WebComm card in the field.



NOTE: The WebComm card is now ready to be configured using FloCom+ software. See [Configure a WebComm card using FloCom+](#)

Configure a WebComm card using FloCom+

This procedure should be undertaken after the WebComm and SIM has been installed *per* [Preparing and installing a Webcomm card](#)



NOTE: You will need the "**Bearer information**" supplied by your cell provider for the SIM card/data plan.

1. From the "**Device settings**" dialogue box, click "**WebComm**" and the "**WebComm card configuration**" will appear.

Webcomm card configuration

Upload interval: disabled Show passwords

Bearer APN:

Bearer user name:

Bearer password:

SIM card PIN:

MACE Server

URL: http:// data.macemeters.com

User name:

Upload key: Enable Remote Connection

HTTP upload

Enabled Use MACE server

URL: http://

User name:

Password: Correct clock using host time

FTP upload

Enabled Use Hydrovu Server

URL: ftp://

Directory:

User name:

Password:

Apply Exit

2. Enter the appropriate "**Bearer information**" as supplied by your cell network provider
 - "**Bearer APN**" - Bearer Access Point Name
 - "**Bearer user name**" - if required
 - "**Bearer password**" - if required



NOTE: SIM cards provided by MACE and In-Situ both require the APN to be set to - EM



NOTE: "SIM card PIN" - MACE recommends disabling any PIN

3. Enable either "**HTTP Upload**" or "**FTP Upload**" by checking the appropriate box.



NOTE: The MACE WebComm card can perform both an HTTP and FTP upload simultaneously. This means for example, that data can be sent to the In-Situ HydroVu FTP server or a water authority FTP server as well as the MACE HTTP Data Server.

HTTP Upload



NOTE: Unless using a different data server, leave the HTTP Upload "Enabled" and "Use MACE Server" check boxes ticked.

1. The "**Server URL**" should remain as "**data.macemeters.com**" unless you are uploading to a different HTTP server.
2. From the information contained in the file called "**Site upload configuration (Site ID).txt**" that was saved during the procedure outlined in [Add a WebComm site on the web](#), copy/paste the relevant "**Server user name**" and "**Upload key**".

```
File Edit Format View Help

Webcomm card site upload configuration

SiteID:           WCTest
Site description: WebComm Test Site for XCi Manual

Username:         UserName
Site upload key:  BLUW-UFPY-E4MC
```



NOTE: Check on "**Show passwords**" to enable easy viewing of the "**Upload key**"

3. Leaving the "Enable Remote Connection" check box ticked will allow for [Remote communications with an XCi device](#)
4. Checking the "**Correct clock using host time**" check box, will ensure that your XCi device time will always be correct. The WebComm card will "talk" to the MACE data server and correct the device time as necessary. This ensures you always have the correct time in your dataset.

The screenshot shows a 'Webcomm card configuration' dialog box with the following fields and options:

- Upload interval:** 1 hour (dropdown menu)
- Show passwords:**
- Bearer APN:** Cell Provider APN
- Bearer user name:** [text input]
- Bearer password:** [text input]
- SIM card PIN:** [text input]
- MACE Server:**
 - URL:** http:// data.macemeters.com
 - User name:** UserName
 - Upload key:** BLUW-JFPY-E4MC
 - Enable Remote Connection:**
- HTTP upload:**
 - Enabled:**
 - Use MACE server:**
 - URL:** http:// [text input]
 - User name:** [text input]
 - Password:** [text input]
 - Correct clock using host time:**
- FTP upload:**
 - Enabled:**
 - Use Hydrovu Server:**
 - URL:** ftp:// [text input]
 - Directory:** [text input]
 - User name:** [text input]
 - Password:** [text input]

Buttons: Apply, Exit

FTP Upload to In-Situ HydroVu Data Server



NOTE: If you are using the HydroVu Data Server, contact your local MACE or In-Situ representative for the authentication details required.

1. Leave the "**Use HydroVu Server**" box checked.
2. Enter the authentication details as supplied by MACE or In-Situ.

Webcomm card configuration

Upload interval: 1 hour Show passwords

Bearer APN: Cell Provider APN

Bearer user name:

Bearer password:

SIM card PIN:

MACE Server

URL: http:// data.macemeters.com

User name: UserName

Upload key: BLUW-UFPY-E4MC Enable Remote Connection

HTTP upload

Enabled Use MACE server

URL: http://

User name:

Password: Correct clock using host time

FTP upload

Enabled Use Hydrovu Server

URL: ftp:// ftp.hydrovu.com:2121

Directory: ./

User name: UserName

Password: 12345678

Apply Exit

3. The "**HydroVu headers**" must now be [Edit HydroVu Headers](#)

FTP Upload



NOTE: If you are using FTP uploads to an FTP data server, contact your Network Administrator for the server details required.

1. Enter the "**Server URL**"
2. Enter the file "**Directory**"
3. Enter the authentication details as required.

Webcomm card configuration

Upload interval: 1 hour Show passwords

Bearer APN: Cell Provider APN

Bearer user name:

Bearer password:

SIM card PIN:

MACE Server

URL: http:// data.macemeters.com

User name: UserName

Upload key: BLUW-JFPY-E4MC Enable Remote Connection

HTTP upload

Enabled Use MACE server

URL: http://

User name:

Password: Correct clock using host time

FTP upload

Enabled Use Hydrovu Server

URL: ftp:// ftpserver.test.com

Directory: /uploads

User name: UserName

Password: 12345678

Apply Exit

3. Select the appropriate "**Upload interval**" for your application from the drop-down list.
4. Click "**Apply**", then "**Exit**" to return to the "**Device settings**" dialogue box.
5. You should now run [The "WebComm Utility"](#)

Edit HydroVu Headers

Get real-time, decision-quality data on your remote monitoring sites anywhere, anytime, with In-Situ HydroVu Data Services. HydroVu gives you up-to-date access to your data while simplifying the task of filtering the data for important results.



NOTE: Visit [HydroVu Data Services](#) for further details.

After enabling [FTP Upload to In-Situ HydroVu Data Server](#), the following procedure must be carried out to ensure that data is visible on the HydroVu platform:

1. The "**HydroVu headers**" dialogue box will now be enabled on the "**Device settings dialog**"

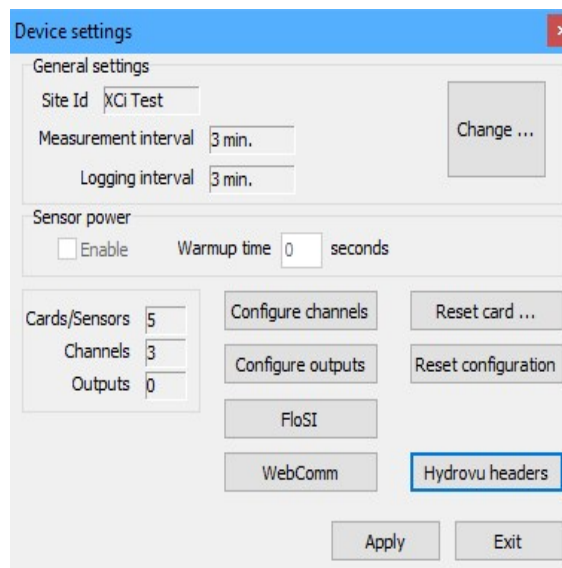

- Click on "**HydroVu headers**" menu item and the "**HydroVu header information**" box will appear.

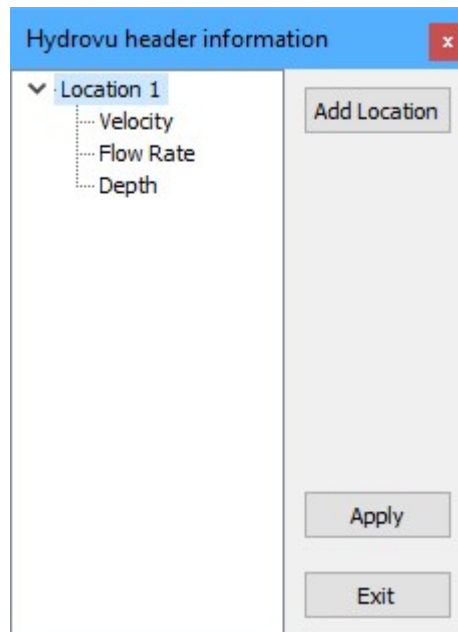

The following "**XCi Channel types**" are supported implicitly within HydroVu. That is, the full range of data viewing and analysis features are available. For "**Channel types**" not supported, HydroVu provides only viewing functionality.

Supported Channel types	Supported units
Velocity	m/s, ft/s
Depth	m, ft
Flow rate	L/s, L/h, kL/day, ML/day, m3/s, m3/h, gal/s, gal/min, gal/h, Mgal/day
Flow Total Net, permanent	L, kL, m3, ML, gal, Mgal, acre-in, acre-ft
Flow Total Net, resettable	L, kL, m3, ML, gal, Mgal, acre-in, acre-ft
Flow Total Positive only, permanent	L, kL, m3, ML, gal, Mgal, acre-in, acre-ft
Flow Total Positive only, resettable	L, kL, m3, ML, gal, Mgal, acre-in, acre-ft
Flow Total Negative only, permanent	L, kL, m3, ML, gal, Mgal, acre-in, acre-ft
Flow Total Negative only, resettable	L, kL, m3, ML, gal, Mgal, acre-in, acre-ft
Battery Voltage	V

Supported Channel types	Supported units
External Voltage	V
Stream index	none

3. Within the HydroVu platform, data is stored in an array consisting of the XCi [Site ID](#) and its related user-defined HydroVu location set in the "**HydroVu header information**" box. The "**Location**" can be re-named by left-clicking on the current location name and entering a new name. The "**Location**" should be something "meaningful" to the user. In the example below, "**Location 1**" has been re-named "**Pump XYZ**".

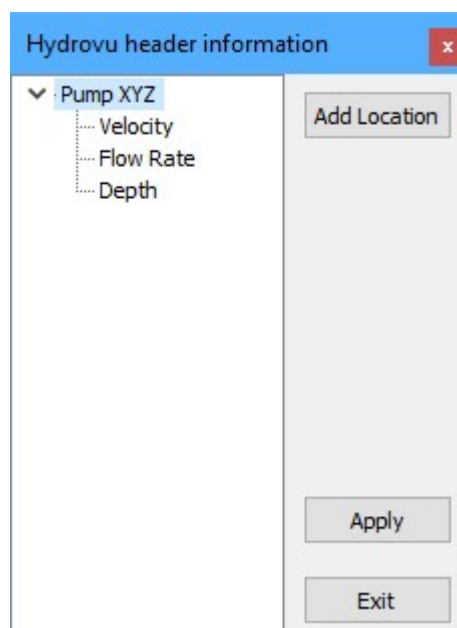

4. Further locations can be added by clicking on the "**Add location**" menu item.
5. "**Channels**" can be moved to a different "**Location**" by dragging and dropping onto a "**Location name**".

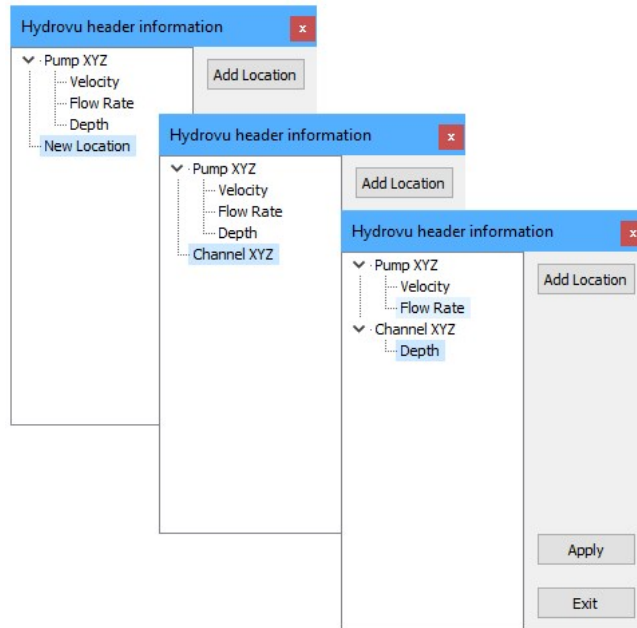

NOTE: A "Location" may only have a single instance of a particular "Channel type".

6. Click "**Apply**" and then "**Exit**" to return to the "**Device settings dialog**".



NOTE: Empty "Locations" will be removed from the "Header information" upon "Applying".

The "WebComm Utility"

This utility provides the user with a simple diagnostic interface to communicate with the WebComm card in order to test the settings and initiate a data upload on the MACE data server. The utility also has an handy feature that enables direct AT command communication with the modem.

From the "**Device settings**" dialogue box click "**WebComm utility**" and the "**WebComm utility**" dialogue box will appear.

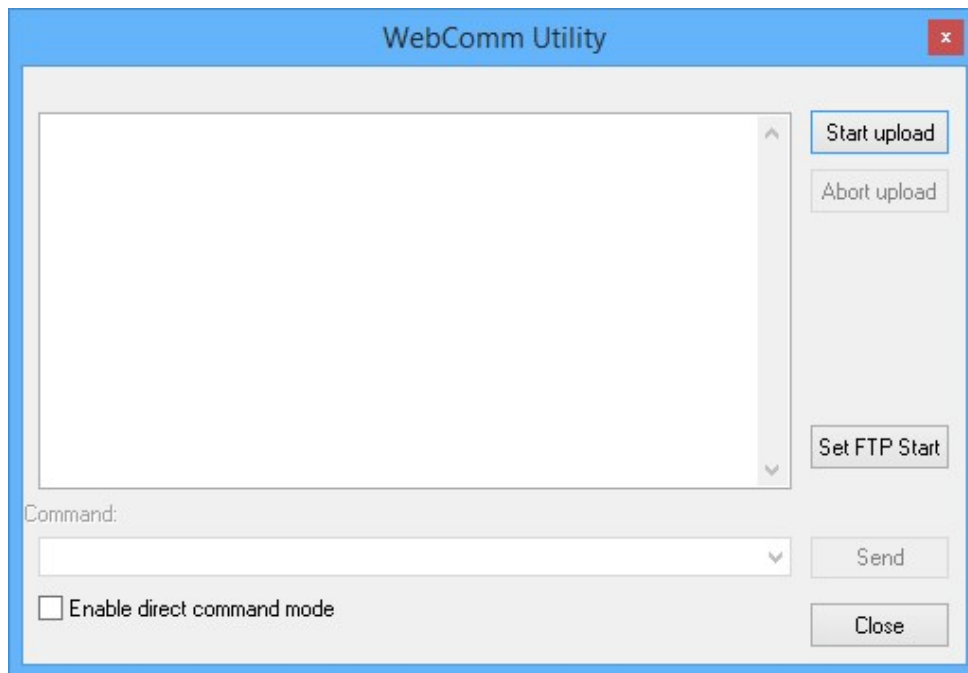

NOTE: The "*Set FTP Start*" will only appear if FTP uploads have been enabled.

Test an *HTTP Upload*



NOTE: If this is your first "*Upload*", you may need to run the "[*Initial upload routine*](#)" described below

1. Click "**Start upload**" and the utility will "force" the WebComm card to talk to the data server and upload any data stored in the log. A successful upload will be completed if all the "**Settings**" in the WebComm card have been entered correctly and there is a cell network in range with sufficient signal strength.



NOTE: The “*Signal strength*” is a measure between 0 and 30. For reliable uploads a “*Signal strength*” of at least 10 should be attained. If a “*Signal strength*” of 10 is not attained, then a higher gain antenna should be used.

2. If “**Upload completed successfully**” then click “**Close**” to exit from the WebComm utility. “**Start**” the device as described in [Start/Stop HydroMACE XCi device](#) after the device has been fully configured. Your data will now be uploaded regularly to the data server for storage and available for retrieval at www.macemeters.com

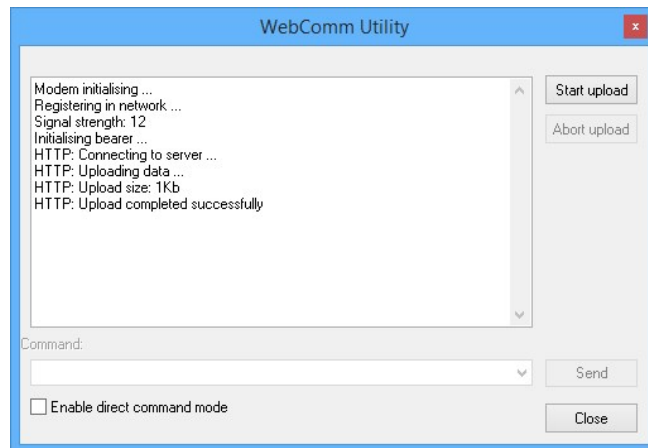

3. If the upload was not successful refer to the “[Error messages table](#)” to troubleshoot the WebComm card.

Test an *FTP Upload*



NOTE: If this is your first “*Upload*”, you may need to run the “[Initial upload routine](#)” described below

1. Click “**Set FTP Start**” and enter the start time from which the WebComm card will upload data stored in the log.

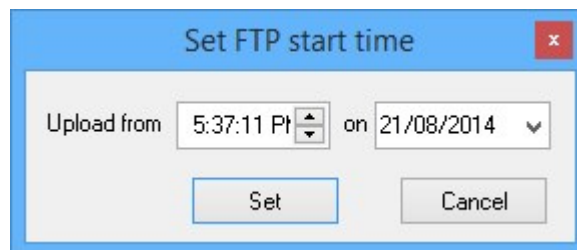

- Click "**Start upload**" and the utility will "force" the WebComm card to talk to the FTPserver and upload any data stored in the log. A successful upload will be completed if all the "**Settings**" in the WebComm card have been entered correctly and there is a cell network in range with sufficient signal strength.

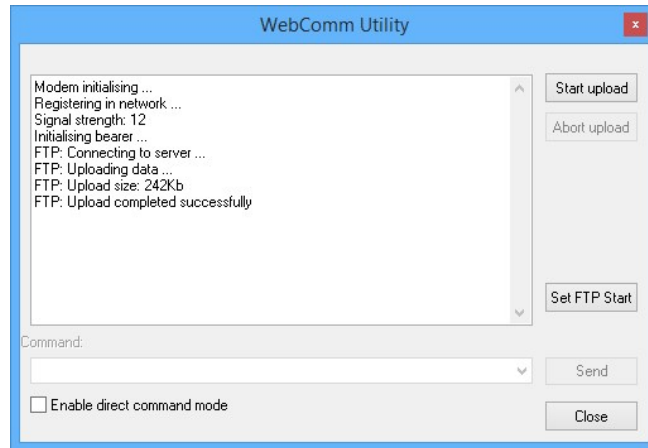

- If "**Upload completed successfully**" then click "**Close**" to exit from the WebComm utility. "**Start**" the device as described in [Start/Stop HydroMACE XCi device](#) after the device has been fully configured. Your data will now be uploaded regularly to the FTPserver for storage.
- If the upload was not successful refer to the "[Error messages table](#)" to troubleshoot the WebComm card.

Error messages table:

Error message	Possible cause	Remedy
Didn't register in network	No cell network available	Check with cell provider that you are in a coverage zone
	Wrong cell network	Check with cell provider that you are in a coverage zone
	Low cell signal strength	Check the antenna connection. Run signal strength command in WebComm utility (AT+CSQ). A high gain antenna may need to be installed in low signal strength areas
	Antenna not connected	Ensure antenna connected properly

Error message	Possible cause	Remedy
	Incorrect modem band	Run band check command in WebComm utility (AT+WMBS?). Ensure the correct band for your location is set. WebComm Gen1 <u>only</u>
Bearer error	Network busy	Wait, try again
	Low cell signal strength	Check the antenna connection. Run signal strength command in WebComm utility (AT+CSQ). A high gain antenna may need to be installed in low signal strength areas.
	Incorrect settings in the WebComm card	Check bearer settings with cell provider
HTTP authentication error	Incorrect username or upload key	Check username and upload key and correct if necessary
CMEE error	Probable modem not initialised error	Wait, try again
Data limit reached	WebComm will only upload ~100Kb at a single upload	" Force " another upload, or " Start " the device (Start/Stop HydroMACE XCi device) and the WebComm will "catch-up" over subsequent upload periods
Error connecting to server	Incorrect setting in WebComm card	Check the server URL (Configure a WebComm card using FloCom+)
No SIM	No SIM installed	Install SIM card (Preparing and installing a Webcomm card)
Socket timeout	Timeout during socket transaction	Wait, try again
Network timeout	Network busy	Wait, try again
HTTP XXX	Error communicating with server	Try again. If error persists con-

Error message	Possible cause	Remedy
		sult MACE vendor for assistance (see also List of HTTP status codes)
Modem error 0	Modem didn't activate	Wait, try again
Modem error 1	Modem didn't respond to a command	Wait, try again

Using "AT+ commands" to troubleshoot a WebComm card

This WebComm utility has a "**Command**" field where AT+Commands can be input to troubleshoot various parameters of the WebComm card. These AT+Commands are accessed via the drop down menu of the "**Command**" field or by direct input.



NOTE: Check "*Enable direct command mode*". This enables the modem for direct communication via AT+Commands

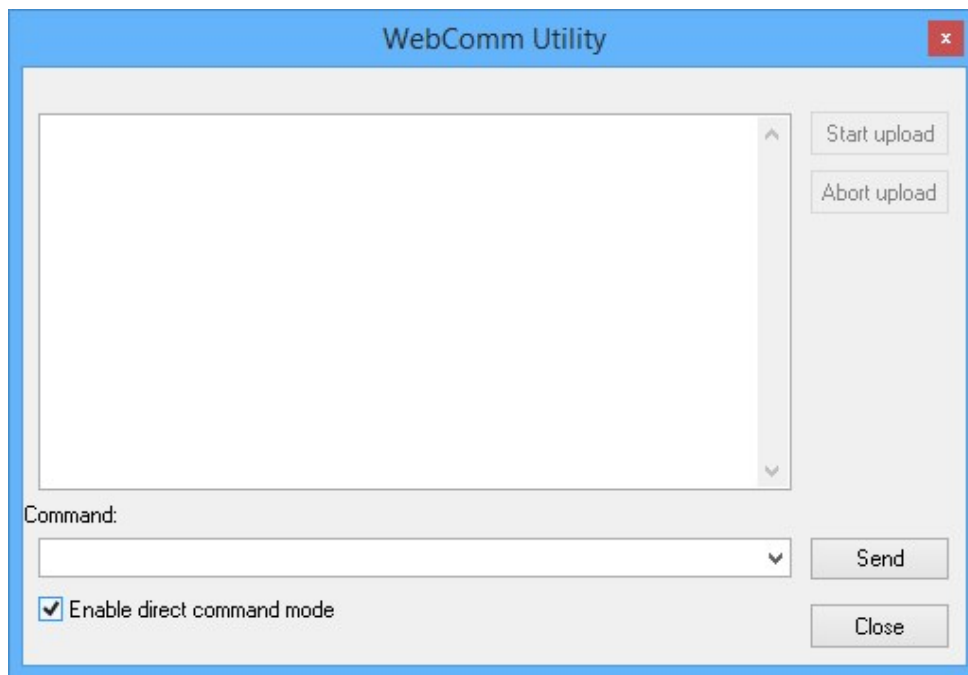

Initial upload routine:

1. After checking the "**Enable direct command mode**" box, wait until you see:
+CREG: 1
+CGREG:1
#QSS:3

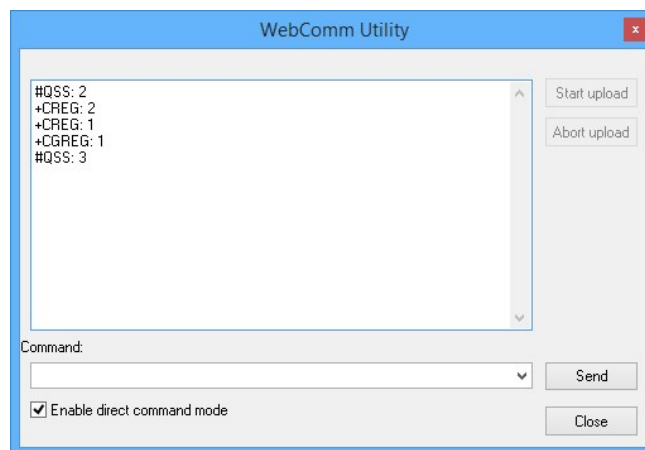

NOTE: The modem may take up to 2 minutes to register in a network for the first time. This is initialising the SIM card and is normal. Future registration attempts will be quicker.



NOTE: You may see +CREG:5 instead of +CREG:1 if you have a cell provider that "roams" on another network.

2. Type "**AT+COPS?**" into the command field and click "**Send**". The modem will respond with the current network identifier.

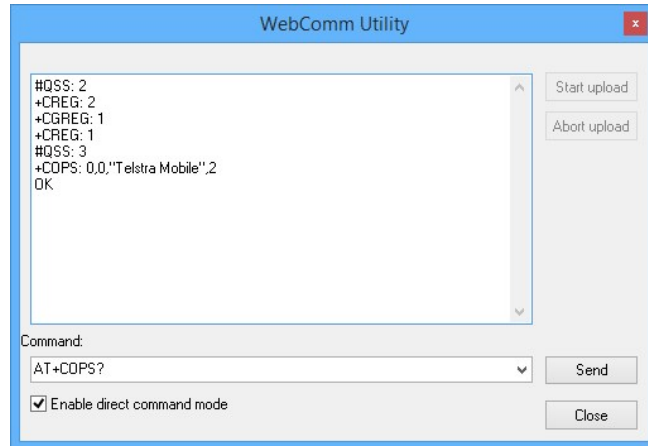

In the example above, the modem is connected on the "Telstra Mobile" network in Australia. In the USA, a network may identify with "T-Mobile" or "AT&T"

3. The SIM has been initialised and a normal "**Upload**" should be carried out as shown above.

Common AT+ commands

AT+ Command	Description
ATI9	WebComm Gen1 ONLY. MACE internal diagnostic use
AT+CSQ	Used to verify the Received Signal Strength

AT+ Command	Description															
	<p>Enter the AT+command " AT+CSQ " and click " Send "</p> <p>The response returned has the following format: +CSQ: <rsssi>,<ber> with:</p> <ul style="list-style-type: none"> • <rsssi> = received signal strength indication, • <ber> = channel bit error rate. <p>Verify the <rsssi> value returned using the values below:</p> <table border="1"> <thead> <tr> <th>Value</th> <th>of received signal strength indication (<rsssi>)</th> <th></th> </tr> </thead> <tbody> <tr> <td>0</td> <td>-</td> <td>10 Insufficient</td> </tr> <tr> <td>11-</td> <td>31</td> <td>Sufficient</td> </tr> <tr> <td>32-</td> <td>98</td> <td>Not defined</td> </tr> <tr> <td>99</td> <td colspan="2">No measure available</td> </tr> </tbody> </table>	Value	of received signal strength indication (<rsssi>)		0	-	10 Insufficient	11-	31	Sufficient	32-	98	Not defined	99	No measure available	
Value	of received signal strength indication (<rsssi>)															
0	-	10 Insufficient														
11-	31	Sufficient														
32-	98	Not defined														
99	No measure available															
AT+CREG?	<p>Used to verify the registration on the network</p> <p>Enter the AT+command " AT+CREG ?" and click " Send "</p> <p>The format of the returned response is as follows: +CREG: <mode>,<stat> with:</p> <ul style="list-style-type: none"> • <mode> = unsolicited registration message configuration, • <stat> = registration state. <p>Verify the state of registration according to the returned value:</p> <table border="1"> <tbody> <tr> <td>+CREG: 0,0</td> <td>Not registered, no registration attempted</td> </tr> <tr> <td>+CREG: 0,2</td> <td>Not registered, registration attempted</td> </tr> <tr> <td>+CREG: 0,1</td> <td>Yes registered, home network</td> </tr> <tr> <td>+CREG: 0.5</td> <td>Yes registered, roaming</td> </tr> </tbody> </table> <div style="border: 1px solid #ccc; padding: 10px; margin-top: 10px;">  <p>NOTE: If a registration is not successful then the cell network provider does not have coverage in this area or the modem is set to the incorrect band for your network provider</p> </div>	+CREG: 0,0	Not registered, no registration attempted	+CREG: 0,2	Not registered, registration attempted	+CREG: 0,1	Yes registered, home network	+CREG: 0.5	Yes registered, roaming							
+CREG: 0,0	Not registered, no registration attempted															
+CREG: 0,2	Not registered, registration attempted															
+CREG: 0,1	Yes registered, home network															
+CREG: 0.5	Yes registered, roaming															
AT+COPS=?	Forces the modem to initiate a "network scan" listing the networks in an area.															

AT+ Command	Description
	<p>Enter the AT+command " AT+COPS=? " and click " Send "</p> <p>The response will include the identifiers of all networks in an area: Eg. (2,"Telstra Mobile", "50501",2), (2,"Telstra Mobile", "50501",0), (3,"YES OPTUS", "50502",2), (3,"YES OPTUS", "50502",0), (3,"vodafone AU", "50503",2), (3,"vodafone AU", "50503",0), (0-4), (0,2)</p>
AT+COPS?	<p>Used to verify the identity of the network that the WebComm is connected too.</p> <p>Enter the AT+ command " AT+COPS? " and click " Send "</p> <p>The modem will respond with the network identifier to which it is currently connected.</p> <p>Eg. +COPS: 0,0,"Telstra Mobile",2</p>
AT#AUTOBND	<p>Used to enable or disable the automatic band selection at power on.</p> <p>AT#AUTOBND= [value] Set</p> <p>AT#AUTOBND? Read</p> <p>AT#AUTOBND=? Test</p> <p>Value:</p> <p>0 Disables automatic band selection at next power - up.</p> <p>1 Enables automatic band selection at next power -up. The automatic band selection stops as soon as a GSM cell is found (deprecated).</p> <p>2 Enables automatic band selection in four bands (at 850/1900 and 900/1800); differently from previous settings it takes immediate effect. Default: 2.</p> <p>Consult MACE for further details on band selection</p>

Editing/Viewing a WebComm site on the web

1. "**Login**" to www.macemeters.com with your "**User Login**" and "**Password**". Navigate to the "**WebComm**" page.
2. Click on the "**Site ID**" hyperlink on the "**My sites**" tab sheet of the WebComm site you wish to view/edit and you are directed to the "**Site information**" page.

All times shown on this page are site local time.
Your current alarm credit is 48 alarms.

Site ID	Site Description	Latest Record
XCi	MAC Test Bench	2014-11-08 11:48:00

[Back to top](#)

3. The "**Site information**" page is divided into two sections:

Site data

Site data

Download site data	Show latest record	Delete site data
Site ID: XCi		
Site description: MAC Test Bench		
Last record downloaded: 2014-11-07 15:27:00		
Suppress status messages: <input type="checkbox"/>		
Enter start date: 2014-11-07 15:27:01	Enter end date:	
YYYY-MM-DD or YYYY-MM-DD HH:MM:SS Leave blank for all data	YYYY-MM-DD or YYYY-MM-DD HH:MM:SS Leave blank for all data	
<input type="button" value="View site data"/>	<input type="button" value="Download site data"/>	

[Back to top](#)



NOTE: The MACE data server will store up to 500Mb of data per "**Site ID**". When this quota is reached uploads are no longer accepted. Ensure data that you wish to keep is downloaded.

Download site data

1. Enter a "**Start date**" and an "**End date**" (in the required format), or alternatively, just leave the fields blank if you wish to download all available site data. By default, the "**Start date**" is pre-determined by the date of the last record downloaded.
2. Check the "**Suppress status messages**" box if you wish to download only time stamped XCi channel data without the [Status messages](#).
3. Click "**Download site data**", to download the data in the format "**SiteID.CSV**".

4. Click "**View site data**" to view site data as text on your computer screen.



NOTE: When "**View site data**" is used, large data files will not be displayed completely. In that instance a message - "**!DataServer, "Due to size limits not all requested data has been returned."**" will be displayed

Show latest record

1. Click on the "**Show latest record**" tab to view the latest timestamped data record uploaded to the data server from this "**SiteID**"

Site data

Download site data	Show latest record	Delete site data
Timestamp: 2014/11/08 12:24:00 Velocity: 0.921 m/s Depth: 0.128 m Flow Rate: 2.966 Ml/day Total: 1.774 Ml		

[Back to top](#)

Delete site data

1. Click on the "**Delete site data**" tab to initiate the data deletion procedure.

Site data

Download site data	Show latest record	Delete site data
Site ID: XCi Site Description: MAC Test Bench		
You are about to delete data for this site: <ul style="list-style-type: none">• Before deleting site data you should make sure it has been downloaded.• MACE makes no guarantees that deleted data will be recoverable from backups.• If backup data is requested and is available a fee will be charged for its retrieval.		
NOTE: This site has additional users that have not downloaded any stored data for this site.		
<input type="radio"/> Delete data downloaded by the site owner. Data older than 2014-11-07 15:27:00 will be deleted.		
<input type="radio"/> Delete data older than this date: 2013-11-07 00:00:00 Valid date formats (site local time): YYYY-MM-DD or YYYY-MM-DD HH-MM-SS		
<input type="radio"/> Delete data newer than this date: 2014-11-08 12:24:00 Valid date formats (site local time): YYYY-MM-DD or YYYY-MM-DD HH-MM-SS <input type="checkbox"/> Force this data to be download again if it is available.		
<input type="button" value="Delete site data"/>		

[Back to top](#)

2. Check the radio button for the selected data you wish to delete.



NOTE: The first method of data deletion will not be available if no data has been previously downloaded.

Site details

Site details

Site details | Site keys | Site alarms | Site users | Remove site | Alarm history

Last update: 2014-11-08 12:18:53 [Edit site details](#)

Site ID:	XCi
Site Timezone:	(UTC+10:00) Australia Eastern Time
Site Description:	MAC Test Bench
Site Access:	MACE support staff have access to this site. Data from this site can be downloaded directly from the MACE data server.
Oldest data record:	2013-11-07 00:00:00
Last record uploaded:	2014-11-08 12:18:00
Server storage used:	2.4 MB
Device type:	FloPro
Serial number:	123456
Firmware:	V3.06.10
Signal strength:	13
Battery status:	OK
Battery voltage:	12.47V
External voltage:	0.35V

[Back to top](#)

Site Details

The "**Site details**" tab sheet, gives you an overview of the XCi device in the field and its stored records on the database.

Click "**Edit site details**" to change any of the editable details ([Add a WebComm site on the web](#)).



NOTE: The MACE data server will store up to 500Mb of data per "Site ID". When this quota is reached, uploads are no longer accepted. Ensure data that you wish to keep is downloaded.



NOTE: The MACE data server will store data for each "Site ID" for 12 months after upload. After the 12 month period, the data will be scheduled for deletion by the data server. Ensure data that you wish to keep is downloaded. A message will be displayed on the website warning that data will be deleted in due course.

Oldest data record: 2013-11-08 00:00:00 NOTE: This site has data scheduled for deletion that has not been downloaded.

Site keys

Site details

Site details Site keys Site alarms Site users Remove site Alarm history

Device upload configuration

These parameters must be entered into the device configuration before data can be uploaded.

Username: UserName	Edit username in your profile
Site upload key: BLUW-JFPY-E4MC	Change upload key
	Save upload details to a text file

Device download configuration

These parameters must be used when downloading site data directly from the MACE data server. You do not need to use these parameters if you are downloading your data via this website.

Username: UserName	Edit username in your profile
Site download key: There is no download key set for this site	Set download key

Back to top

The "**Site keys**" tab sheet, gives you the authentication details necessary for the XCi device to upload data to the MACE data server, as well as the details for download via a third-party software program.

Should your authentication details be compromised, click "**Change upload key**" to generate a new set.

Site alarms

See [Edit Alarms](#)

Site users

Site details

Site details Site keys Site alarms Site users Remove site Alarm history

Adding a user to a site will allow them to download the site's data.

Enter the email address of the user you wish to add

username@user.com

Note: The user you are adding must be a registered user of this website.

Add site user

Cancel

Back to top

Under certain circumstances, you may wish to "share" your data with other users. For example, a farm manager may wish his irrigation superintendent to also access site data.



NOTE: ONLY "Site Owners" can "Edit site details", or "Delete site data". ONLY "Site Owners" can add site users.



NOTE: "Site users" MUST be registered users of the MACE website.

1. Click on "**Add site user**" from the "**Site users**" tab sheet.
2. Enter the email address of the user that you wish to add and click "**Add site user**".

Remove site

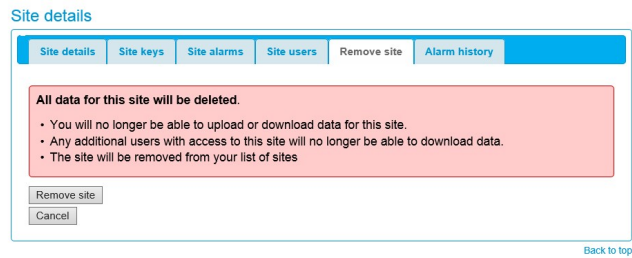

Click on **“Remove site”** from the **“Remove site”** tab sheet.



WARNING: Ensure that you have downloaded all the data that you wish to retain PRIOR to site removal.

[Alarm history](#)

See [Alarm history](#)

All about Webcomm SMS/Email alarms

With the introduction of the MACE WebComm card, the MACE FloSeries3 and/or XCi devices have the ability to upload data to the MACE Data Server on a user-configurable interval for viewing and retrieval on the MACE website (www.macemeters.com/www.macusa.com). The user is also able to configure SMS and email text alarms based on uploaded site data. Some examples:

1. An alarm can be configured based on “**Flow Rate**” to notify the user that a pump has stopped pumping (when the flow rate is zero).
2. An alarm can be configured based on “**Total**” accumulation to notify the user that a certain amount of water has been pumped.
3. An alarm can be configured based on “**Depth**” to notify the user that a river is no longer deep enough for water to be extracted.
4. An alarm can be configured based on “**Rain**” accumulation to notify the user that an amount of rain has fallen.
5. An alarm can be configured to notify the user that their WebComm card has “**stopped**” uploading.

Really, the options for alarm configurations are only limited by the sensor/s that the user has connected to their XCi device.



WARNING: As with any cellphone technology, alarms sent from the MACE Data Server should not be relied upon for “critical” information, particularly in areas with limited cellphone coverage.

Getting started

Follow the instructions for installing a WebComm card ([About the WebComm card](#)) and configuring the card and the website for data uploads ([Add a WebComm site on the web](#), [Configure a WebComm card using FloCom+](#)) In order to configure alarms, the device in the field must be commissioned, and at least one upload must have been received by the MACE Data Server (either from a scheduled upload or one “forced” by FloCom+). This first upload allows the channel structure to be assigned by the data server so that the alarm configuration procedure can be followed.

Enable alarm usage

1. Login to your **www.macemeters.com** account.
2. Navigate to the “**WebComm settings**” tab sheet in “**My details**”

My details	Mailing lists	Webcomm settings	Change password
Username: UserName			Change
SMS phone number: 6112345678			Change
SMS alarms: Receiving SMS alarms is enabled.			Disable
Email alarms: Receiving email alarms is enabled.			Disable
Alarm credits: 5			Purchase
Auto credit renewal: You have auto alarm credits disabled. If you run out of credit alarms will not be sent.			Enable

- The settings here are used for all Webcomm sites you own, have access to or are configured to send alarms to you.
- The phone number above is used for all SMS alarms that are configured to send messages to you.
- If you disable alarms here **you will not receive** messages from any Webcomm sites.

In this tab sheet, you must:

- a. Enter the SMS phone number at which you wish alarms to be sent.



WARNING: You must enter your full phone number including your country code or SMS alarms WILL NOT work

- b. Enable SMS alarms (if required) by clicking the "**Enable**" link
 - c. Enable Email alarms (if required) by clicking the "**Enable**" link
3. In order to receive alarms (both SMS and email) you must first buy alarm credits by clicking on the "**Purchase**" link and following the directions. If no credit is available on a user account, alarms will be shown in "**Alarm history**" as "**No credit**". See section on "Alarm history" for further details.
4. "**Enable**" "**Auto credit renewal**" if desired. "**Auto credit renewal**" ensures that alarms can always be sent from your account.
5. Navigate to the "**WebComm**" page and the "**My Sites**" tab sheet will appear listing all your currently configured WebComm Sites.
6. Open the site for which you wish to configure alarms by clicking the "**Site ID**" and the "**Site information**" page will open.
7. In the "**Site details**" area of the page click on the "**Site alarms**" tab sheet

Alarm configuration

1. From the "**Site alarms**" tab sheet, click on "**Add alarm**" and a new alarm can be setup.
2. Select the "**Alarm type**" from the drop-down list and click "**Next**":

For each alarm type, a form similar to that shown below will appear:

Site details

Site details	Site keys	Site alarms	Site users	Remove site	Alarm history
Alarm description:	<input type="text" value="Send an alarm when a channel is above a value"/>				
Channel to use for this alarm:	<input type="text" value="Velocity"/>				
Send the alarm when the channel value is above :	<input type="text" value="1.0"/> This value triggers the alarm				
Clear the alarm when the channel value is below :	<input type="text" value="0.75"/> This value clears the alarm				
After the alarm has been sent disable it for:	<input type="text" value="1 day"/> This prevents the alarm triggering too often				
Send an SMS message to these phone numbers:	<input type="text" value="6112345678"/> OK (Test Site) Add another phone number Leave blank for no SMS message. Use full phone numbers including the international country code. Only phone numbers for registered users of this website will be accepted.				
Limit SMS message size:	<input type="text" value="160 characters (1 alarm credit per recipient)"/>				
Send an email message to these addresses:	<input type="text" value="macefco2001@yahoo.co.uk"/> OK (Test Site) Add another email address Leave blank for no email message. One alarm credit per email recipient. Only email addresses for registered users of this website will be accepted.				
Message:	<div style="border: 1px solid #ccc; padding: 5px;"><p>Alarm from [siteid] at [timestamp] The [channelname] is [channelvalue][channelunits] This is the alarm message text</p></div>				
Special strings:	<p>[date] Substitutes the date the alarm occurred (YYYY-MM-DD). [time] Substitutes the time the alarm occurred (HH:MM:SS). [timestamp] Substitutes the timestamp the alarm occurred (YYYY-MM-DD HH:MM:SS). [timestamplatestrecord] Substitutes the timestamp of the last record uploaded. [channelname] Substitutes the name of the channel that caused the alarm. [channelvalue] Substitutes the value of the channel that caused the alarm. [channelunits] Substitutes the units of the channel that caused the alarm. [siteid] Substitutes the site ID the alarm came from. [sitedescription] Substitutes the site description the alarm came from.</p>				
<input type="button" value="Save alarm details"/>					
<input type="button" value="Cancel"/>					

[Back to top](#)

Alarm description:

By default, the description is merely the “**Alarm type**” transposed. However, this description can be changed by the user to something more identifiable if desired.

Channel to use for this alarm:

Using the drop-down list of all the channels in your device that are available, select the channel for which you wish to configure an alarm.

Send the alarm when the channel value is **above/below**:

This is the value of the channel (set point) for which the alarm will be triggered. For example, if you wish to be notified when the velocity of a stream reaches 1m/s , then this is the value to enter here.

Clear the alarm when the channel value is **above/below**:

This is the value of the channel for which the alarm will be cleared. For example, if the stream (example above) triggers an alarm (at 1m/s), then NO further alarms will be sent for this UNTIL the clear point is reached (0.75m/s). After this time, if the stream meets the alarm conditions again, it will trigger a new alarm. See also [After the alarm has been sent disable it for](#):

Add this value to alarm set point each time the alarm occurs:

For a “**Total channel change**” alarm, this is the value that will be added to the alarm trigger point in

order to “re-trigger” the alarm. For example, if an irrigation pump has been started when 0 ML is on the totaliser and you wish to be alarmed whenever there has been 50 ML pumped, the “**Send the alarm.....above**” should be set at 50 and then the “**Add this value....occurs**” should also be set at 50. With this function irrigators can be notified when to shut off pumps/close gates etc.

[After the alarm has been sent disable it for:](#)

When an alarm has been sent, this “**Disable**” function means that the alarm will not be re-sent for the period of time selected from the drop-down list. For example, if the velocity reaches 1m/s and you do not wish to be alarmed again one day, then “**1 day**” would be selected from the drop-down list. If the alarm is cleared (via the “**Clear**” set point described above) and then re-triggered, an alarm WILL NOT be sent again until the one day period is over.

[Send an SMS message to these phone numbers:](#)

Alarms can be sent as SMS messages to mobile phones. An unlimited number of phone number recipients can be added to an alarm. FULL phone numbers including international country code must be entered in the field provided. Leave the form blank if you do not wish to send SMS alarms



WARNING: The recipients of SMS alarms from the MACE Data Server MUST be registered users of the MACE website.

[Limit SMS message size:](#)

When configuring an alarm, the number of credits used to send the particular alarm can be ascertained and limited:

- Each SMS of 160 characters or less = 1 alarm credit per recipient
- Each SMS of 161-306 characters = 2 alarm credits per recipient
- Each SMS of 307 - 459 characters = 3 alarm credits per recipient

[Send an email message to these addresses:](#)

Alarms can be sent as email messages. An unlimited number of email recipients can be added to an alarm. Enter the email address of the alarm recipient in the field provided. Leave the form blank if you do not wish to send email alarms



WARNING: The recipients of email alarms from the MACE Data Server MUST be registered users of the MACE website.



NOTE: Each email regardless of number of characters = 1 alarm credit per recipient.

Message:

Enter in the field provided the message that you wish to be sent (via SMS or email) when the alarm occurs. The default message is:

Alarm from [siteid] at [timestamp].

The [channelname] is [channelvalue][channelunits].

For example, on a mobile phone the message will look like this:

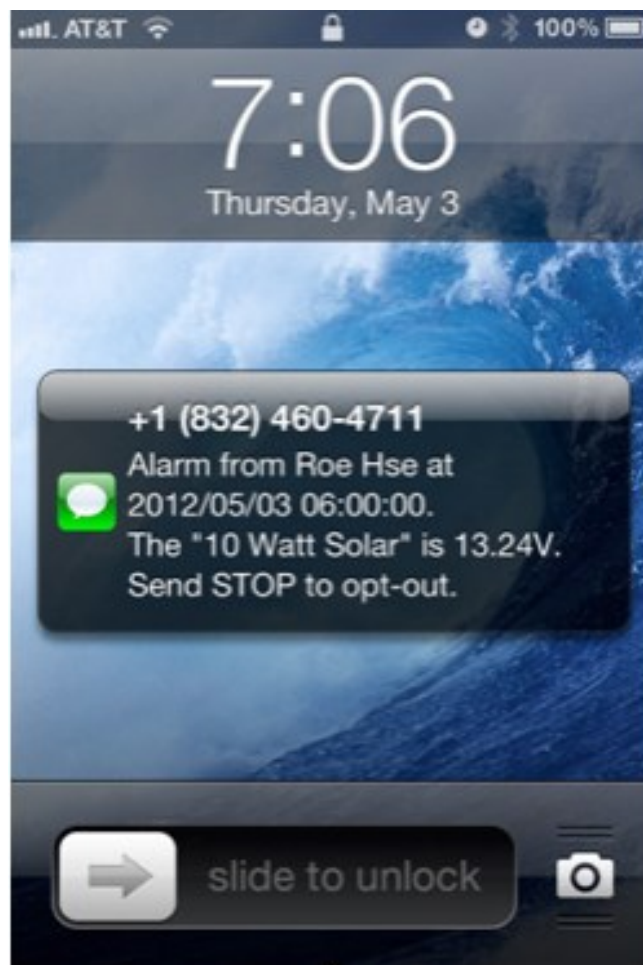



WARNING: For users in USA: Users in the USA will receive SMS messages (like the above) that will give an “Opt-out” option by replying with “STOP”. If this is sent, ALL SMS alarms for ALL sites on the MACE Data Server will be BLOCKED and SMS alarms will cease. MACE recommends setting the phone number +18324604711 as a contact “MACEMETERS” in your cell phone so that you are aware of the SMS origin and do not reply “STOP” by mistake. If SMS alarms have been blocked, the user can send a message “SUBSCRIBE” to the phone number +18324604711 to re-enable.

For example, an email message received will look like this:

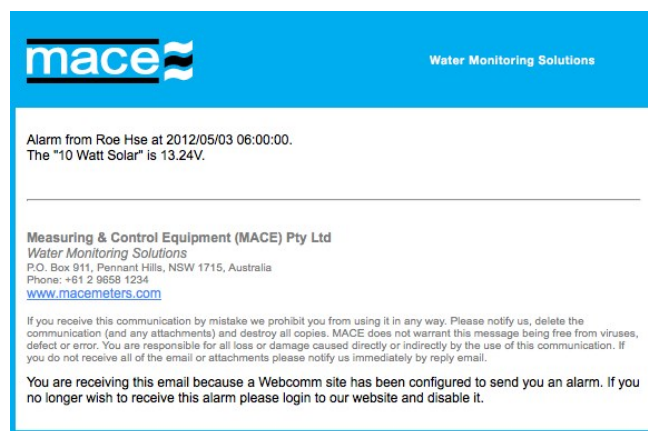

3. Once the alarm has been configured click **“Save alarm details”**.

Alarm state

Once alarms have been configured, the alarms will appear on the **“Site alarms”** tab sheet with their current **“State”**.

Site details

State	Alarm type	Channel name	Set point
Active	Send an alarm when a channel is above a value	Velocity	0.9
Waiting	Send an alarm when a total channel changes	Total	50
Waiting	Send an alarm when a status message occurs		

Back to top

There are four (4) different alarm states:

Active:

The “**Active**” alarm state occurs when the alarm has been triggered. It will stay in this state until the alarm is cleared by reaching the “**Clear setpoint**”. An “**Active**” alarm will have the “**State**” highlighted in a **RED** box.

Waiting:

The “**Waiting**” alarm state occurs when the alarm trigger point has not yet been met. When the alarm set point is reached, the alarm state will change to “**Active**”.

Sleeping:

The “**Sleeping**” alarm state occurs when an alarm has been disabled via the “**After ... sent disable it for**” function (see [After the alarm has been sent disable it for:](#)).

Disabled:

The “**Disabled**” alarm state occurs when an alarm has been permanently disabled via the “**Disable this alarm**” function available when an alarm is edited. See ([Edit Alarms](#)

Edit Alarms

Alarms can be edited after initial configuration by clicking on the hyperlink in the “**Alarm state**” field (such as “**Active**”).

Site details

Site details	Site keys	Site alarms	Site users	Remove site	Alarm history
Alarm details					
Remove this alarm Disable this alarm Edit this alarm Back to alarm list					
Description:	Send an alarm when a channel is above a value				
Channel used:	Velocity				
Send the alarm when the channel value is above:	0.9				
Clear the alarm when the channel value is below:	0.85				
After the alarm has been sent it is disabled for:	1 day				
Number of credits for this alarm:	2				
Message:	Alarm from [siteid] at [timestamp]. The [channelname] is [channelvalue] [channelunits].				

In the “**Alarm details**” information page, there are four buttons that can be used to:

Remove this alarm

Will permanently **remove** the alarm from the site.

Disable this alarm

Will **disable** the alarm from the site without removal.

Enable this alarm

Will **enable** an alarm that had been disabled by the user.

Edit this alarm

Allows the alarm values and recipients to be changed if necessary.

[Back to alarm list](#)

Navigates to previous “**Site alarms**” tab sheet.

Alarm history

The “**Alarm history**” tab sheet provides the user an “audit trail” of the alarms that have been triggered and their recipients for each “**Site ID**”.

Click on the “**Timestamp**” hyperlink for the alarm of choice and jump to the full details of the alarm:

Site details

[Site details](#) | [Site keys](#) | [Site alarms](#) | [Site users](#) | [Remove site](#) | [Alarm history](#)

Alarm event details [Back to alarm history list](#)

Description: Send an alarm when a channel is above a value
Channel used: Temp.
Date set: 2012-05-15 12:00:00
Set point: 21.500 C
Set value: 21.600 C
Message: Alarm from MACDural at 2012/05/15 12:00:00.
The "Temp." is 21.6C.
Credits used: 3

Recipient	Sent to	Status
Mathew Campbell	123456789000	SMS received by recipient.
Mathew Campbell	sales@macemeters.com	Email sent.
Tim Quinlan	123456789111	SMS received by gateway.

[Back to top](#)

The “**Alarm history**” information relates the date/time at which the alarm was set and the date/time it was reset.

The recipient information tells where the alarm was sent (SMS and/or email) and the “**Status**” of the message sent.



WARNING: SMS alarms are sent via an SMS gateway. Status messages are dependent upon the carrier. A status that is “received by gateway” indicates successful transmission by the MACE Data Server. This does not guarantee that the carrier has relayed the SMS alarm to the recipient.

The FloSI card

About the FloSI card

The FloSI (Serial Interface) card provides an SDI-12 or ModBus output to interface an XCi device to SCADA systems. This card provides unconditional polling access to the most recent user configured measurement results of XCi devices.

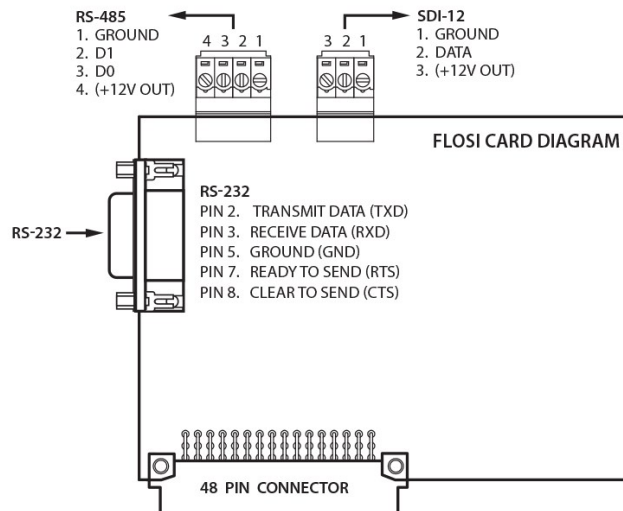

NOTE: Only one FloSI per XCi device is supported

RS-232, RS-485 and SDI-12, interfaces are available from the XCi device with the use of a FloSI. The FloSI enables users to request the last measurement from The XCi device without the complexity of communicating via the host communications port.

The FloSI cannot be used to download or configure a XCi device, and only one serial protocol may be used at one time.

Wiring a FloSI card

After installing the FloSI card (see [Installing FloSeries3 Cards](#)), connect it to the remote device using either:

1. The 9-pin d-connector (RS232, ASCII or RS232 ModBUS) for RS232;



WARNING: Depending upon the type of remote device, a null modem cable may be required for RS232 communication.

2. The 4-way terminal block for RS485 ModBUS mode;
3. The 3-way terminal block for SDI-12 mode.

Pin out details for the various connectors are printed on the back of the FloSI card and shown in the diagram in [About the FloSI card](#)

Once a remote device has been wired to the FloSI card it must be configured using FloCom+ software so that the XCi device can provide access to it's measurement results.

Serial interface settings

The FloSI can only be configured to use one serial protocol from the three available. The parameter values are provided in the user configured units.

RS-232, ASCII mode

The line transmission characteristics are as follows:

- Baud rate: 9600
- Data bits: 8
- Parity: None
- Stop bits: 1

In this mode, the FloSI is dormant while RTS is inactive. On RTS going active, the FloSI transmits the most current result string from the XCi device. If RTS is active when a scheduled sample is made, then the string is transmitted immediately on completion of the measurement. The transmitted ASCII text string starts with the character '*' (asterisk), ends with a carriage return and contains the configured number of channel values. The number and order of channel values in the output string can be configured using FloCom+ Each channel value in the string always begins with either a '+' (plus sign) or '-' (minus sign) - there are no spaces between values.

SDI-12 mode

The SDI-12 implementation complies with V1.3 of the SDI-12 specification.

Configurable parameters are:

- Address ('0'-'9', 'A'-'Z', 'a'-'z')
- Which measurement results to provide

On receiving an SDI-12 Measurement command, the FloSI replies with notification that the measurement results are immediately available. Upon receiving a Send Data command, the FloSI returns the currently available result data which it has been configured to provide.

The following SDI-12 commands are supported:

<i>Name:</i>	<i>Command:</i>	<i>Response:</i>
Acknowledge active	a!	a<CR><LF>
Send Identification	a!	a13MACE P/FloSI3100#n- nnnn<CR><LF>
Address Query	?!	a<CR><LF>
Start Measurement	aM!	a000n<CR><LF>
Start Measurement and Request CRC	aMC!	a000n<CR><LF>
Send data	aD0! to aD9!	a<values><CR><LF> or a<val- ues><CRC><CR><LF>
Additional Measurements	aM1! to aM9!	a0000<CR><LF>
Additional Measurements and Request CRC	aMC1! to aMC9!	a0000<CRC><CR><LF>
Start Verification	aV!	a0000<CR><LF>
Start Concurrent Measurement	aC!	a000n<CR><LF>
Start Concurrent Measurement and Request CRC	aCC!	a000n<CRC><CR><LF>
Additional Concurrent Measurements	aCC1! to aCC9!	a0000<CR><LF>
Continuous Measurement #0	aR0!	a<values><CR><LF>
Continuous Measurements #1 to 9	aR1! to aR9!	a<CR><LF>
Continuous Measurement #0 and Request CRC	aRC0!	a<values>< CRC><CR><LF>
Continuous Measurements #1 to 9 and Request CRC	aRC1! to aRC9!	a<values>< CRC><CR><LF>

MODBUS mode

The MODBUS implementation complies with the **MODBUS over Serial Line Specification V1.0** and **MODBUS Application Protocol Specification V1.1**.

The external port is either a standard “**RS232**” port or a two-wire “**RS485**” port, depending on the selected MODBUS mode. The MODBUS parameters are configurable by entering the appropriate “**Address**”, selecting the correct “**Baudrate**” from the drop down list and checking the required radio buttons

The screenshot shows a configuration window for MODBUS mode. The 'Current mode' is set to 'Modbus'. The 'Address' field is set to '1' with a range of '(1...247)'. The 'Transmission mode' has radio buttons for 'RTU' (selected) and 'ASCII'. The 'Hardware mode' has radio buttons for 'RS485' (selected) and 'RS232'. The 'Baudrate' is set to '19200' in a dropdown menu. The 'Parity' has radio buttons for 'None' (selected), 'Even', and 'Odd'. The 'Stop bits' has radio buttons for '1' (selected) and '2'.



WARNING: The user must ensure that there are no two devices with the same address on the same bus. In such a case, the behaviour of the bus is unpredictable.

Supported function codes:

<i>Command:</i>	<i>Code (hex):</i>	<i>Sub-code (dec):</i>
Read input registers	04	
Diagnostics	08	00-04, 10-18

Register map information:

- Twenty (20) register pairs are available - 30001-30002 to 30039-30040
- Register byte order is big-endian

- Registers are inverse float values
- Float values are formatted according to IEEE 744 32-bit representation
- Register size is 32-bit
- Flow total has a range from 0 to 999999.9

System registers:

The XCi device includes system registers that contain the following information:

Register pair	System information	Type
30101-30102	MACE Serial Number	(unsigned long integer)
30103-30104	System battery (Volts)	(4 byte big-endian IEEE 754 float value)
30105-30106	External voltage (Volts)	(4 byte big-endian IEEE 754 float value)

Configuring a FloSI card in FloCom+

1. Ensure at least one channel is configured.
2. From the “**Device settings**” dialogue box. Click the “**FloSI**” button and the “**FloSI settings**” dialogue box will appear.
3. Click “**Change**” and the “**Select output mode**” dialogue box will appear.
4. From the drop down list select the output mode you wish to use. Click “**Apply**” and the updated “**FloSI settings**” dialogue box will appear.

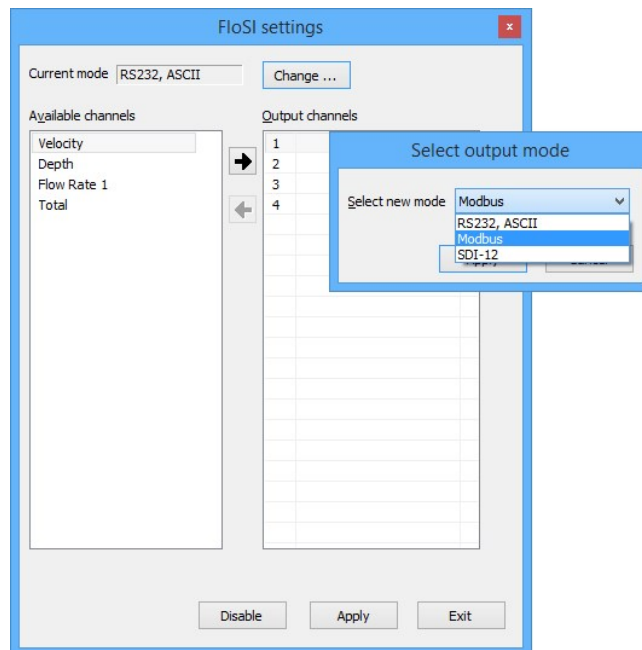

Ordering the SDI-12 or ASCII output string

The number and order of channel values in the output string for SDI-12 or RS232, ASCII output are configured using FloCom+

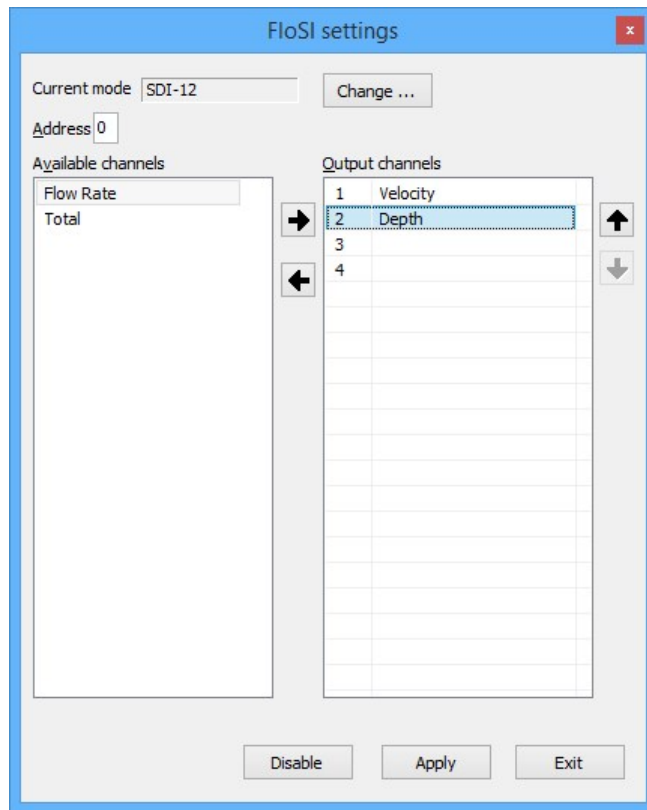

From the “*FloSI settings*” dialogue box, move the required channels from the “*Available channels*” table to the “*Output channels*” table by highlighting the desired channel in the “*Available channels*” table and clicking the “*Right arrow*”. If a channel in the “*Output channels*” table is no longer required, highlighting it and clicking the “*Left arrow*” will remove it from the “*Output channels*” table. The position of a channel in the “*Output channels*” table can be changed by highlighting the channel and clicking the “*up*” or “*down*” arrow.



WARNING: The user must ensure that there are no two devices with the same address on the same bus. In such a case, the behaviour of the bus is unpredictable.

Ordering and setting ModBus registers

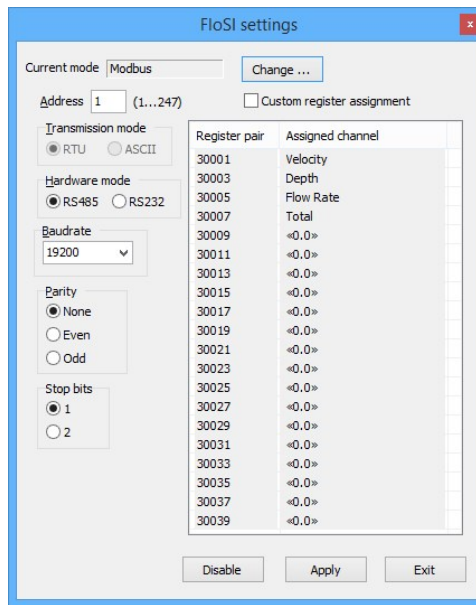

1. Register pairs are automatically assigned according to the channel order in which they have been added and ordered in the XCi configuration (see [Add XCi channels](#))
2. Check the "**Custom register assignment**" box to enable custom assignment of register pairs.

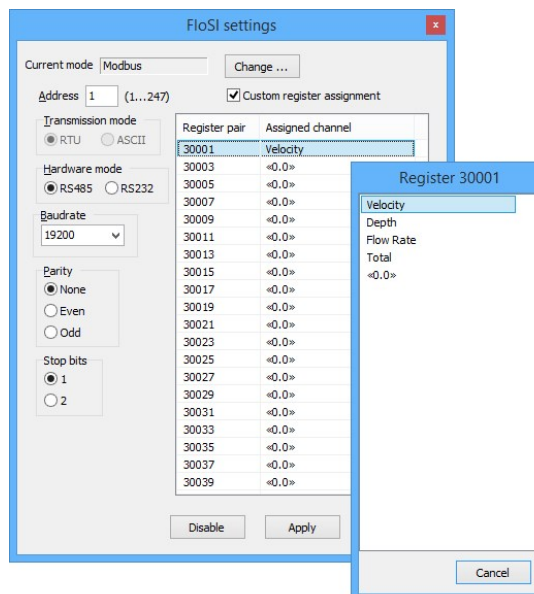

3. Left click on one of the register pairs and a new "**Register**" dialogue box will open that relates to the register pair.
4. Click on the desired channel to assign it to the register pair.
5. Click "**Apply**" to save the settings

About the Pulse I/O Card

Once installed (see [Installing FloSeries3 Cards](#)), the Pulse I/O card provides the input for connecting pulsing flow meter sensors and an output for connection to ancillary devices.

The input and output terminals available on each Pulse I/O card are shown in the diagram below.



NOTE: MACE recommends the user studies the relevant documentation supplied with each third party sensor prior to connection.



WARNING: The maximum XCi system current available for powering sensors attached to ALL installed cards is 1.25 Amps at 12VDC.



WARNING: The maximum input voltage on any terminal is 30VDC.

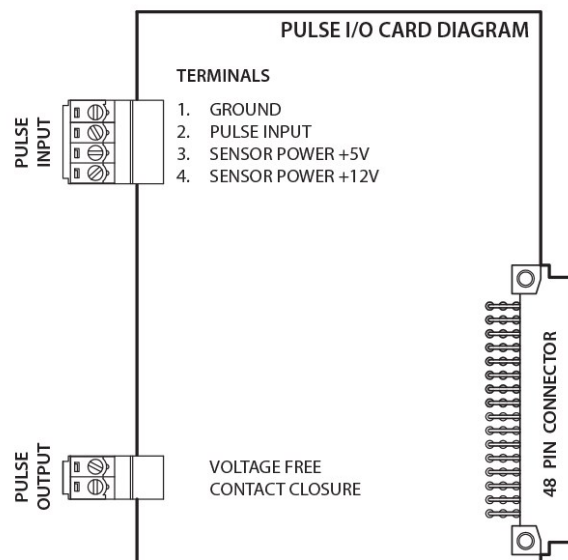

NOTE: Should insufficient I/O be available on a single Pulse I/O card another card (Part No. 850-353) should be purchased.

Connecting sensors to the Pulse I/O card

Wiring the Pulse input

Each Pulse I/O card provides one pulse input for connecting devices such as rate pulsing flow meters. The pulse input terminals available on each Pulse I/O card are shown in the diagram below.

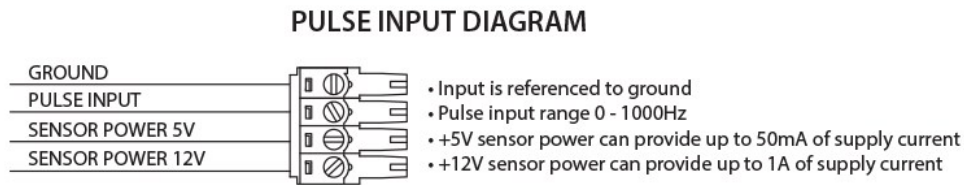

Cable length guidelines

- Wherever possible sensors should only be grounded at the XCi device end.
- Long pulse cable input runs require proper grounding and minimisation of ground loops.
- For sensors powered by +5V, cable lengths <10m are recommended.
- For sensors powered by +12V, cable lengths <100m are recommended.

Power guidelines

Because pulse rate sensors are often left running continuously, their power consumption is an important consideration.

- A continuously running sensor should have a current consumption **<10mA**.
- Sensors using **>10mA** require a larger solar panel (eg. 10 Watts).
- Sensors using **>50mA** should also have an external battery or mains power.



NOTE: Sensors connected to the Pulse I/O card can be configured to switch ON/OFF to save power rather than run continuously. See [Add a new "Flowrate \(using pulse\)" channel type](#)

After completing the wiring, configure the sensor using FloCom+ (see [Add a new "Flowrate \(using pulse\)" channel type](#))

Wiring the pulse output

Each Pulse I/O card provides one pulse output for connection to ancillary devices such as water samplers and or data loggers. The pulse output terminals available on each Pulse I/O card are shown in the diagram below.

PULSE OUTPUT DIAGRAM

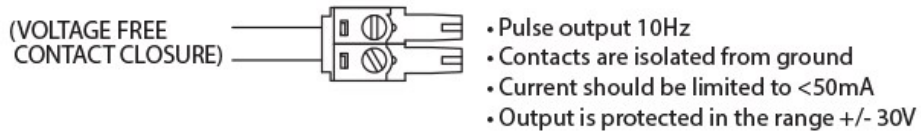

After completing the wiring, configure the output using FloCom+ (see "[Pulse](#)" - output type)

The SDI-12 Master Card

About the SDI-12 Master card

Once installed (see [Installing FloSeries3 Cards](#)), the SDI-12 Master card enables an array of SDI-12 environmental monitoring sensors to be controlled and logged by the XCi device. The input terminals available on each SDI-12 Master card are shown in the diagram below.

Once a sensor has been wired to the SDI-12 Master card it must be configured using FloCom+ software so that the XCi device can control and record data from the sensor (see [Add a new "SDI-12" input type](#)).

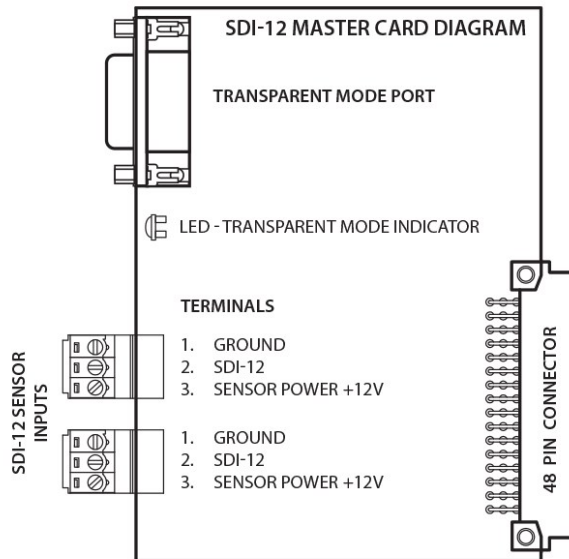

NOTE: MACE recommends the user studies the relevant documentation supplied with each third party sensor prior to connection.



NOTE: MACE recommends the user downloads and studies the SDI-12 protocol documentation available from <http://www.sdi-12.org>



NOTE: As per the SDI-12 protocol, each card can support up to 10 sensors. Should more inputs be required another card (Part No. 850-368) should be purchased.



WARNING: The maximum XCi system current available for powering sensors attached to ALL installed cards is 1.25 Amps at 12VDC.

Wiring an SDI-12 Master card

After installing the card, connect it to the SDI-12 sensor using either of the two 3-way terminal blocks. Two terminal blocks are provided for user convenience when wiring multiple sensors.

The “**Transparent Mode**” port allows you to send extended SDI-12 commands to sensors using a terminal program such as Microsoft® HyperTerminal®.

Connect the PC running the terminal program using a serial cable (or USB-to-serial adapter).

The port settings in the terminal program should be set to the following:

- 9600 baud
- 8 data bits
- No parity
- 1 stop bit
- No flow control



NOTE: When a transparent mode session is in progress the LED Transparent Mode Indicator will light.

HyperTerminal is a registered trademark of Microsoft Corporation in the United States and other countries.

Introduction to FloCom⁺

MACE FloCom⁺ is the software that enables you to communicate, configure and download data from your HydroMACE XCi device

System Requirements

Minimum system requirements for PC are:

- Windows® XP
- 10Mb available hard drive space
- USB port
- For many of the functions described in this manual FloCom⁺ Version 3.X.X.X



MACE Software End User License Agreement (EULA)

Users should read and accept the terms of the MACE EULA before installing FloCom⁺ on their PC. The EULA can be found on the downloads page of the [MACE website](#).

Installing FloCom+ Software

Download FloCom+ from our website www.macemeters.com

1. Run the “**FlocomPlus_[version number].exe**” file to start the installation process.
2. Follow the instructions on the welcome screen then click the “**Next**” button to move to the next screen.
3. Choose a location on your computer to install FloCom+. FloCom+ will setup a folder in your program files called “**MACE\MACE FlocomPlus**”. This is the default option. Click the “**Next**” button to continue.
4. Select an Installation Folder. “**MACE FloComPlus**” is the default.

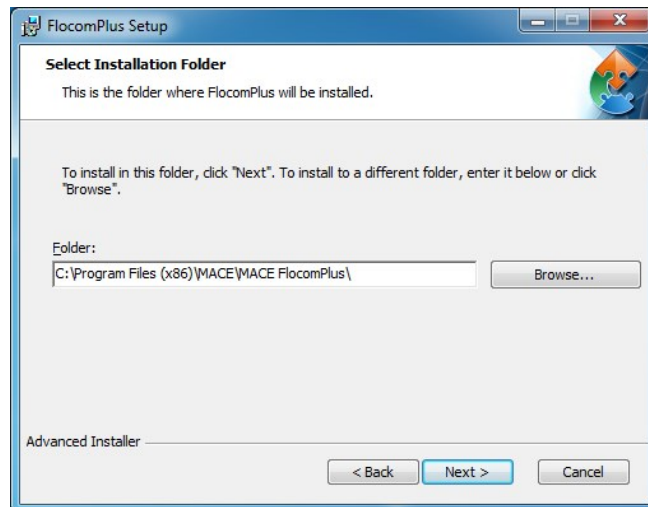

5. Starting installation. Click “**Next**” to begin installing FloCom+.
6. FloCom+ will now install. Once the software installation is complete click the “**Finish**” button to exit the setup program. FloCom+ is now ready to be used.
7. Run FloCom+ using the shortcut provided on your desktop. The startup menu will appear as shown

below. Click **"File>Comms settings..."** to configure FloCom+ for your computer.

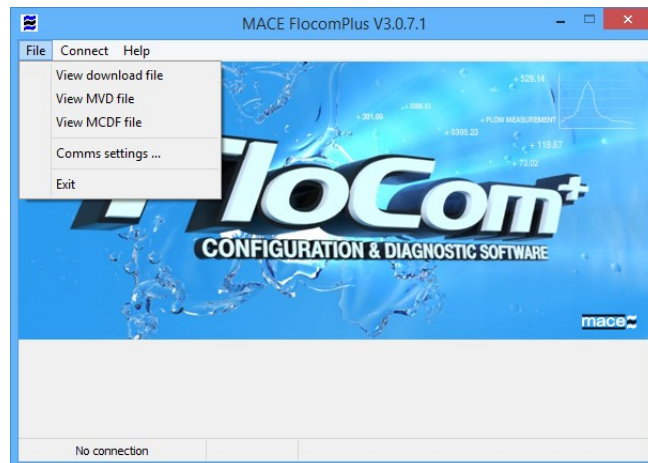

Windows XP:

[Download and install](#) the drivers for MACE FloSeries3 - USB external comms lead from www.macemeters.com prior to plugging the cable into a USB port.

Windows Vista/7 & Windows 8:



WARNING: After plugging the MACE comms lead into a USB port, Windows will search for the drivers and automatically download and install on your PC. A connection to the internet is recommended during this phase.



NOTE: If there are connection problems, check the "Troubleshooting" section, I can't "[Connect](#)" to my XCi with FloCom+

8. Check the **"Always use MACE cable if present"** box.

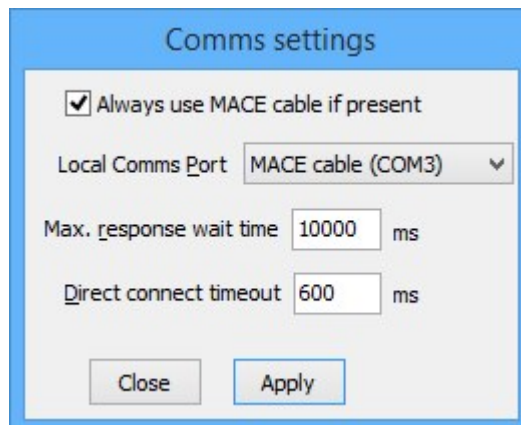

9. If you are not using a MACE USB Comms lead, select the “**Local Comms Port**” of your computer which will be used to communicate with the XCi device when a local connection will be made.



WARNING: If using a USB to Serial adapter please refer to the product documentation supplied with the adapter to ensure the correct driver is installed

10. Click “**Apply**” to save the settings.

Connecting to an HydroMACE XCi device

Connecting to the device using the communications port

1. Unscrew the cover from the communications port.
2. Connect a MACE USB Communication Cable (Part No. 850-363) between the USB port of the computer and the communications port of the HydroMACE XCi device located on the left underside of the enclosure.

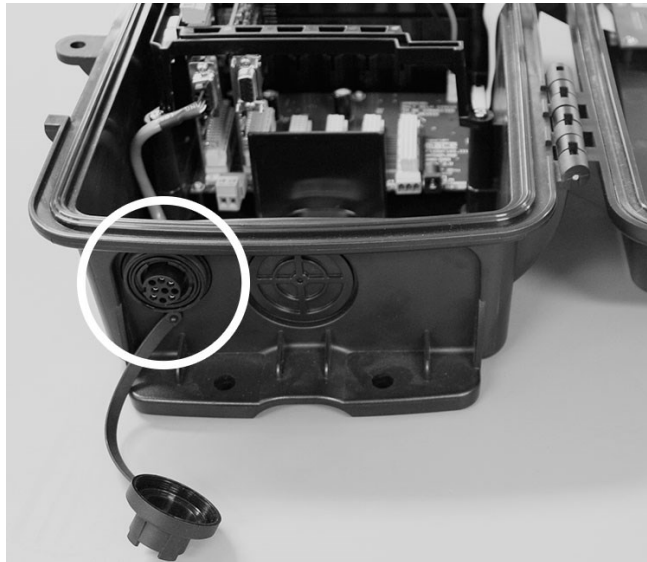

3. With FloCom⁺ running, click "**Connect to Flo3 device**" and the "**Connect to Device**" dialogue will open. Enter the password which has been set in the unit and select "**Continue**". (The default password is **superid**)
4. The main menu of FloCom⁺ that includes the device status summary screen is now visible as shown below.

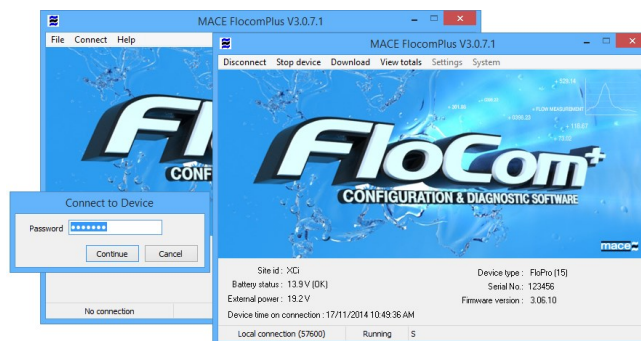

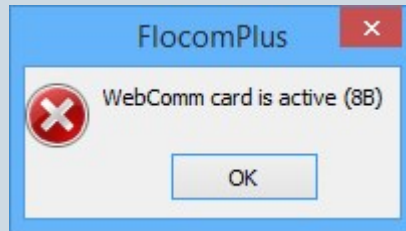

NOTE: If a WebComm card is installed and an upload session is active, you will **NOT** be able to "*Connect*" to the XCi device. In this case an error will occur until the WebComm session is inactive.



NOTE: The device must be configured and started before the instrument will measure and record data



NOTE: Once finished, remove the MACE comms cable and screw the comms port cover back in place to maintain environmental protection

Remote communications with an XCi device

When a MACE WebComm card is [installed and configured](#) in the HydroMACE XCi device a remote communications session may be initiated.

1. With FloCom⁺ running, click "**Connect>to remote site**" and the "**MACE Remote Access application**" will open.
2. For further details see [Remote communications with an XCi device](#)



NOTE: The XCi device **MUST** be configured and started via the local communications port **BEFORE** a remote comms session can be initiated.

What to do if the password is lost/forgotten

In the event that you have forgotten or lost your password, the following steps should be taken:

1. From the "**MACE FloCom Plus**" main screen, click "**Help>Show device authorisation code**".
2. Click "**Connect**" and the "**Connect to device**" dialogue box will appear.

3. In this dialogue box the device's unique authorisation code is seen at the bottom

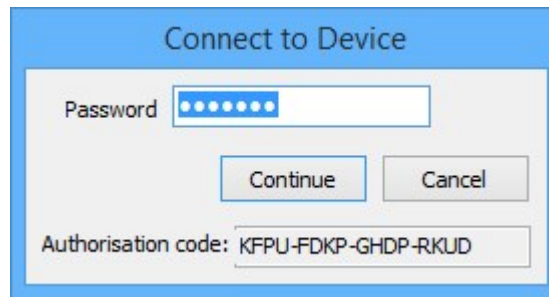

NOTE: You MUST note this code EXACTLY to fulfil the next steps

4. The unique device serial number located on an adhesive label inside the box should also be noted.
5. Once you have noted the code and serial number, you must contact your local MACE dealer/distributor and inform them of these details. They will obtain a "counter-code" for your device.
6. From the "**MACE FloCom Plus**" main screen, click "**Connect**" and the "**Connect to device**" dialogue box will appear.



NOTE: This "counter-code" has a time limit on its validity (typically three days). It must be used to access the unit within this time or it will be void and a new one will need to be produced

7. Enter the 16 character authorisation "counter-code" into the "**Password**" field and click "**continue**". You will now have super user access to the device.



NOTE: You should immediately change the super password to one that will not be forgotten (see [Change super password](#))

Remote communications with an XCi device

Getting ready for a “Remote Access” session

A remote access session utilizes the MACE Data Server (MDS) and the MACE WebComm card in the XCi device as a pass through to send/receive commands from FloCom⁺. In order to initiate a remote access session, you **must**:

- Be running Windows 7 or above
- Have an XCi device running firmware version 3.07.14 or above
- Have a WebComm card running firmware version 1.03.34 or above
- Have FloCom+ version 3.00.10 or above
- [Have a site set up on the MDS](#)



NOTE: To update to the required firmware version see [How to update XCi firmware](#)

Enable a “Remote Connection” in the WebComm card

After ensuring that the correct firmware versions are uploaded into the XCi device, the user must ensure that the WebComm card has been enabled for a “**Remote Connection**”.

1. Click on **Settings>Webcomm>**
2. Ensure that your WebComm card has been [configured correctly](#).
3. Check the “**Enable remote connection**” checkbox in the “**MACE Server**” details section

MACE Server

URL http:// data.macemeters.com

User name UserName

Upload key ●●●●●●●●

Enable Remote Connection

4. Click **Apply** then **Exit** to return to the “**Device Settings**” dialogue box.

Run a WebComm “Forced Upload”

To ensure that the MDS recognizes that a site is using firmware versions capable of a remote access session, you should first initiate a “forced upload” using the “[WebComm utility](#)”.

1. Click on **Settings>Webcomm utility>Start upload**
2. Ensure that an “**RHS: Connecting to server**” message is received from the MDS.

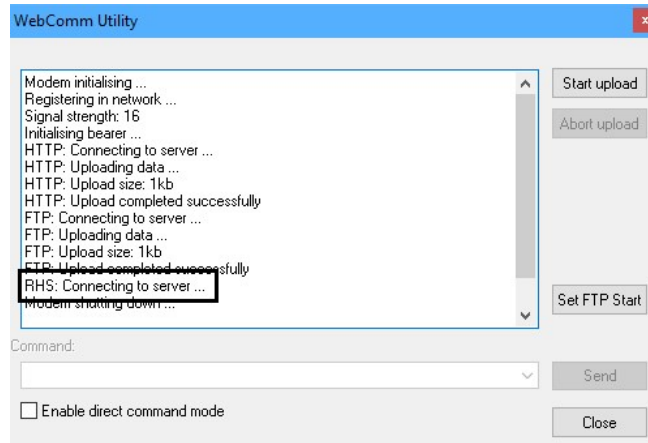

3. **Close** the **WebComm utility**
4. Make any necessary changes to the XCi device by **Edit settings**:
5. **Start** the device and **Disconnect**

Connect to an XCi device remotely



NOTE: A remote access session will only be available ONCE per upload period. That is, it will take the server nominally the time of one upload period to be able to initiate a remote access session. For example, if an XCi device is uploading to the MDS every hour, the user will need to “wait” for up to an hour in order to gain remote access.

1. In FloCom+ **Connect>to Remote site**

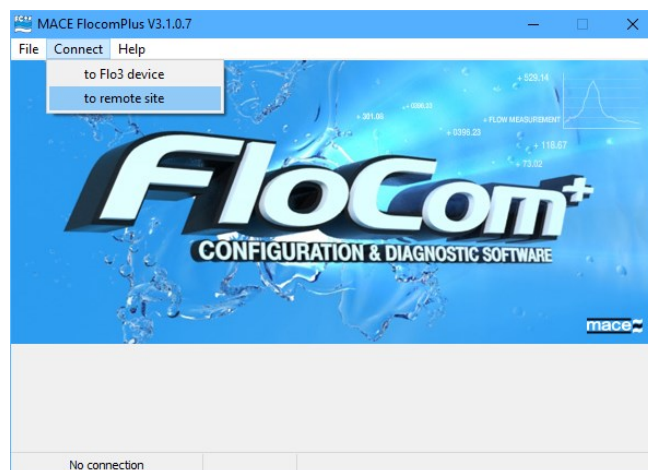

2. The **MACE Remote Access Utility (MRAU)** will start.
3. Enter your **MACE User Authentication** credentials.



NOTE: These are the credentials that you use to Login to view your MACE WebComm site data

MACE User Authentication

data.macemeters.com

User name
User@YourEmail.com

Password
••••••••

Remember password [Register](#)

OK Cancel

4. The MRAU will populate a list with the sites that can be accessed remotely

The **Next Wakeup** column tells the user how long it is until the WebComm card at the **Site name** is scheduled to send an upload. When remotely accessing the XCi device, the MRAU must “tell” the WebComm card to stay “awake” in order to initiate a remote access session.

Name	Description	Status	Next Wakeup
C46	CAIDD site with MSB Sensor and Standard 850-052	Disabled	20 min
Fresno	Fresno State Pump Site	Waiting	29 min
XCi Test	MAC Test Bench	Waiting	Less than 1 min

Search: Refresh

Name: Mathew Campbell Company: MACE

- Right-click on **the Site name** and **Request Remote Host Comms Session**. If you wish to be notified by SMS/Email click on **Request Remote Host Comms Session with Notifications**.

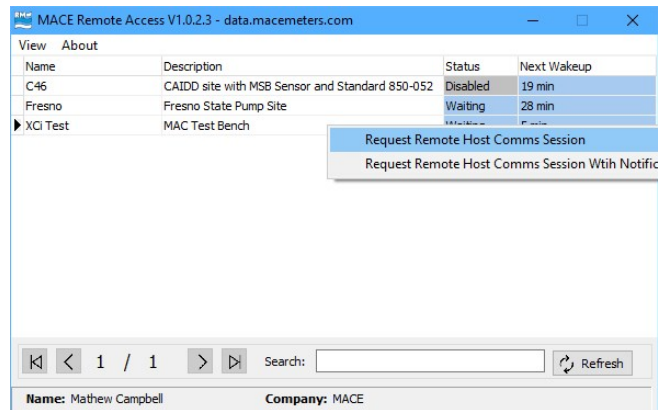

NOTE: You will only be notified by SMS/Email if you have enabled "[Alarms](#)" and have sufficient alarm credits.

- The **Status** will change to "**Requesting**" and the "**Next wakeup**" time will countdown. When the Remote access session can be used, the status will change to **Ready**

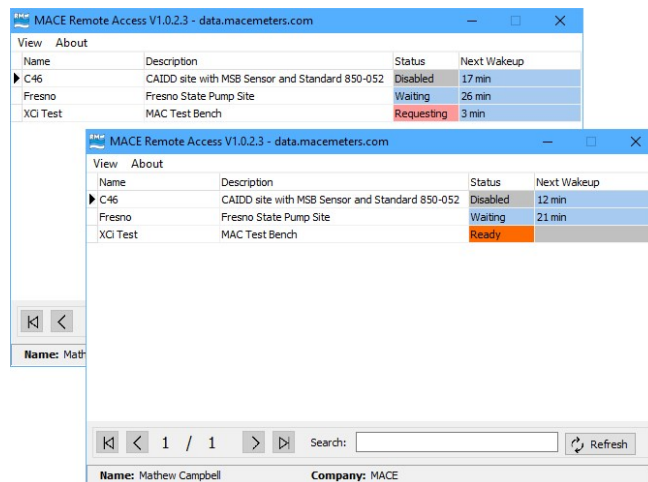

- Right-click on **the Site name** and **Request Enter Host Comms Session**.

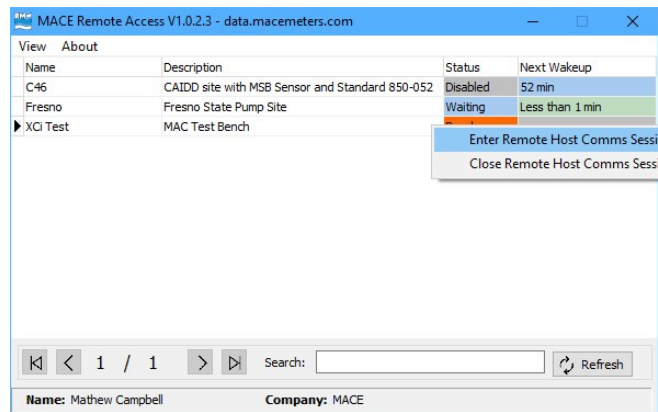

After a short period where the remote comms session is being connected to the device, FloCom+ will prompt for the XCi device password to be entered as usual.

- Since during a remote session, FloCom+ is talking to the XCi device via the MDS, there may be a noticeable lag between sending a command and receiving a response. In this case, FloCom+ will give the user an indication that communications are being established.

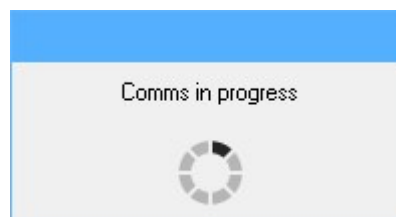

Normal communications can now be undertaken using FloCom+ as usual. The majority of functionality that can be accessed when using a local connection with FloCom+ may also be accessed during a remote session, however, certain functionality may be restricted. For example, making changes to certain Webcomm settings.



NOTE: Should the user (and therefore the connection) be inactive for 15 minutes, a warning will appear in the Windows Notification centre and on the screen of FloCom+. If no action is taken, the XCi device will be **Started** with it's last **Applied** settings and **Disconnected** from the MDS.

When the remote session is completed, simply **Start** the device and **Disconnect** from the unit. The MRAU will prompt for the session to also be closed with the MDS. If you answer **No**, the remote session will return to the **Ready** state.

Right click on the **Site name** to **Enter** a new session or **Close** the session

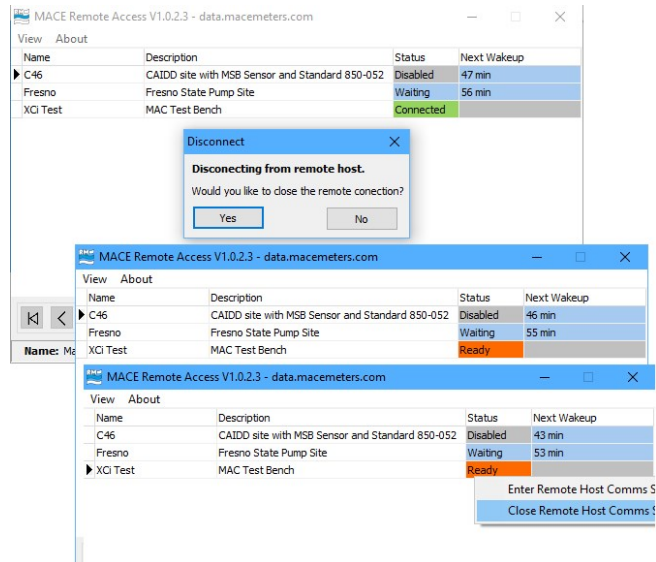

9. The host comms session will be closed and the FloCom+ main screen will be seen.

FloCom⁺ - The essential steps to configuring an HydroMACE XCi device

Before an HydroMACE XCi device can be used, it must be "configured" for operation. This entails a knowledge of the field application and what you wish to measure.

For example, if you wish to measure flow rate through a Parshall flume and totalise that flow, three parameters (known as "**Channels**" in an XCi), will need to be added and configured:

- **Depth channel** - The depth of the stream flow through the Parshall Flume must be measured
- **Flowrate (using weir) channel** - The flow rate of the stream is calculated from the measured depth by multiplying by the appropriate equation selected using FloCom⁺
- **Total channel** - The total is calculated by multiplying the flow rate, by a time period

With a knowledge of the application and what parameters need to be measured, the XCi device can be configured for use in a few simple steps. The procedure is structured in a logical sequence so that the device is configured in the correct order.

1. From the main menu click "**Settings**" and the "**Edit configuration settings**" dialogue box will appear as shown.

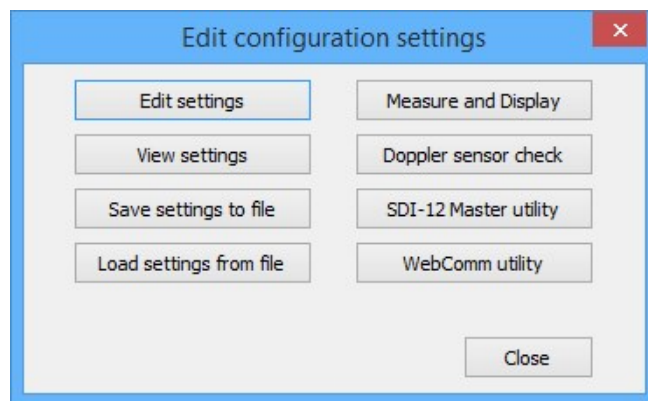

2. Click "**Edit settings**" and the main "**Device Settings**" dialogue box will appear.

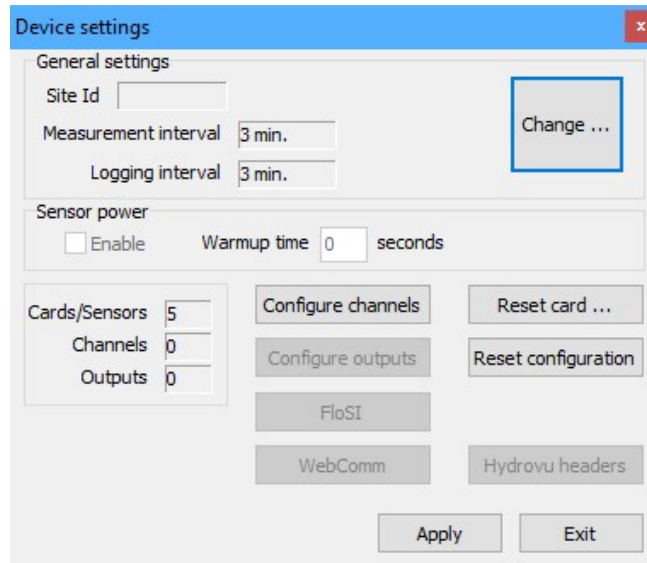

Edit general settings

1. The first step is to edit the "**General settings**".
2. From the main "**Device Settings**" dialogue box click "**Change**" and the "**General Settings**" dialogue box will appear as shown.

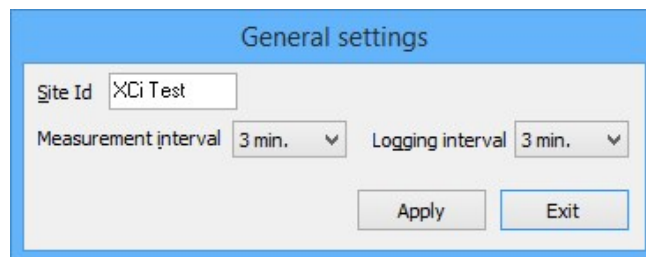

3. Type in a "**Site ID**"

Site ID

The "**Site Id**" is a text field used to identify the location of the device. When data is retrieved from the device, it will be identified by this name. For example, the "**Site Id**" might be the name of the treatment plant or license number.



NOTE: The instrument's "**Site Id**" is required before the configuration can be applied successfully

4. Select a "**Measurement interval**" and a "**Logging interval**" from the drop-down list boxes.

Measurement and Logging interval

The measurement interval is the time at which the device 'wakes up' to measure/calculate the values on each of the configured channels. Data is logged in the data file ONLY at the logging interval. The measurement interval will always be shorter than or equal to the logging interval. In the case of the measurement interval being shorter than the logging interval, then the data logged will be the average of those values calculated per measurement interval.



NOTE: The measuring and logging intervals available, are affected by other settings in the XCi configuration: eg. integration time and sensor power. The XCi will always warn the user of the implication of changing a setting that impinges on these intervals.



NOTE: The logging interval can only be a multiple of the measuring interval.

5. Click "**Apply**" and the main "**Device Settings**" dialogue box will re-appear.

Sensor power

When enabled (via the check box), this function instructs the device to switch the 12VDC power line **ON** for sensors wired to I/O card/s. A warmup time must be set by the user, suitable for the sensor/s application. For example, a 4-20mA output downward looking ultrasonic depth sensor may require a 25 second warm up prior to recording a stable depth reading.



NOTE: In the case where multiple sensors are powered by the 12VDC switched power, the warmup time should be set according to the sensor that requires the longest warmup.

Sensor power



Enable

Warmup time

seconds



NOTE: This check box will be greyed out, if no cards that support switched power are installed in the XCi device



WARNING: The maximum system current available for powering sensors attached to ALL I/O cards is 1.25 Amps at 12VDC

Add XCi channels

As described in the introduction to this chapter, a knowledge of the field application and what you wish to measure is essential to the successful configuration of the HydroMACE XCi device

1. From the main "**Device Settings**" dialogue box click "**Configure channels**" and the "**Configure channels**" dialogue box will open.

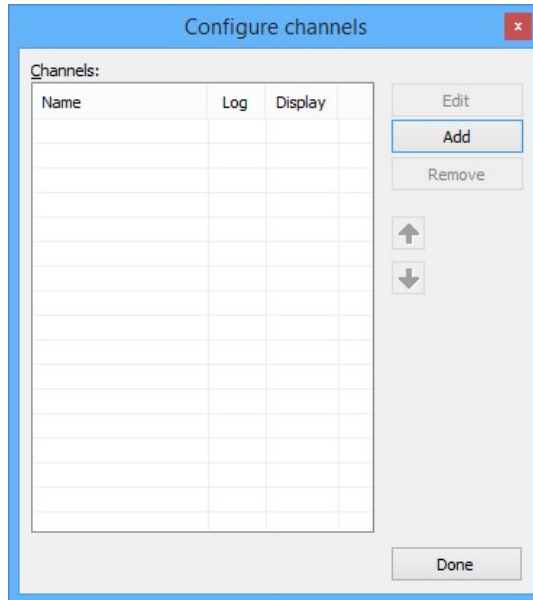

2. Click "**Add**" and the "**New channel**" dialog box will open to allow the selection of a "**Channel type**" to add.

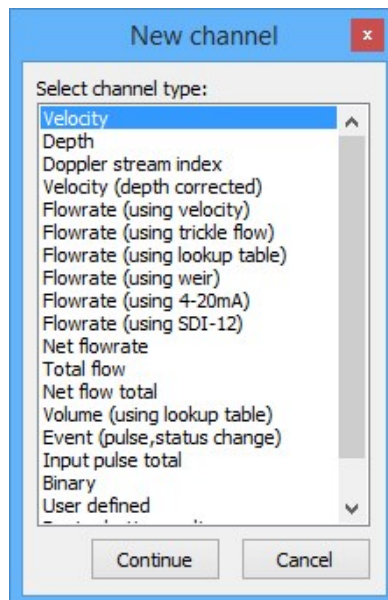



NOTE: The “*Channel types*” visible in the “*New channel*” dialogue box are dependent upon the cards that have been installed in the HydroMACE XCi device.

3. Select the “*Channel type*” that is required and click “*Continue*”. The “*Channel name*” dialogue box will appear. Enter a channel “*Name*” in to the text field (16 character maximum). This “name” will also be displayed on the HydroMACE XCi device main LCD if enabled. Click “*Continue*”.
4. In the “*New channel - Select card*” dialogue box that appears, select the FloSeries3 card (and physical input, see [Xci Input Types](#)) from which the named channel will receive its value.



WARNING: Each MACE card available is referenced in the list by its type and slot number. (eg. Doppler card @ 1). ALWAYS ensure that the appropriate card in the correct slot is selected. This is particularly the case when multiple cards of the same type are inserted in the HydroMACE XCi device.

5. Click “*Continue*” to complete the new channel. The “*Configure channels*” dialogue box will re-appear with the new channel listed.

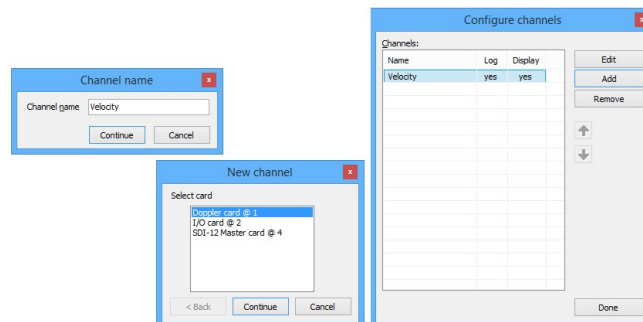

NOTE: As a particular card’s input becomes fully utilised the card will not appear on the “*Select card*” list.

Edit XCi Channels

Once the required channels have been added, they must then be edited to ensure that the measured values are meaningful.



WARNING: All configured channels MUST be edited prior to starting the XCi device. Editing the channel/s enables the correct configuration information to be sent to the controller module.

1. From the main "**Device Settings**" dialogue box click "**Configure channel**" and the "**Configure channels**" dialogue box will appear.
2. Highlight the channel you wish to edit and click "**Edit**". A channel specific "**Edit channel**" dialogue box will appear.
3. Edit the settings in the "**Edit channel**" dialogue box to suit your application as per the recommendations in [XCi Channel Types](#). In all cases, the "**Edit Channel**" dialogue box provides information of:
 - "**Channel path**" - This describes the channel type and the card input source.
 - "**Channel name**" - This is the name given to the channel by the user when [added to the configuration](#).
 - "**Decimal places**" - The user can set the number of decimal places (0, 1, 2, 3) using the drop down list box. Data can be logged with these decimals in the data file and displayed on the LCD.

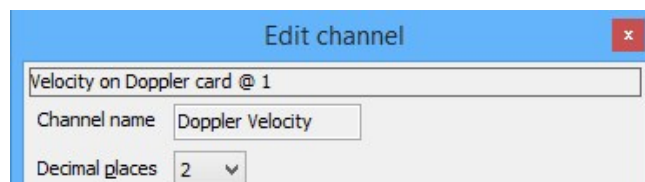

4. Click "**Apply**" to save the settings and return to the "**Configure channels**" dialogue box.

Ordering, renaming, setting of attributes and removing channels

Ordering configured channels

The channel list after “**Channels**” have been added reflects the order in which they were configured and in which the XCi device takes physical measurements. This also orders the channels in both the logged data and the LCD. For example, when scrolling through the displayed channels on the LCD, the output order will be the same as the “**Configure channels**” dialogue box.

This order can be changed to suit the users needs

1. Highlight the “**Channel**” in the list you wish to move and click either the “**up**” or “**down**” arrows (where available).



NOTE: The order is hierarchical and certain limitations apply. A “**Channel**” that is dependent on the value of one or more channels cannot be moved higher in the list than the lowest “**Channel**” upon which it depends.

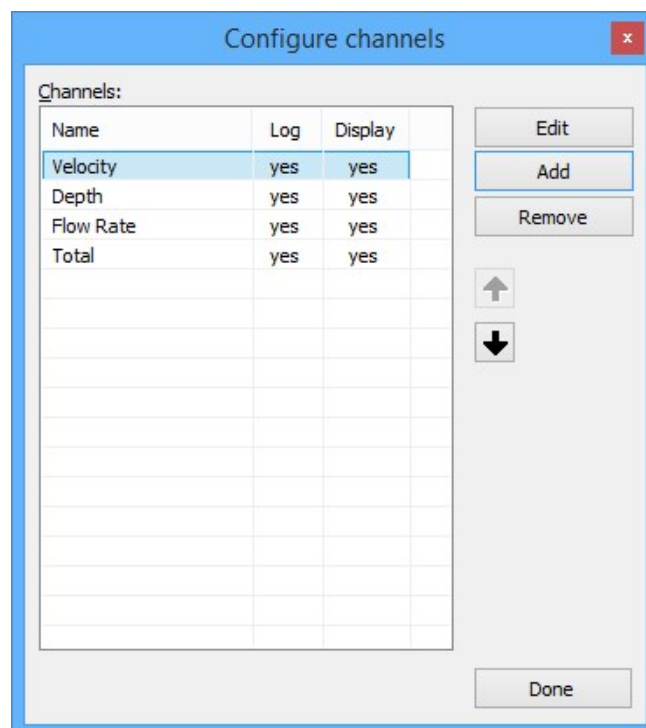

Renaming configured channels

The channel names that have been given during the “**Add channel**” procedure can be changed at any time afterwards.

1. Simply highlight the channel name that is to be changed, then right-click. Select “**Rename channel**” and the “**Channel name**” dialogue box will appear, in which the channel name can be edited.

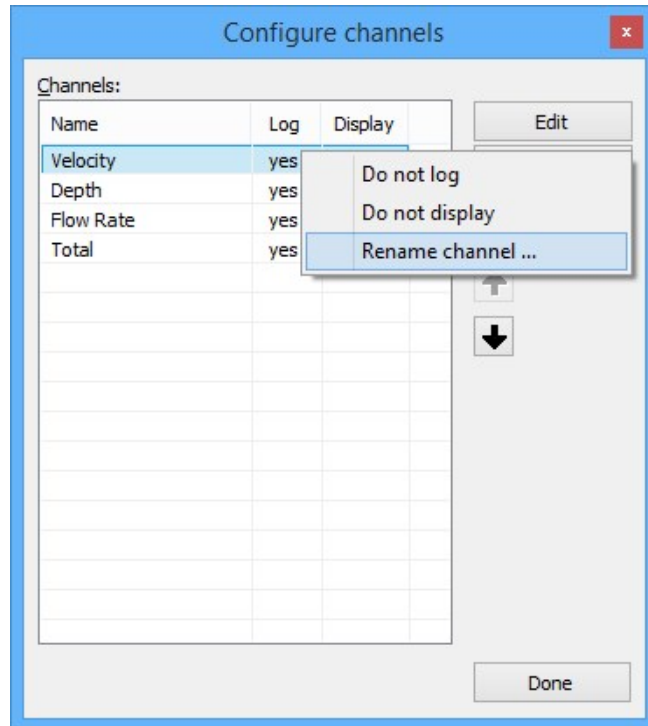

NOTE: A channel name can only occur once in a configuration. If a channel is given the same name as an existing channel, FloCom+ will give an error message



WARNING:

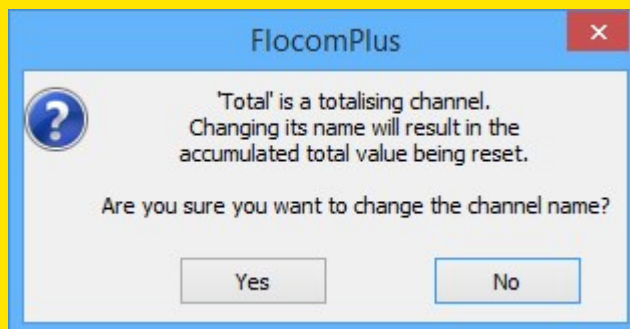

Renaming a Total "*Channel Type*", will necessitate the totaliser being reset. FloCom+ will give a message to warn of this behaviour.

Setting logging and display attributes for channels

Under certain circumstances, it may be desirable to log only the values from certain channels of an XCi configuration. For example, when logging a flow rate and accumulated total that is calculated from a velocity and a depth measurement in a partially-full pipe, the user may decide that only the flow rate and totaliser channels will be logged.

1. Simply highlight the channel name that is to have the logging attribute set to "**yes**" or "**no**", right-click on the highlighted channel and select "**Do not log**" or "**Log channel**". Once the attribute has been set, it will appear in the "**Configure channels**" dialogue box.

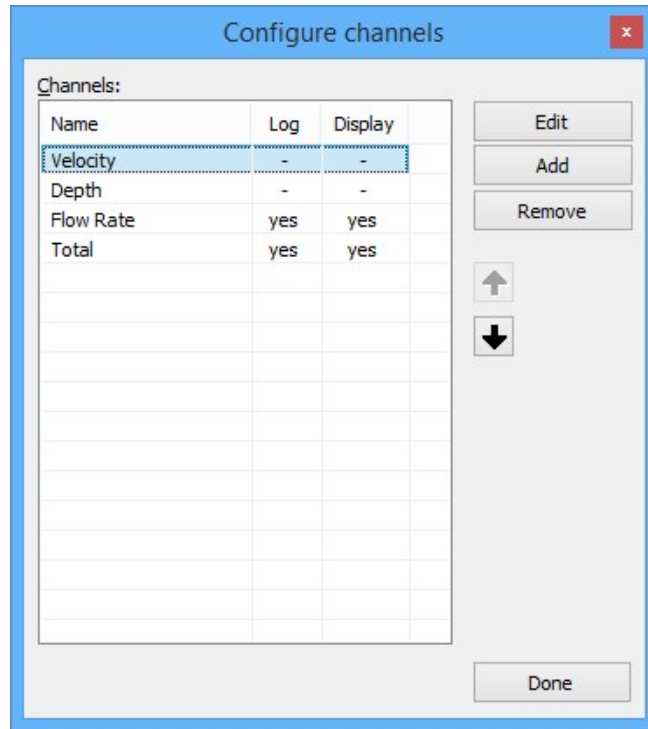

Under certain circumstances, it may be desirable to display only the values from certain channels of an XCi configuration on the external LCD. For example, when a flow rate and accumulated total that is calculated from a velocity and a depth measurement in a partially-full pipe is calculated, the user may decide that only the flow rate and totaliser channels will be displayed.

1. Simply highlight the channel name that is to have the display attribute set to **"yes"** or **"no"**, right-click on the highlighted channel and select **"Do not display"** or **"Display channel"**. Once the attribute is set, it will appear in the **"Configure channels"** dialogue box.

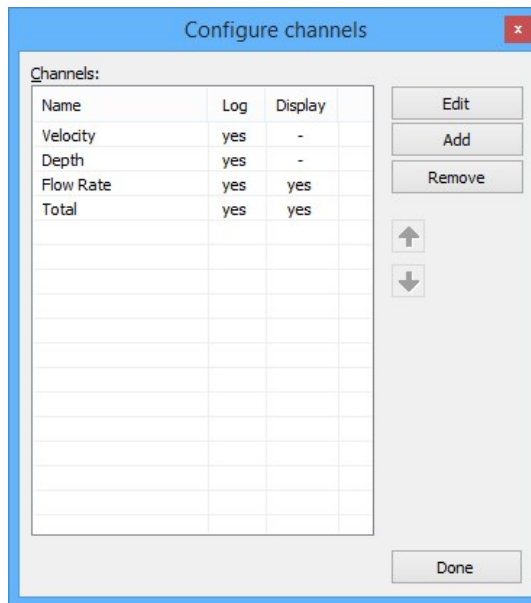

Removing configured channels

1. Highlight the "Channel" in the list you wish to remove and click "Remove".



NOTE: The removal is hierarchical and certain limitations apply. A **"Channel"** that is referenced by at least one other **"Channel"** cannot be removed unless the dependent **"Channel"** is also removed first.

2. If dependent channels also require removal, accept the change by clicking **"Remove"**.

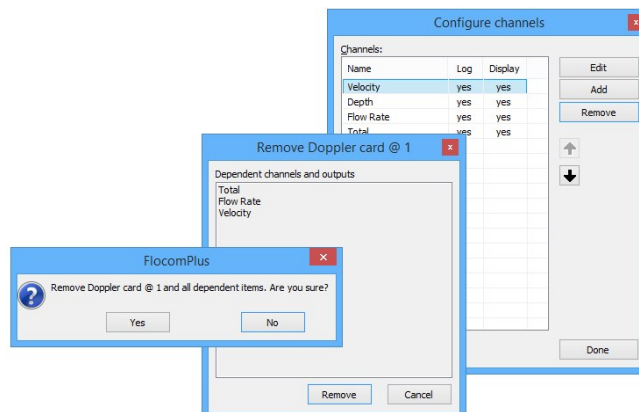

Reset card/configuration

Reset card

This function enables the user to remove a configured card and all its associated channels.

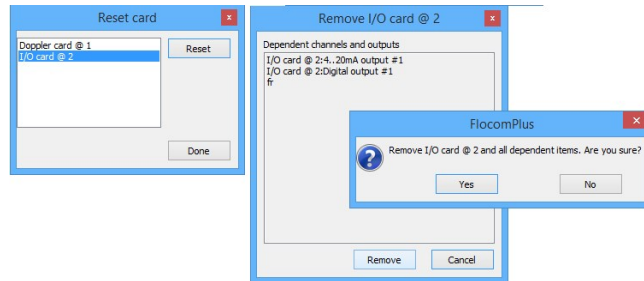

WARNING: Use "Reset card" with care

Reset configuration

Clicking "**Reset configuration**" causes all configured modules, channels and outputs to be removed.

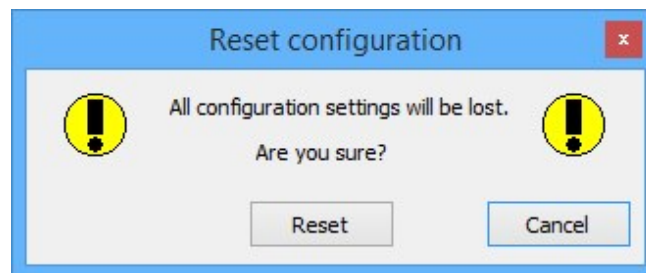

WARNING: Use "Reset configuration" with care

The File menu

These functions are accessed via the "**File**" menu from the "FloCom+ **Home screen**" and then selecting the related option.



NOTE: The "**File**" menu is only available when not connected to the HydroMACE XCi device

[View download file](#)

[View MDCF file](#)

[Comms settings](#)

View download file



NOTE: MACE Download files are saved as CSV files

Opening a file

On entry, an open file prompt window is displayed. If downloaded data was saved during the current session, the last downloaded data file appears as the default selection. On selecting “**Open**” the selected file is loaded and if successful the data is displayed as a text file. A different downloaded data file may be selected at any time by selecting the local “**File**” function and repeating the file selection procedure.

Viewing a file

Time stamp tree view

This pane enables the user to quickly navigate the data file by date and time. Expand the tree on the date of interest to reveal the various time stamps. Click the time stamp you wish to view and the data file will automatically scroll to it.

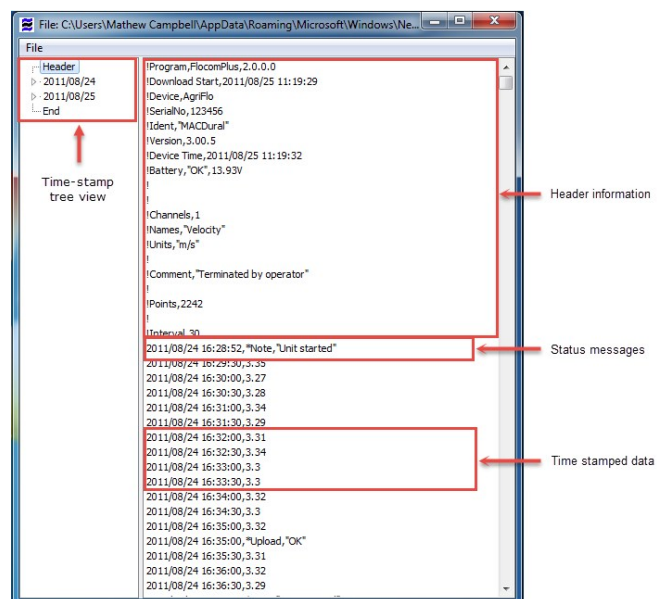

Header information

At the top of each data file the following information is displayed:

- Version of FloCom⁺ used to download the file;
- Time and date the data was downloaded to the PC;
- Device type; HydroMACE XCi device;
- Serial number of the XCi device;

- Version of firmware installed in the XCi device;
- Time and date of the clock in the XCi device;
- Battery status and charge (voltage) of the XCi device;
- Number of channels being recorded;
- The names of each channel being recorded;
- The units of measure used for each channel being recorded;
- 'Points' refers to the number of data lines in the downloaded file;
- 'Interval' refers to the time in seconds between each time stamp (logging interval).

Status messages

Status messages are defined by the use of an asterisk (*) immediately following a time stamp. For example, in the download image above the following message appears which tells the user the date and time the unit was started.

2011/08/24 16:28:52, *Note, "Unit started"

Table of Status messages

Status message	Description
Unit Started	Device was started
Unit stopped	Device was stopped
No external power	No external power was detected. If a solar panel is used this will occur at sunset
External power restored	External power is detected. If a solar panel is used this will occur at sunrise.
Low Battery	Time at which battery voltage fell below 11.5V
Battery normal	Time at which battery voltage exceeded 11.5V
Flat battery condition	Battery voltage at download time is less than 10V
Battery was flat	Battery was less than 10V
Sensor error	Any configured module not detected
Device reset #0*	Power up reset occurred. Generally occurs when the battery has been changed without first " Stopping " the unit
Device reset #1*	Clock reset. Generally occurs if a command line error occurs when talking to the Real-time clock (RTC).

Status message	Description
Device reset #2*	May occur between "Low battery" and "Flat battery" under certain conditions.
TOD clock error*	Error reading time-of-day clock
Pulse event	A pulse from a pulse event channel has occurred
Status change	The value on a status event channel has changed
Upload "HTTP OK"	A successful HTTP upload was made to the MACE data server
Upload "FTP OK"	A successful FTP upload was made to an FTP data server
Upload timeout	An unsuccessful upload attempt was made
Upload bearer error	The WebComm card was unable to establish a bearer connection and an unsuccessful upload attempt was made
Terminated by operator	The download was aborted by the user
Incompatible session/s skipped	The download includes only data since the last channel re-structure



NOTE: * - These messages are NOT symptomatic of a unit failure. Rather, they are a sign that the XCi has dealt with a potential problem internally.



NOTE: For further "WebComm" related status messages, see [Error messages table](#):

Time stamped data

At each time stamp the date, time and recorded channel values are shown. The date and time are followed by the recorded values for each of the configured channels. In the popup above, the configured channel is "**Velocity**" and it's time-stamped values include:

2011/08/24 16:32:00, 3.31

2011/08/24 16:32:30, 3.34

2011/08/24 16:33:00, 3.3

2011/08/24 16:33:30, 3.3

End of file

The end of the data file is always delineated by a "**Download End**" followed by the date and time.

View MDCF file



NOTE: MDCF Files - MACE Data Configuration File

The "**Select configuration file**" prompt window is displayed. If MDCF file/s were saved during the current session, the last saved MDCF file appears as the default selection.

On selecting "**Open**" the selected file is loaded and the MDCF file is displayed showing a tree view of all configured cards and their respective sensors and measured channels.. A different MDCF file may be selected at any time by selecting the local **New file**" function and repeating the file selection procedure.

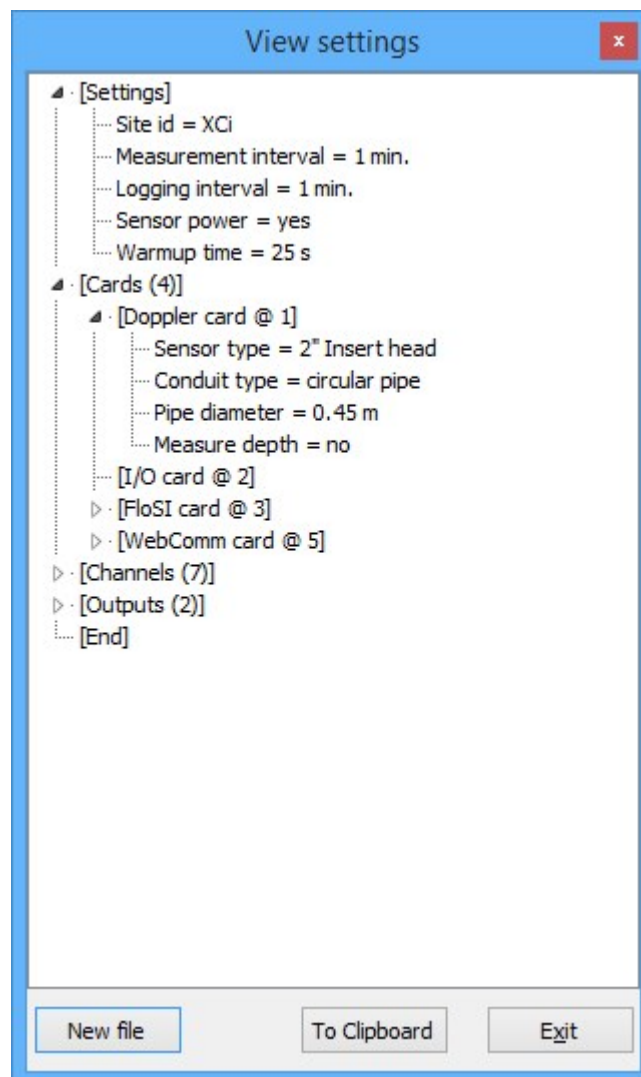

Comms settings

The "**Comms settings**" dialogue box will open

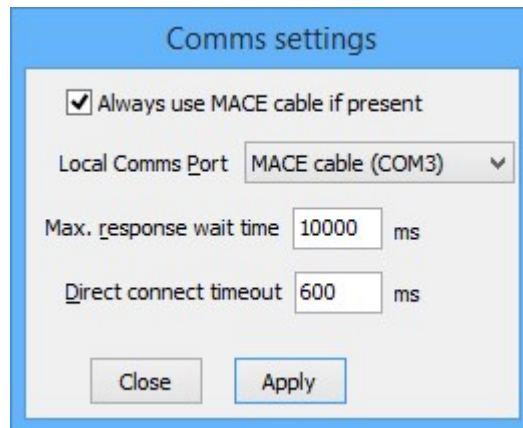

NOTE: MACE recommends using a MACE USB Communications cable (Part No: 850-363) for ease of use

1. Check the "**Always use MACE cable if present**" box and FloCom+ will automatically find and use the appropriate settings.
2. Click "**Apply**" to return to the FloCom+ "**Home screen**" where the "**Connect**" menu item is located.

See [Installing FloCom+ Software](#) and [Connecting to an HydroMACE XCi device](#) for further details



WARNING: If using a USB to Serial adapter please refer to the product documentation supplied with the adapter to ensure the correct driver is installed

The Main Menu

Upon "**Connecting**" successfully to the HydroMACE XCi device the "**Main menu**" will display as shown.



The system area of the "**Main menu**" contains information about the XCi device that is connected:

Site id:

The "**Site Id**" is a text field used to identify the location of the device.

Battery status:

Provides a value in V(olts) of the main battery when connected to the device.

External power:

Provides a value in V(olts) of the external power source when connected to the device.

Device time on connection:

The date and time on the XCi device real-time clock when the connection with FloCom+ was made.

Device type:

The XCi device type; AgriFlo, FloPro, HydroMace or HVFlo.

Serial No:

The internal electronic serial number of the device

Firmware version:

The firmware version (operating software version) of the XCi device controller card.

Disconnect

From the main menu click "**Disconnect**" and you will be asked "**Are you sure?**". Click "**Yes**" and the HydroMACE XCi device will be disconnected and you will be returned the start up menu. Click on "**File>Exit**" to shut down FloCom⁺

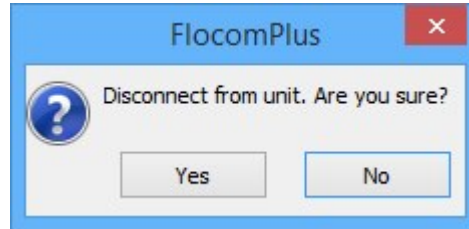

WARNING: If FloCom⁺ is not disconnected from the HydroMACE XCi device excess current will be drawn from the main battery.



NOTE: It is highly recommended that once the XCi has been "**Started**" and FloCom⁺ has been "**Disconnected**", that you [press the button](#) on the front of the enclosure to ensure that the LCD does NOT read "**Stopped**". You should also "[force](#)" a measurement to check the system operation.

Download

From the main menu, click “**Download**” to initiate the stored data download procedure. A save file dialogue box will appear.

The default file name is the unit ID. The default target directory is the directory into which the previous download file was stored.

Click “**Save**” once you are ready to download the device. The “**Download**” dialogue box will appear which shows the amount of stored data in the device and the date of the earliest available record. If the download end time is left unchanged or set to a time earlier than the earliest record, all stored records will be downloaded. Otherwise, only those data stored after the chosen “**Download from**” date will be downloaded.

Click “**Start download**” to complete the download procedure.

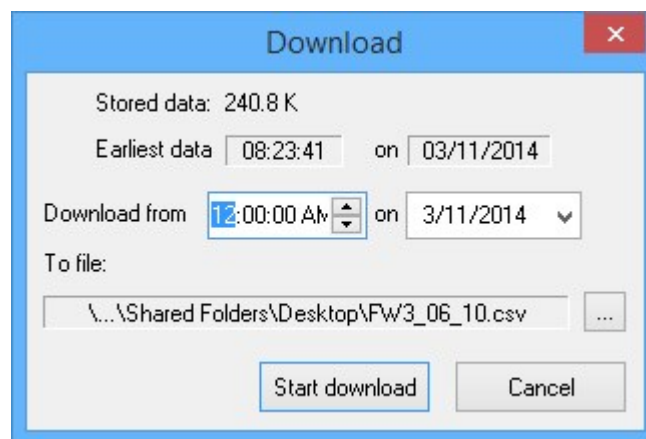

WARNING: Adding a new channel creates a new data session. It is essential to download the data from the XCi device **PRIOR** to adding new channels to an HydroMACE XCi device that has already been configured and has had data recorded.

For further information about the downloaded data file [View download file](#)

Settings

From the main menu click “**Settings**” and the “**Edit configuration settings**” dialogue box will appear as shown.

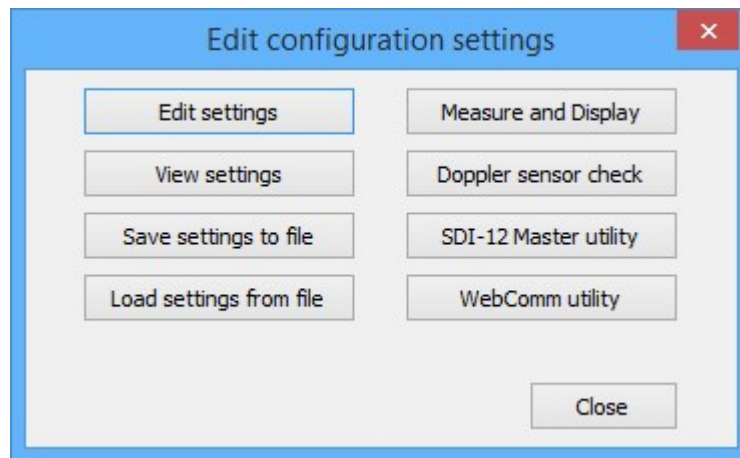

NOTE: Menu items may be "greyed out" depending upon the FloSeries3 cards physically installed.

Edit settings

Click “**Edit settings**” and the main “**Device Settings**” dialogue box will appear. The procedure for configuring an XCi device is structured in a logical sequence so that the device is configured in the correct order.



WARNING: For further details see [FloCom+ - The essential steps to configuring an HydroMACE XCi device](#)

View settings

By clicking “**View settings**” from the “**Edit configuration settings**” dialogue box the user is able to see a tree view of all configured cards and their respective sensors and measured channels.

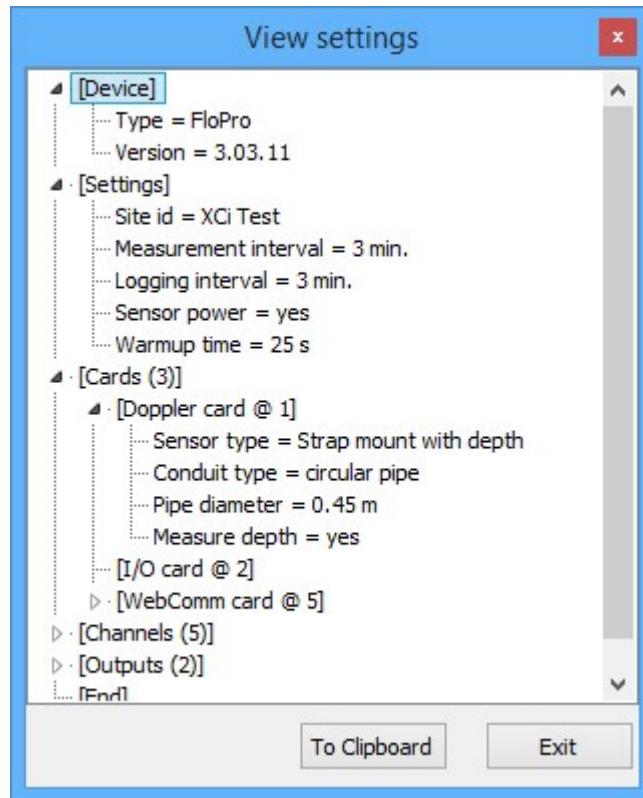

By clicking "**To Clipboard**" the user can then paste the tree view into any text document.



NOTE: There is no tree view available until at least one channel is configured.

Save settings to file

Clicking "**Save settings to file**" from the "**Edit configuration settings**" dialogue box allows the user to save a MACE Data Configuration File (MDCF) for later viewing and/or loading into another XCi device.

Load settings from file

A previously saved MDCF file can be loaded into an HydroMACE XCi device by clicking on "**Load settings from file**". The "**Select configuration file**" prompt window is displayed. If an MDCF file was saved during the current session, the last saved MDCF file appears as the default selection. After selecting the required configuration file, click "**Open**" and the file will be loaded into the HydroMACE XCi device.



NOTE: If a configuration file for an HydroMACE XCi device contains cards that are not available, or in different slot numbers than the XCi device into which you are trying to load the file, then the loading procedure will attempt to "*Cleanup*" the configuration. The following steps may be necessary:

1. From the "*Load configuration*" dialogue, note any "*Configuration discrepancies*" and assess whether or not they are to be expected. If not, a particular card may need to be re-installed (see [Installing FloSeries3 Cards](#))

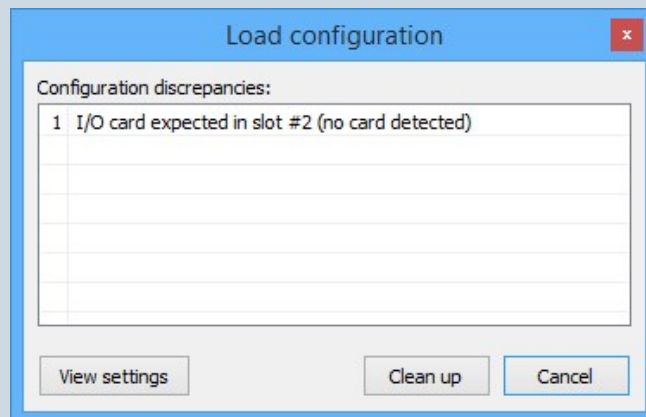

2. Click on "*Cleanup*" and the "*Missing cards*" dialogue will ask whether you wish to remove the missing cards. After verification, click "*Remove*"

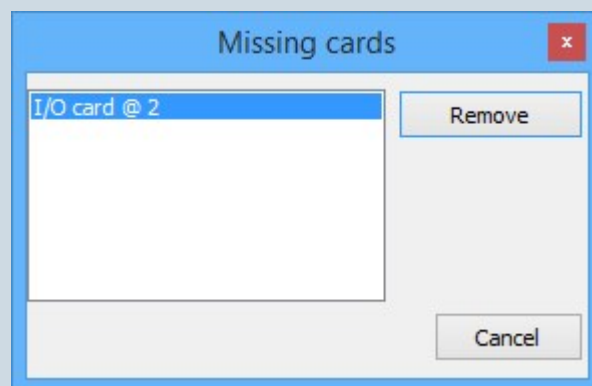

3. Any "*Dependent channels and outputs*" will be listed. After verification, click "*Remove*" again and you will be asked "*Are you sure?*"

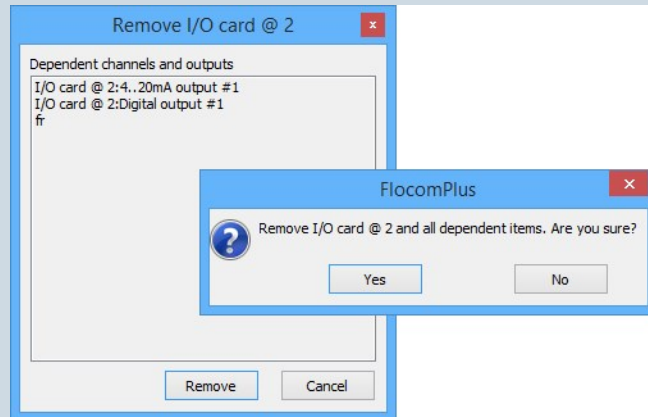

4. Send the "*Device configuration*" and update the unit.

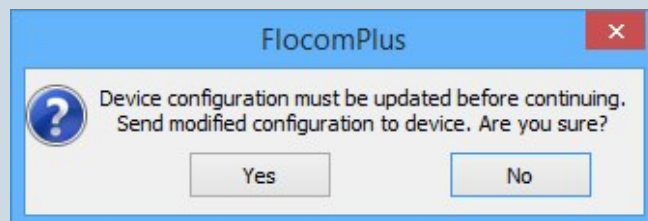

WARNING:

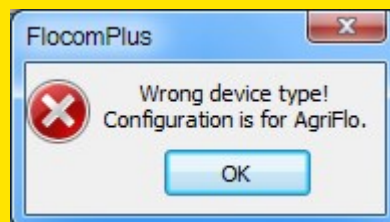

MDCF files can **ONLY** be loaded into XCi devices of the same type. For example, a file from a FloPro XCi **CANNOT** be loaded into an AgriFlo XCi and *vice versa*. A warning will be displayed

Measure and display

The "*Measure and Display*" function provides a quick utility to check that all connected and configured sensors and calculated channels are reporting "expected values". These are the data as they would be logged by the XCi device.



NOTE: This utility should be run every time a unit is configured or re-configured to ensure that the XCi device is correctly setup for the monitoring application.



NOTE: Total channels are not updated in the "*Measure and Display*" mode.

Click "*Measure and display*" then "**Start**" to observe the current channel values. Click "**Stop**" then "**Close**" to return to the main menu.

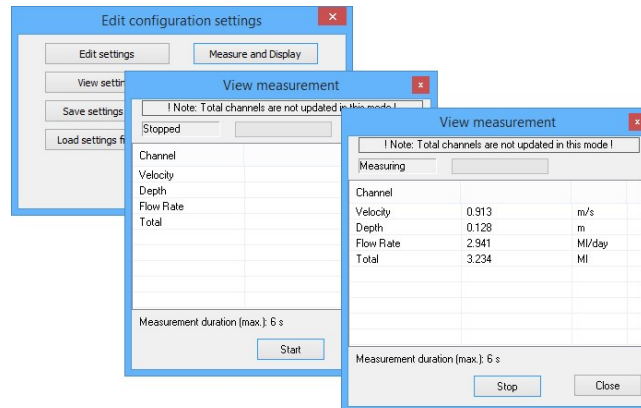

NOTE: See "*Measure and Display*" function for further details

SDI-12 Master utility

When enabled, provides the ability to control SDI-12 sensors prior to deployment. For full details see [The "SDI-12 Master Utility"](#)

WebComm utility

When enabled, provides a utility to communicate directly with the WebComm card prior to deployment. For full details see [The "WebComm Utility"](#)

Start/Stop HydroMACE XCi device

Once the HydroMACE XCi device has been configured and tested it is ready to be started so that measuring and logging is initiated.



WARNING: If the device is NOT started measurements will NOT occur

From the main menu click **“Start device”** and you will be asked **“Are you sure?”**. Click **“Yes”** and the device will start and you will be returned to the main menu. You will notice that the **“Start Device”** has changed to **“Stop device”** in the main menu.

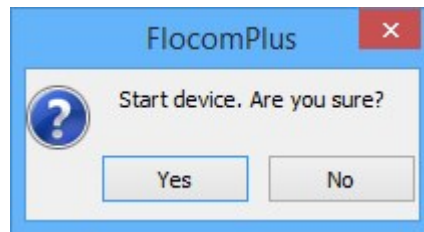

NOTE: It is highly recommended that once the XCi has been "Started" and FloCom+ has been "Disconnected", that you [press the button](#) on the front of the enclosure to ensure that the LCD does NOT read "Stopped". You should also [force](#) a measurement to check the system operation.



NOTE: To enable changing of settings, access of real-time data and resetting totals, the HydroMACE XCi device must first be stopped.

From the main menu click **“Stop device”** and you will be asked **“Are you sure?”**. Click **“Yes”** and the XCi device will stop and you will be returned to the main menu. You will notice that the **“Stop Device”** has changed to **“Start device”** in the main menu.

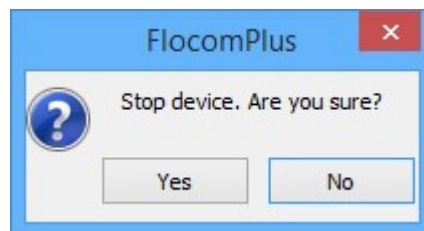

The System menu

From the FloCom+ Main Menu, click "**System**" and the following menu options will appear as listed below:



Set device date/time:

The device date and time must be set correctly, so that data can be accurately matched to known time intervals.

- The date and time can be set by manual entry or by synchronizing with the computer time.
- The time is held in 24 hour time.
- Allowance can be made for daylight savings time.



NOTE: MACE recommends that the user does not use daylight savings time. Users should set to standard time zone at all times.

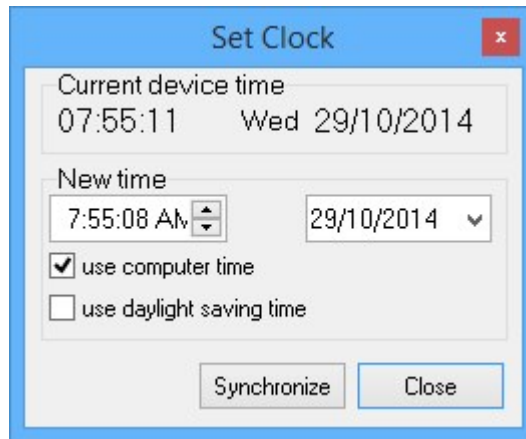

NOTE: MACE recommends that if the user has a WebComm card installed and the device time is needed to be set to an *earlier time*, "**Test an FTP Upload**" should be carried out before the time is reset.

Change download password

The download password allows low level access to the device. When this password is used for entry to the device, channel totals may be viewed and data can be downloaded.

Many irrigation districts give this password to irrigators to allow them to use the data for water management operations.



Change super password

The super password allows high level access to the device. When this password is used for entry to the device, all editing functions (including data downloading) are allowed.

Most irrigation districts set this password to prevent non authorized access to the device.

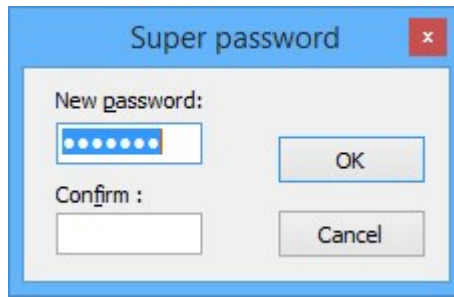

NOTE: Both the super and download passwords are case sensitive.

System settings

The system settings function allows the user to change the measurement units from metric to U.S and vice versa.

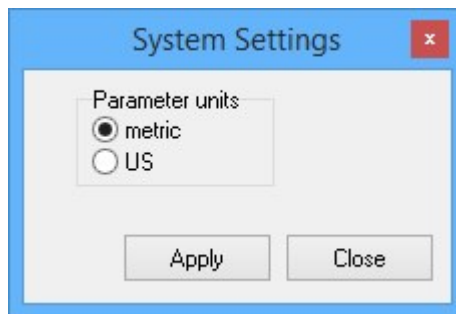

NOTE: For US units: "*Depth*" can be measured in "*ft or in*". Velocity is always measured in "*ft/s*".
For Metric units: "*Depth*" is always measured in "*metres*", and "*Velocity*" in "*m/s*".



NOTE: If the units system is changed the configuration will be reset to defaults

Clear stored data

This function should only be used by high level users. It clears all stored data from the device including all time stamped flow rate data.

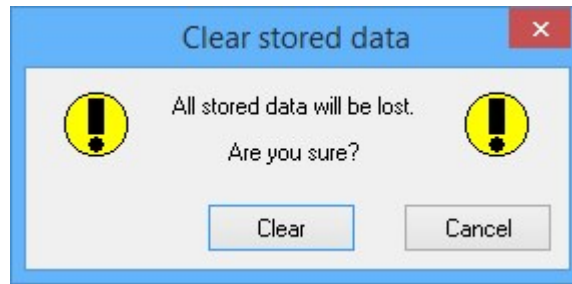

Card check

This function provides the user with a simple method of identifying the FloSeries3 cards that are currently installed in the device. It also includes the various card firmware versions and serial numbers. This information is important as functionality may be changed with later firmware releases.

A dialog box titled "Card check" with a red close button in the top right corner. It contains a table with four columns: Slot, Hardware type, Firmware version, and S/N. The table has five rows of data. Below the table are three buttons: "To Clipboard", "Refresh", and "Exit".

Slot	Hardware type	Firmware version	S/N
1	Doppler card	2.00.08	000014B25FAE
2	I/O card	1.02.04	000013D20E3D
3	SDI-12 Master card	1.01.07	00001408FC7A
5	WebComm SM card	1.02.20	000016BF22F3
	Display card	1.01.04	00000EEDAC0A

View totals

From the main menu click “**View totals**” and the “**Flow volume totals**” dialogue box will appear. This dialogue box lists all the accumulated flow channels and their respective totals and units.

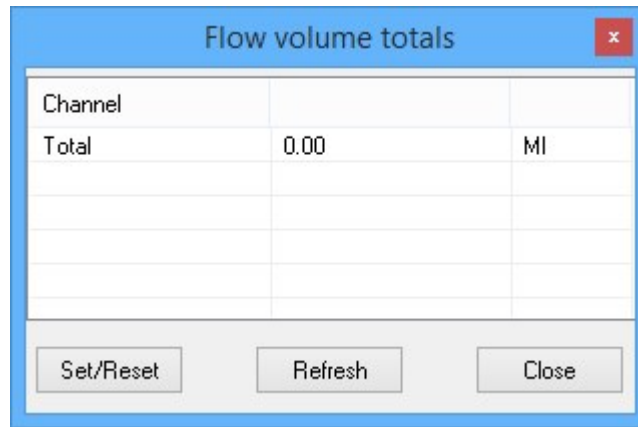

If the HydroMACE XCi device has not been started, the “**Set/Reset**” button will be active and the totalised reading can be changed.



NOTE: Only total channels that have been configured as Resettable can have their value reset



WARNING: It is strongly advised to download the logged data **PRIOR** to resetting the total value

1. Highlight the channel you wish to reset by clicking on it's name.
2. Click “**Set/Reset**” and the “**Set total value**” dialogue box will appear.

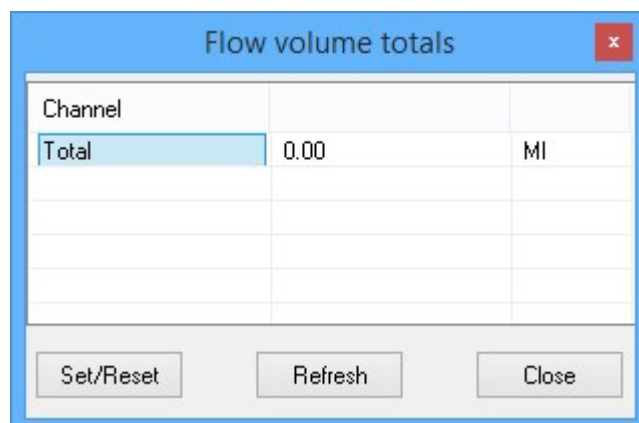

3. Enter the "**New value**" into the field and click "**Set value**". The new value will then be displayed in the "**Flow volume totals**" dialogue box.

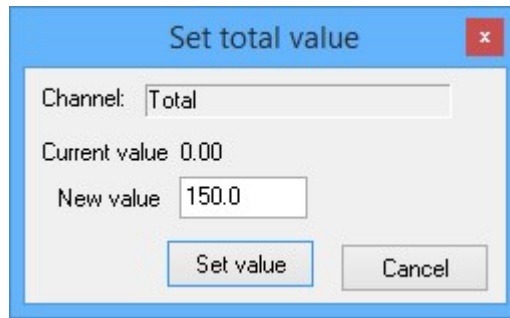

Set total value

Channel: Total

Current value 0.00

New value 150.0

Set value Cancel



WARNING: Double check that this value is CORRECT

4. If the HydroMACE XCi device has not been stopped, the "**Set/Reset**" button will be greyed out and the total/s will not be re-settable.
5. To update the reading whilst flow is accumulating, click "**Refresh**".

Introduction to XCi channel types

The MACE XCi system uses "**Channels**" to enable various measurements to be made and other parameters to be calculated (see [FloCom+ - The essential steps to configuring an HydroMACE XCi device](#)). These "**Channel types**" can be defined as:

Connected sensor channels -

These channels output their value based on information received from physically connected sensors wired to the various MACE FloSeries3 Cards.

Calculated channels -

These channels use the values received from "**Connected sensor channels**" and apply algorithms in order to output calculated values. For example, when calculating a flow rate in a partially full pipe a "**Flow rate (using velocity)**" channel type uses the values received from a connected velocity sensor and a connected depth sensor

System channels -

These channels have values directly received from the XCi system.

Full list of XCi channel types and brief description:

XCi Channel Types	Description
Velocity	This channel type MUST be used whenever the resultant velocity measurement will be used in a flow rate calculation. It MUST be used whenever a MACE Doppler ultrasonic sensor is used to measure velocity.
Depth	This channel type MUST be used whenever the resultant depth measurement will be used in a flow rate calculation. It MUST be used whenever a MACE Doppler ultrasonic sensor is used to measure depth.
Velocity (depth corrected)	Used to apply a correction factor to measured velocity data based upon different depth regimes of the stream.
Flowrate (using velocity)	Used to calculate a flow rate based upon the results obtained from configured velocity and depth channels.
Flowrate (using trickle flow)	This channel uses the Mannings formula to calculate flow rate in a circular pipe based upon depth measurement.

XCi Channel Types	Description
Flowrate (using lookup table)	Used to calculate a flow rate based upon a depth channel and a user configured lookup table of a rated structure.
Flowrate (using weir)	Used to calculate a flow rate based upon a depth channel and a selected weir type.
Flowrate (using pulse)	Used to calculate a flow rate based upon the number of pulses received by a Pulse I/O card during a measurement interval.
Flowrate (using 4-20mA)	Used to calculate a flow rate based upon a 4-20mA proportional current.
Flowrate (using SDI-12)	Used to calculate a flow rate based on an SDI-12 sensor flowrate value
Net flowrate	Used to calculate positive or negative flowrate based on the results obtained by addition or subtraction of two or more configured flow rate channels.
Total flow	Used to calculate an accumulated positive or negative total based on the results obtained from a configured flow rate channel.
Net flow total	Used to calculate an accumulated positive or negative total based on the results obtained by addition or subtraction of two or more configured flow rate channels.
Volume (using lookup table)	Used to calculate the volume of a storage (dam/tank) based upon a depth measurement and a user configured lookup table of the storage geometry.
Event (pulse, status change)	Used to record time stamp data based on pulse or status change events.
Input pulse total	Used to totalise pulses such as totalising flow meters and rain gauges.
Binary	Used to monitor switch closure events such as pump on/off status and/or rainfall gauges.
Channel level status	Switches a "Binary status" - output type based on a value being above or below a channel value.

XCI Channel Types	Description
Channel range status	Switches a " Binary status " - output type based on a value being within or outside a range of channel values.
User defined	Can be used when a 3rd party sensor with digital/analogue output is to be configured. It should NOT be used for velocity or depth sensors where the results are required for a flow rate calculation.
Device battery voltage	Used to monitor the XCI device internal battery voltage.
Device external voltage	Used to monitor the XCI device external voltage from a solar panel or mains charger.

Add a "Velocity" - channel type

This channel type MUST be used whenever a MACE Doppler ultrasonic sensor is used to measure velocity. This channel type MUST be used whenever the resultant velocity measurement will be used in a flow rate calculation.

Other 3rd party velocity sensors can also be interfaced to the XCi device. These sensors must be one of: [4-20mA](#), [Frequency Voltage](#), or [SDI-12](#) input type. Refer to their respective input "**Channel type**" topics.

Add a "Velocity" - channel type

This channel type MUST be used whenever a MACE Doppler ultrasonic sensor is used to measure velocity. This channel type MUST be used whenever the resultant velocity measurement will be used in a flow rate calculation.

Other 3rd party velocity sensors can also be interfaced to the XCi device. These sensors must be one of: [4-20mA](#), [Frequency Voltage](#), or [SDI-12](#) input type. Refer to their respective input "**Channel type**" topics.

"Depth" - channel type

This channel type MUST be used whenever the resultant depth measurement will be used in a flow rate calculation. .

So, what are "Slope" and "Offset"?

Most environmental sensors have a linear relationship between the measuring range and the electrical output range of the sensor.

For a depth sensor this relationship can easily be described using the well known equation of a straight line $Y = mX + B$

Where:

- **Y** = Depth
- **m** = Slope
- **X** = Sensor output
- **B** = Offset

Or in other words:

$$\text{Depth} = \text{Slope} \times (\text{Sensor output}) + \text{Offset}$$

Where:

- **Depth** = measured value
- **Slope** = Sensor measuring range / Span (difference between the sensor output at the top of the measured range and the sensor output at zero)
- **x** = Sensor raw value output
- **Offset** = - (Slope X Sensor output at zero)

For example, a typical ceramic depth sensor incorporated into the MACE Area/Velocity sensor, has a sensing range of 4 metres and a frequency output range of approx. 1.5 kHz to 14.5 kHz. Therefore:

- Sensor measuring range = 4 metres
- Sensor span = 14.5 kHz - 1.5 kHz = 13 kHz
- **Slope = 4/13 = 0.30769**
- **Offset = -(0.30769 X 1.5) = - 0.46154**
- The final equation - **Depth = 0.30769X - 0.46154**

Or, for a graphical representation of this equation:

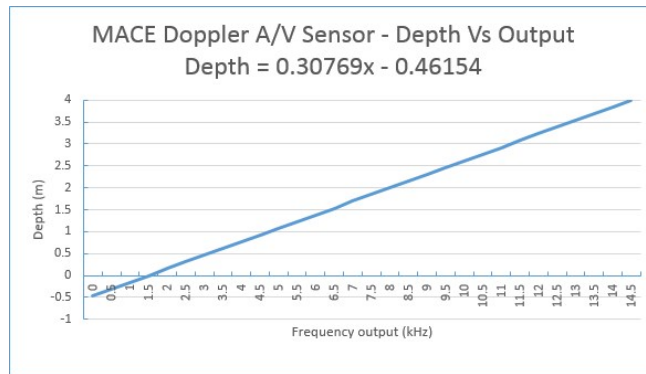

WARNING: Due to natural variability of the ceramic depth sensing diaphragm and associated electronics, these numbers are approximations and should not be used in configuring an XCi device. They are provided for illustrative purposes ONLY

"Depth" channel from a MACE EchoFlo Depth Sensor

The Slope and Offset values of the installed EchoFlo are dependent on the "**Fill Height**" as entered during the EchoCal configuration procedure.



NOTE: The following calculations are based on the EchoFlo being configured with a frequency output.

Manually calculating Slope

Slope = Fill Height ÷ Sensor Span

Fill Height: The maximum depth measured by the EchoFlo. Refer to the EchoFlo Quick Start Guide for further details.

Sensor Span: Is the difference between the sensor output at the top of the "**Fill Height**" (2000Hz) and the sensor output at the bottom (976Hz). The frequency output of an EchoFlo has a span of 1024Hz .

Manually calculating Offset

Offset = - (Slope x Sensor output at zero)

Metric example - you wish to calculate the slope and offset for an EchoFlo that has been configured with a "**Fill Height**" of 0.75m (75cm).

The following calculations will provide the sensor's slope and offset:

Slope

$$= 0.75 \div (2000-976)$$

$$= 0.75 \div 1024$$

$$= 0.00073$$

Offset

$$= - (0.00073 \times 976)$$

$$= - 0.71484$$

US example - you wish to calculate the slope and offset for an EchoFlo that has been configured with a "**Fill Height**" of 30".

The following calculations will provide the sensor's slope and offset:

Slope

$$= 30 \div (2000-976)$$

$$= 30 \div 1024$$

$$= 0.02929$$

Offset

$$= - (0.02929 \times 976)$$

$$= - 28.59375$$



NOTE: Be sure to record the relevant values for "*Slope*", "*Offset*", and depth units.

Edit a "Depth" - channel type

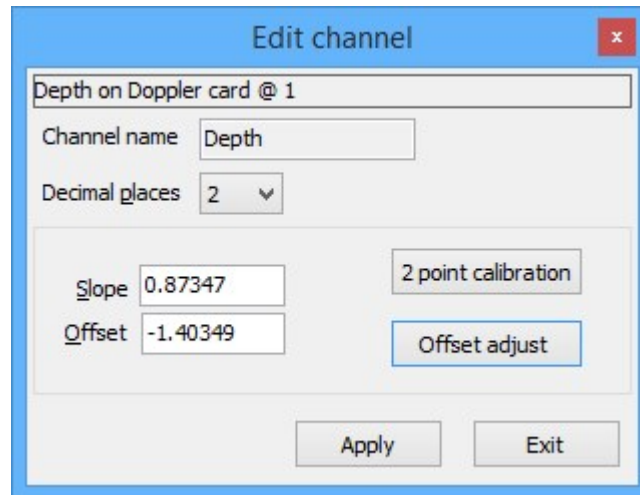

1. Enter the appropriate "**Slope**" and "**Offset**" values that are either supplied with the depth sensor or have been calculated.
2. Perform either an "**Offset adjust**" or "**2-point calibration**" to ensure accurate measuring results are recorded



NOTE: See either "**Offset adjust**" function or "**2-Point Calibration**" function for full details of these procedures.

3. Click "**Apply**" to save the settings and "**Exit**" to return to the "**Configure channels**" dialogue box.

"4-20mA input" - channel types

Add a new "4-20mA" input type

1. In the "**New channel**" dialogue box select the "**I/O Card**" from which the named channel will receive its value.

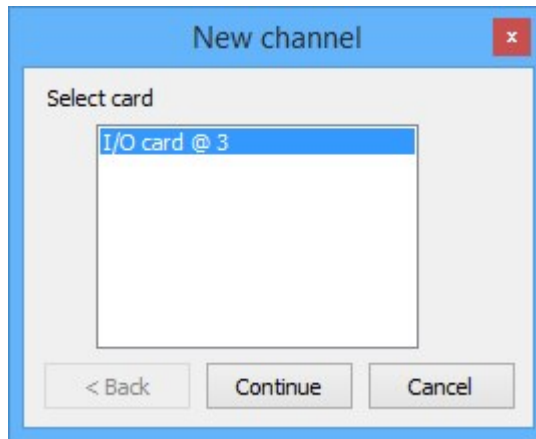

NOTE: As a particular "Cards" input/s becomes fully utilised the card will no longer appear on the "Select card" list.

2. Click "**Continue**" and a new dialogue box will appear with the available input types listed.

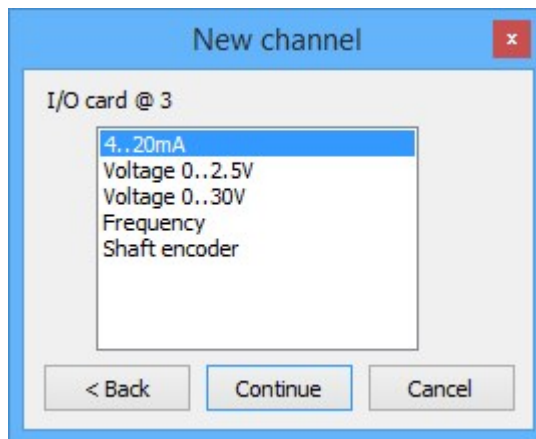

3. Select the "**4..20mA**" input type from the "**I/O Card @ Slot #**" list. Click "**Continue**" and then select the appropriate *physically wired input* from which the named channel will receive its value.

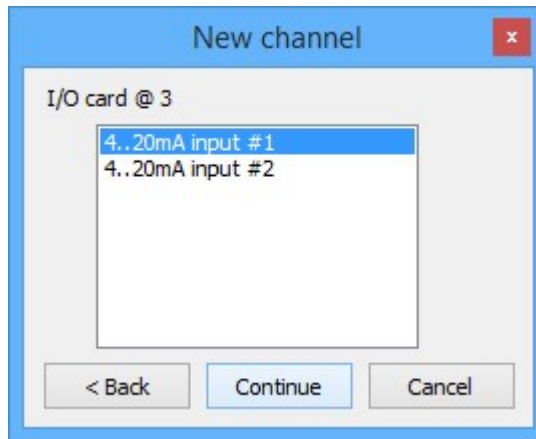

NOTE: As a particular cards inputs are utilised the input will no longer appear on the “*Input*” list.

4. Click “**Continue**” to complete the new channel. The “**Configure channels**” dialogue box will re-appear with the new channel listed.

Edit a "4-20mA" input type

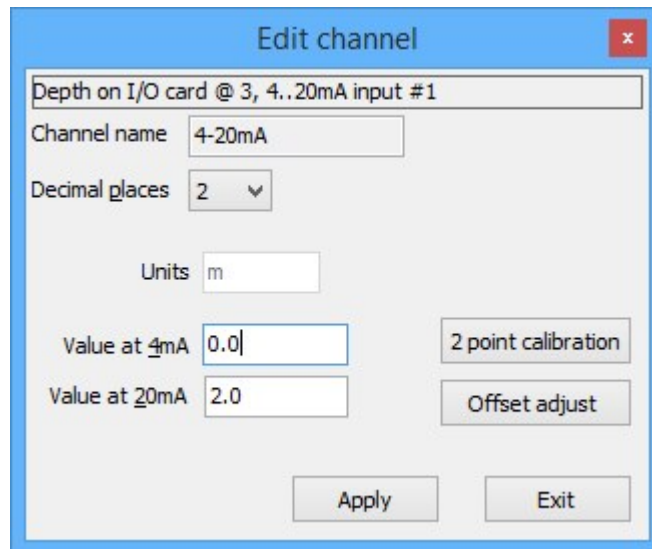

Units

This sets the units on the logged value. This is a text field and is user defined.



NOTE: If a “*Velocity*” or “*Depth*” channel type is configured on a “Card” input the measurement units are defined according to the “[System settings](#)”. If a “*Flowrate*” channel type is configured, a drop-down of both “*Units*” and “*Timebase*” will be provided.

Value at 4mA

Enter the value that corresponds to an input of 4mA

Value at 20mA

Enter the value that corresponds to an input of 20mA

Offset adjust

Perform an “**Offset adjust**” to fine tune the sensor readings. See “[Offset adjust](#)” function

2 point calibration

Perform a “**2 point calibration**” to span the sensor if the 4mA and 20mA values are either unknown or changed. See “[2-Point Calibration](#)” function

"Binary" - channel type

Add a new "Binary" channel type

1. In the "**New channel**" dialogue box select the "**I/O Card**" from which the named channel will receive its value.

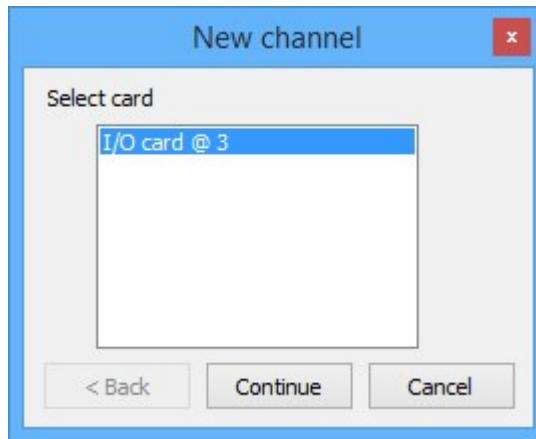

NOTE: As a particular "Cards" input/s becomes fully utilised the card will no longer appear on the "Select card" list.

2. Click "**Continue**" and a new dialogue box will appear with the available "**Digital inputs**" listed.

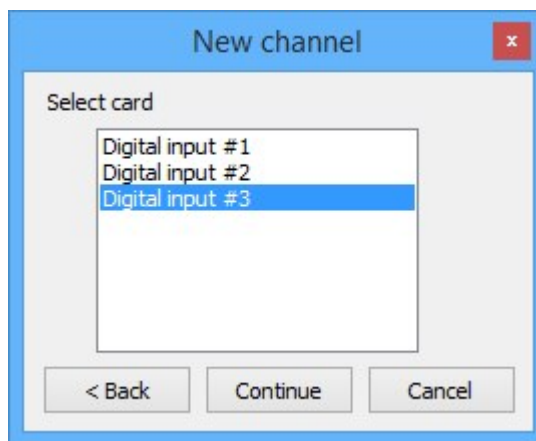

3. Select the appropriate *physically wired input* from which the named channel will receive its value.



NOTE: As a particular cards inputs are utilised the input will no longer appear on the "Input" list.

4. Click "**Continue**" to complete the new channel. The "**Configure channels**" dialogue box will re-appear with the new channel listed.

Edit a "Binary" channel type

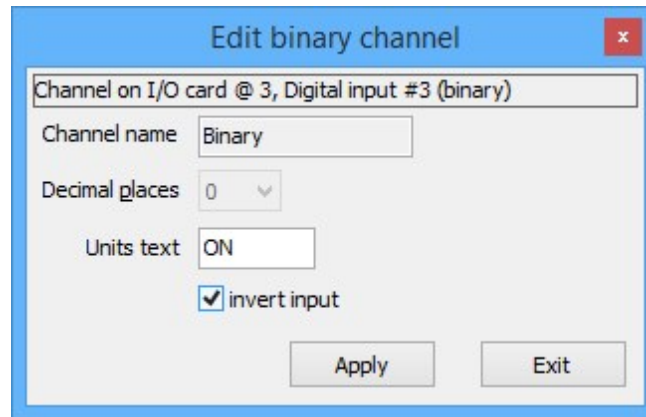

Channel on I/O card @ 3, Digital input #3 (binary)

Channel name: Binary

Decimal places: 0

Units text: ON

invert input

Apply Exit

Units text

This sets the units on the logged value. This is a text field and is user defined. In this example the "**Binary**" channel is being used to monitor the on/off condition of a pump. In the data the word "**ON**" will be logged whenever the pump is on.

Invert input

If this check box is ticked then the value will be inverted before it is logged.

"Frequency input" - channel types

Add a new "Frequency" input type

1. In the "**New channel**" dialogue box select the "**I/O Card**" from which the named channel will receive its value.

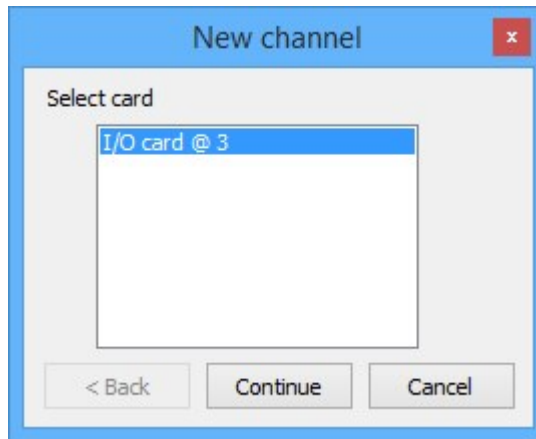

NOTE: As a particular "Cards" input/s becomes fully utilised the card will no longer appear on the "Select card" list.

2. Click "**Continue**" and a new dialogue box will appear with the available input types listed.

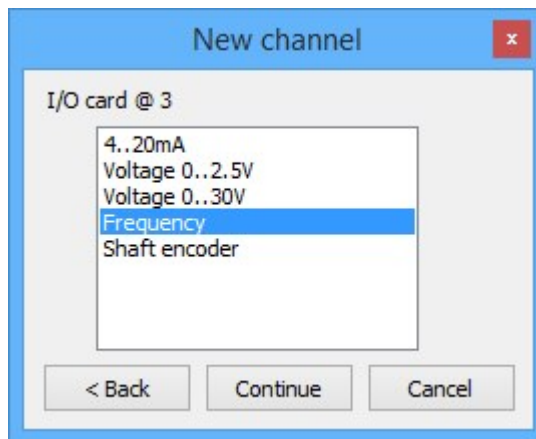

3. Select the "**Frequency**" input type from the "**I/O Card @ Slot #**" list. Click "**Continue**" and then select the appropriate *physically wired input* from which the named channel will receive its value.

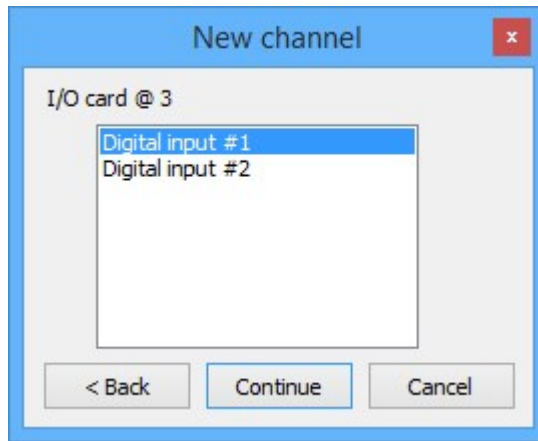

NOTE: As a particular cards inputs are utilised the input will no longer appear on the “*Input*” list.

4. Click “**Continue**” to complete the new channel. The “**Configure channels**” dialogue box will re-appear with the new channel listed.

Edit a "Frequency" input type

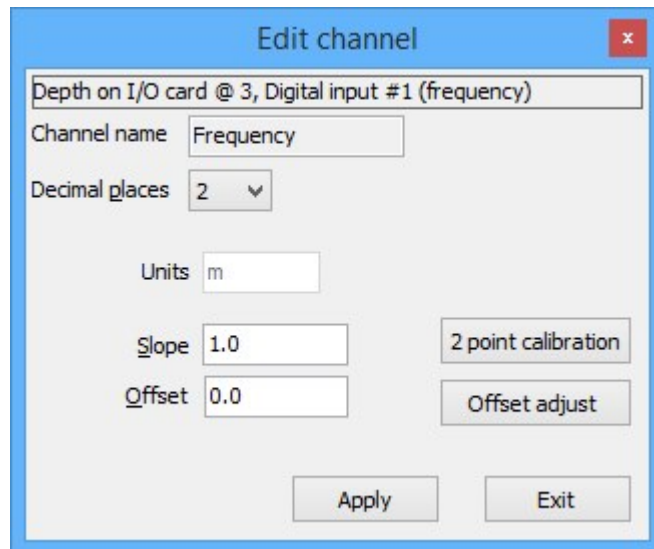

Units

This sets the units on the logged value. This is a text field and is user defined.



NOTE: If a “*Velocity*” or “*Depth*” channel type is configured on a “Card” input the measurement units are defined according to the “[System settings](#)”. If a “*Flowrate*” channel type is configured, a drop-down of both “*Units*” and “*Timebase*” will be provided.

Slope and Offset

See [So, what are "Slope" and "Offset"?](#)

Offset adjust

Perform an “**Offset adjust**” to fine tune the sensor readings. See ["Offset adjust" function](#)

2 point calibration

Perform a “**2 point calibration**” to span the sensor if the “**Slope**” and “**Offset**” values are either unknown or changed. See ["2-Point Calibration" function](#)

"Voltage input" - channel types

Add a new "Voltage" input type

1. In the "**New channel**" dialogue box select the "**I/O Card**" from which the named channel will receive its value.

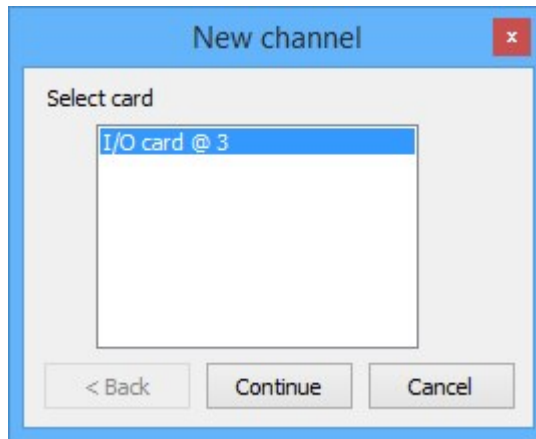

NOTE: As a particular "Cards" input/s becomes fully utilised the card will no longer appear on the "Select card" list.

2. Click "**Continue**" and a new dialogue box will appear with the available input types listed.

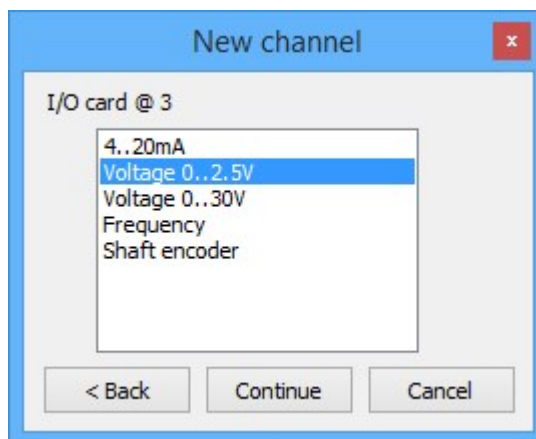

3. Select the "**Voltage**" input (range) required from the "**I/O Card @ Slot #**" list. Click "**Continue**" and then select the appropriate *physically wired input* from which the named channel will receive its value.

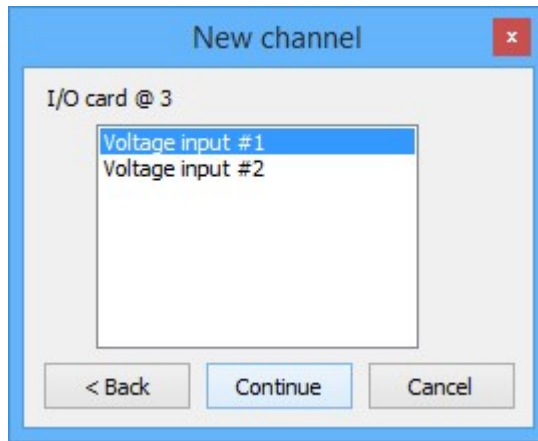

NOTE: As a particular cards inputs are utilised the input will no longer appear on the “*Input*” list.

4. Click “**Continue**” to complete the new channel. The “**Configure channels**” dialogue box will re-appear with the new channel listed.

Edit a "Voltage" input type

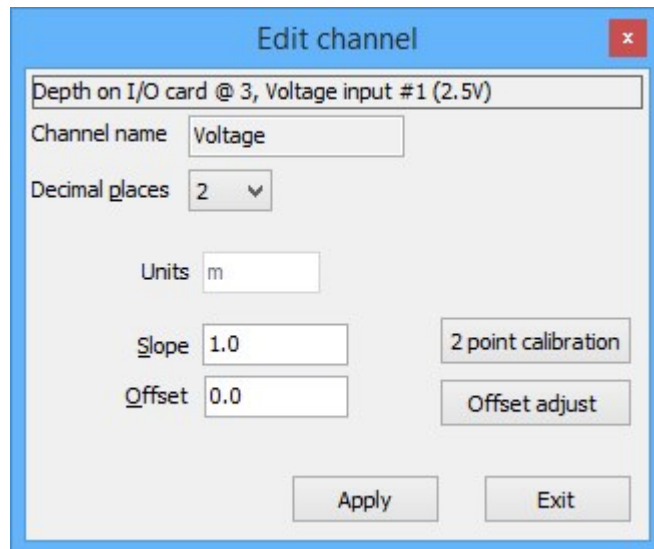

Units

This sets the units on the logged value. This is a text field and is user defined.



NOTE: If a “*Velocity*” or “*Depth*” channel type is configured on a “Card” input the measurement units are defined according to the “[System settings](#)”. If a “*Flowrate*” channel type is configured, a drop-down of both “*Units*” and “*Timebase*” will be provided.

Slope and Offset

See [So, what are "Slope" and "Offset"?](#)

Offset adjust

Perform an “**Offset adjust**” to fine tune the sensor readings. See ["Offset adjust" function](#)

2 point calibration

Perform a “**2 point calibration**” to span the sensor if the “**Slope**” and “**Offset**” values are either unknown or changed. See ["2-Point Calibration" function](#)

"Event (pulse, status change)" - channel type

Add a new "Event (pulse, status change)" channel type

1. In the "**New channel**" dialogue box select the "**I/O Card**" from which the named channel will receive its value.

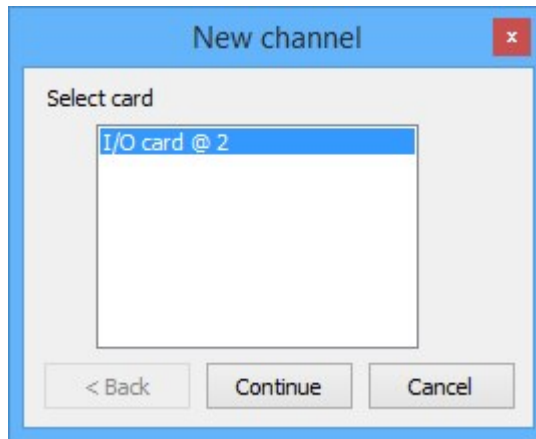

NOTE: As a particular "Cards" input/s becomes fully utilised the card will no longer appear on the "Select card" list.

2. Click "**Continue**" and a new dialogue box will appear with the available input types listed.

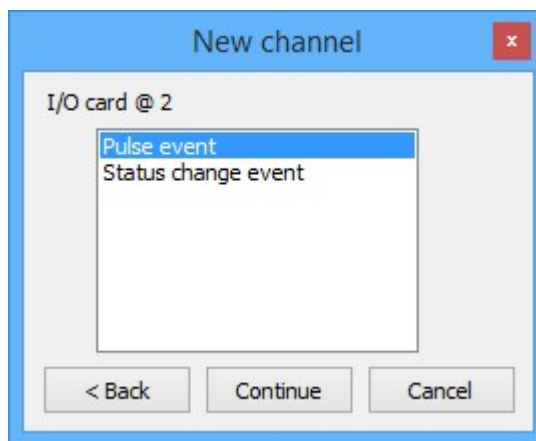

3. Select either the "**Pulse event**" or "**Status change event**" input type from the "**I/O Card @ Slot #**" list. Click "**Continue**" and then select "**Digital input #3**" from which the named channel will receive its value.

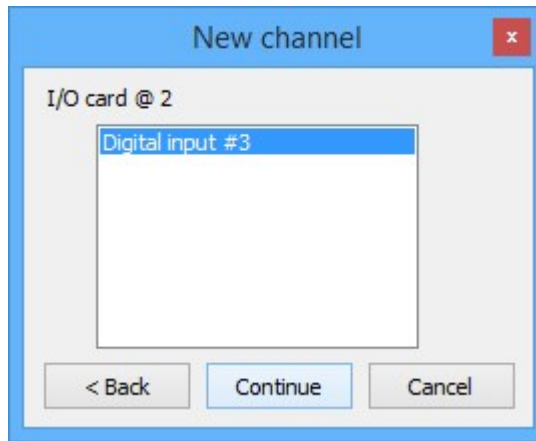

NOTE: Only "Digital input #3" can be used for "Pulse event" or "Status change event" input types

4. Click "**Continue**" to complete the new channel. The "**Configure channels**" dialogue box will re-appear with the new channel listed.

Edit a "Status change event" channel type

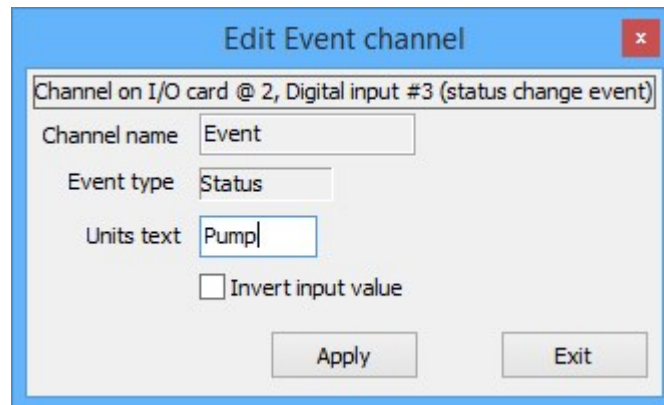

Units text

This sets the units on the logged value. This is a text field and is user defined. In this example the "**Event**" channel is being used to monitor the on/off condition of a pump. In the data the word "**Pump**" will be logged whenever the pump is on.

Invert input

If this check box is ticked then the value will be inverted before it is logged.

Edit a "Pulse event" channel type

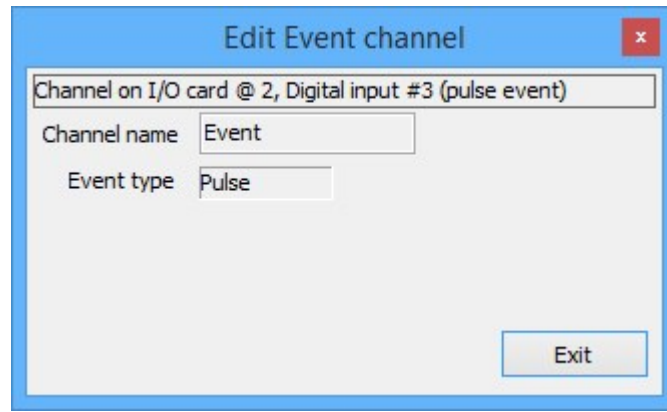

NOTE: None of these parameters can be edited.

"Shaft encoder input" - channel type

Add a new "Shaft encoder input" input type

1. In the "**New channel**" dialogue box select the "**I/O Card**" from which the named channel will receive its value.

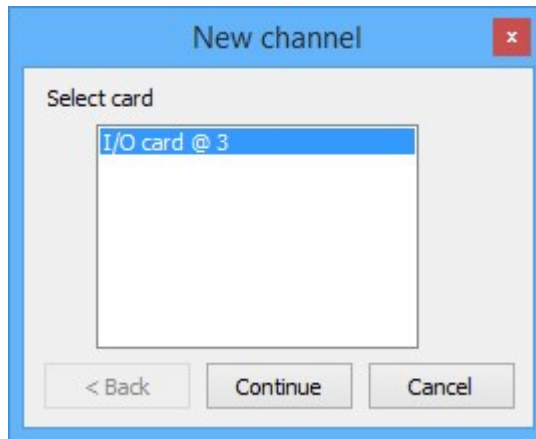

NOTE: As a particular "Cards" input/s becomes fully utilised the card will no longer appear on the "Select card" list.

2. Click "**Continue**" and a new dialogue box will appear with the available input types listed.

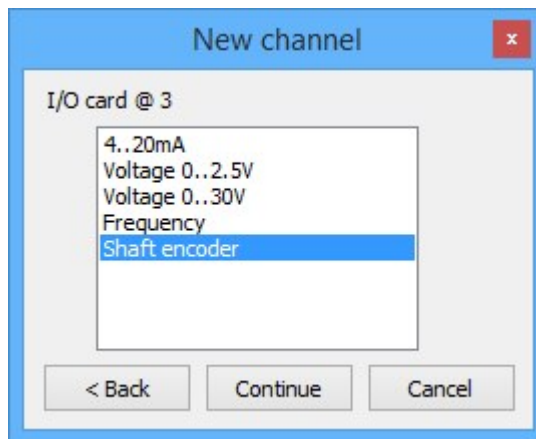

3. Select the "**Shaft encoder**" input type from the "**I/O Card @ Slot #**" list. Click "**Continue**" and then select "**Digital input #1**".



NOTE: Only "**Digital input #1**" can be used for "**Shaft encoder**" input types

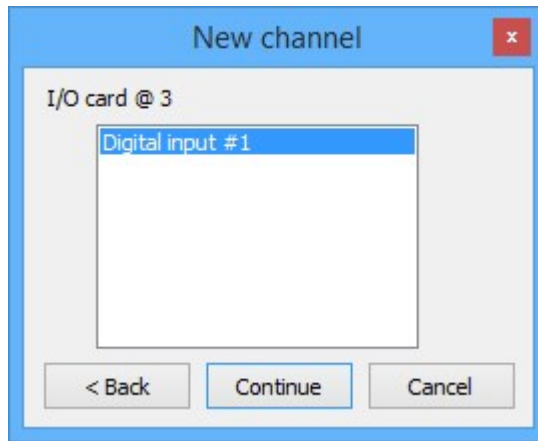

NOTE: As a particular cards inputs are utilised the input will no longer appear on the "*Input*" list.

3. Click "**Continue**" to complete the new channel. The "**Configure channels**" dialogue box will re-appear with the new channel listed.

Edit "Shaft encoder input"

See [So, what are "Slope" and "Offset"?](#)

"Input pulse total" - channel type

Add a new "Input pulse total" channel type

1. In the "**New channel**" dialogue box select the "**I/O Card**" from which the named channel will receive its value.

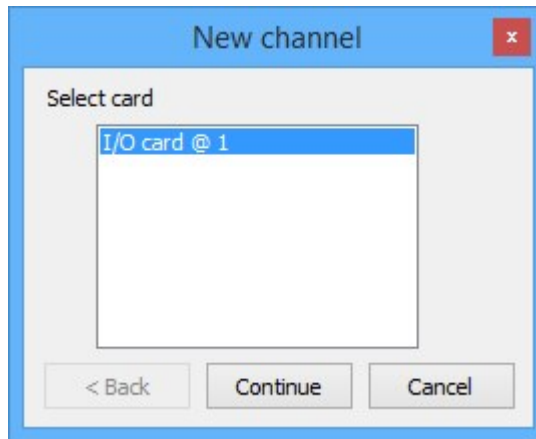

NOTE: As a particular "Cards" input/s becomes fully utilised the card will no longer appear on the "Select card" list.

2. Click "**Continue**" and a new dialogue box will appear with the available input types listed.

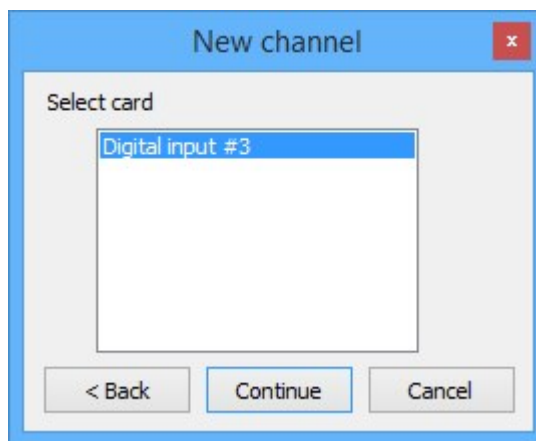

NOTE: Only "Digital input #3" can be used for "Input pulse total" input types

3. Click "**Continue**" to complete the new channel. The "**Configure channels**" dialogue box will re-appear with the new channel listed.

Edit an "Input pulse total" channel type

Channel name Input pulse

Decimal places 2

Units text kL Log pulse event

Factor 1.0

Apply Exit

Units text

This sets the units on the logged value. This is a text field and is user defined.

Log pulse event

If this check box is ticked a "**Status**" message is logged in the data file when the event occurs.

Factor

This field scales the pulse to match the units being used. For example, if 1 kilolitre pulses and megalitre units are used, the factor would be 0.001 where as if 1 kilolitre pulses and kilolitre units are used, the factor would be 1.0

Alternatively when the input is from a rain gauge, if the bucket size is 0.25mm then each pulse will cause the totalizer to increment by that amount

(Eg. 0.25mm, 0.50mm, 0.75mm.....)

"Flowrate (using pulse)" - channel type

This channel is used to calculate a flow rate based upon the number of pulses received by a Pulse I/O card during a measurement interval.

Add a new "Flowrate (using pulse)" channel type

1. In the "**New channel**" dialogue box select the "**Pulse Card**" from which the named channel will receive its value.

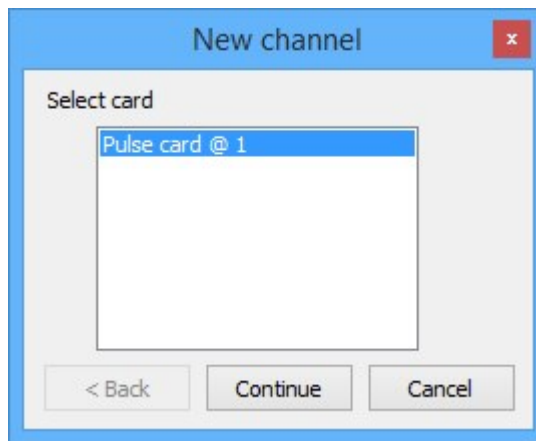

NOTE: As a particular "Cards" input/s becomes fully utilised the card will no longer appear on the "Select card" list.

2. Click "**Continue**" and a new dialogue box will appear with the single "**Pulse input**" listed.

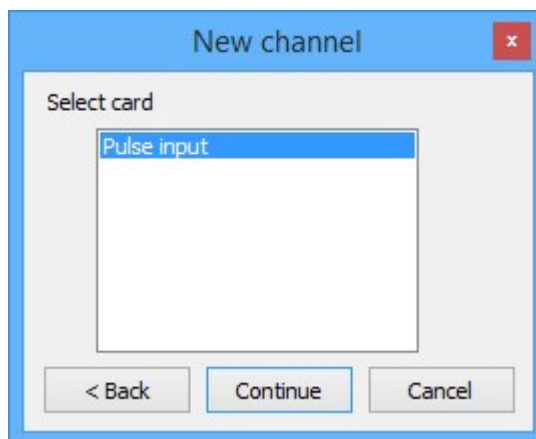

3. Select "**Pulse input**" and click "**Continue**". to complete the new channel. The "**Configure channels**" dialogue box will re-appear with the new channel listed.



NOTE: There is only a single “*Pulse input*” available per “*Pulse card*”.

Edit a "Flowrate (using pulse)" channel type

Flowrate on Pulse card @ 2

Channel name FlowRate (pulse)

Decimal places 2

| /s

K-factor 0.18636 Calibrate

Module Settings ... Apply Exit

Module settings

Pulse Module options

Continuous measurement mode

Averaging time 1 sec

12V sensor supply

Continue

Pulse Module options

Continuous measurement mode

Integration time 1 sec

12V sensor supply

Continue

Continuous measurement mode

If selected, the Pulse card will operate in "**Continuous measurement mode**". In this mode all input pulses will be counted and the pulsing sensor will be continuously powered.

The "**Averaging time**" allows the user to set a period of time over which the pulses will be counted and averaged. This average is then used to calculate a rolling average which may help in applications with unstable flow rate pulsing.

Non-Continuous measurement mode

If the "**Continuous measurement mode**" check box is un-selected, the Pulse card will operate in "**Non-Continuous measurement mode**". The pulsing sensor will only be powered for the "**Integration time**" specified. In this mode input pulses will only be counted for the configured "**Integration time**" at each scheduled "**Measurement interval**".

12V sensor supply

When checked, the sensor will be supplied with 12VDC otherwise it will be powered by 5VDC.



WARNING: “*Sensor power*” must be enabled in the main “*Device settings*” dialogue box or the switching of the power supply will not occur.

Flowrate units

Select the units and the timebase from the drop down list boxes. This sets the units on the logged value.

k-factor

The k-factor scales the input pulses to the selected flow rate units. The k-factor maybe entered directly for sensors with a known pulse rate or the “**Calibrate**” function may be used where it is unknown. See [Calibrate - Flowrate \(using pulse\) function](#) for further details.

Calibrate

See [Calibrate - Flowrate \(using pulse\) function](#)

"SDI-12 Input" - channel types



NOTE: MACE recommends the user studies the relevant documentation supplied with each third party sensor prior to connection.



WARNING: In order to correctly add and configure SDI-12 sensor channel types it is essential to run "*The "SDI-12 Master Utility"*" PRIOR to adding new SDI-12 channels.

Add a new "SDI-12" input type

1. In the "**New channel**" dialogue box select the "**SDI-12 Master card**" from which the named channel will receive its value.

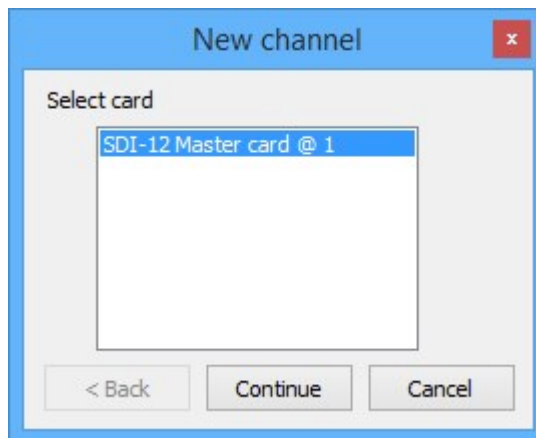

NOTE: As a particular "**Cards**" input/s becomes fully utilised the card will no longer appear on the "**Select card**" list.

2. Click "**Continue**" and a new dialogue box will appear with the "**Sensor address**" and "**Value number**".

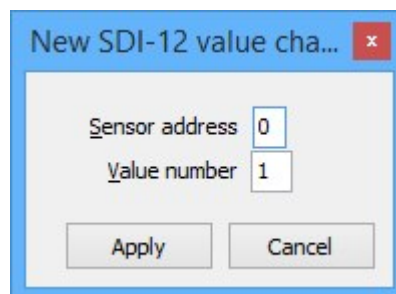



NOTE: These values should have been acquired by running the SDI-12 Master utility.

Sensor Address

Enter the unique sensor address (0 to 9) as acquired using the "**Address query**".

Value number

Enter the "**Value number**" as acquired using a "**Send data**" or "**Read data**" command.

3. Click "**Apply**" and the "**Edit SDI-12 sensor settings**" dialogue box will open.

SDI-12 sensor settings

Address 0 Command C

Measurement command options

Use 'R' command use CRC

Command extension 0

Max. measurement duration 20 s

Apply Cancel

Address

This shows the sensor address on the SDI-12 bus.

Command

This shows the current SDI-12 command that will be sent to the sensor when starting a measuring sequence. By default this will be a "**C**" command.

Use 'R' command

If a concurrent measurement (C) is not to be initiated, check this box.

Use CRC

To enhance error detection, check this box and the data will be returned with a 16-bit cyclic redundancy check (CRC).

Command extension

Command extensions provide a means to request different types of measurements or sensor instructions.

Maximum measurement duration

As identified using the “*SDI-12 master utility*”, a sensor will require a specified time (in seconds) until the sensor will have the measurement ready



WARNING: The user **MUST** add an extra second to the specified time in this text field or the bus may behave erratically.

Edit an "SDI-12" input type

Velocity on SDI-12 Master card, '0': 1

Channel name SDI-12

Decimal places 2

Units m/s

Value number 1

Sensor settings Apply Exit

Units

This sets the units on the logged value. This is a text field and is user defined.



NOTE: If a “*Velocity*” or “*Depth*” channel type is configured on a “*Card*” input the measurement units are defined according to the “[System settings](#)”. If a “*Flowrate*” channel type is configured, a drop-down of both “*Units*” and “*Timebase*” will be provided.

Value number

SDI-12 sensor settings

"Flowrate (using velocity)"- channel type

This channel type is used to calculate a flow rate based upon the results obtained from configured velocity and depth channels.

Add a "Flowrate (using velocity)"- channel type

1. After selecting the ""**Flowrate (using velocity)**" channel type and naming the new channel, the "**Select velocity channel**" dialogue box will appear prompting you to use the drop down list to highlight the "**Velocity channel**" from which the new "**Flowrate (using velocity) channel**" will receive its value.

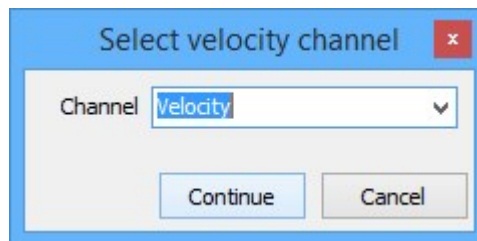

2. Click "**Continue**" and the "**Flowrate measurement type**" dialogue box will appear.

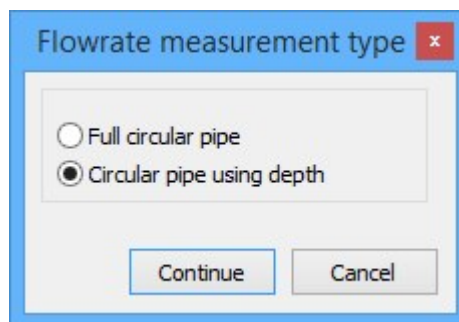

3. Select either "**Full circular pipe**" or "**Circular pipe using depth**" depending upon your application.
4. If you select "**Full circular pipe**", click "**Continue**" to complete the new channel. If you select "**Circular pipe using depth**", click "**Continue**" and the "**Select depth channel**" dialogue box will appear. In the "**Select depth channel**" dialogue box use the drop down list to highlight the "**Depth**" channel from which the "**Flowrate (using velocity)**" channel named will receive its value. Click "**Continue**" to complete the new channel.



NOTE: If “*Other conduit type*” was selected when adding a “*Velocity*” channel, then the “*Flowrate measurement type*” dialogue box will not appear and FloCom+ will automatically prompt for selection of both “*Velocity*” and “*Depth*” channels.

Edit a “Flowrate (using velocity)” - In a full pipe or circular pipe using depth

Flowrate: circular pipe using depth

Channel name: Flow Rate

Decimal places: 2

Velocity channel: Velocity

Depth channel: Depth

Flowrate units: Ml /day

Pipe diameter: 0.45 m

Siltation depth: 0.0 m

Apply Exit

Flowrate units

Select the units and the timebase from the drop down list boxes. This sets the units on the logged value.

Pipe diameter or cross-sectional area

The “*Pipe diameter*” or “*Cross-sectional area*” when configuring a “*Flowrate (using velocity)*” channel is preset when the “*Velocity*” channel is added to the configuration.

Siltation depth

This parameter can be used to correct the calculated flow rate if a known amount of silt is inside the pipe. The depth of silt will be subtracted from the area calculation in order to calculate the corrected flow rate.

Edit a “Flowrate (using velocity)” - In an open channel

When the stream flow is in an open channel (non-circular), the user must determine the cross-sectional area and relate it to depth via a polynomial equation. MACE XCi devices use 5th order polynomial equations.

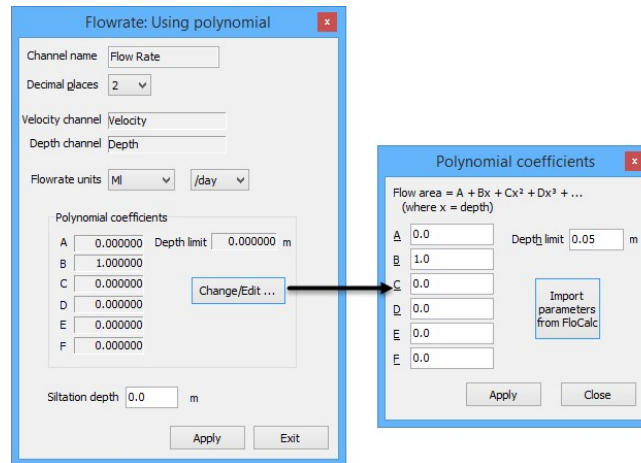

Flowrate units

Select the units and the timebase from the drop down list boxes. This sets the units on the logged value.

Polynomial coefficients

The polynomial coefficients listed in FloCom+ are related to the following equation:

$$\text{Cross-Sectional Area} = A + B \cdot X + C \cdot X^2 + D \cdot X^3 + E \cdot X^4 + F \cdot X^5$$

Where X = depth of stream The coefficients are listed in order A, B, C, D, E, F.

Siltation depth

This parameter can be used to correct the calculated flow rate if a known amount of silt is inside the pipe. The depth of silt will be subtracted from the area calculation in order to calculate the corrected flow rate.

Depth limit

When the cross-sectional area of a stream is calculated using the polynomial coefficient method, the user must set the "**Depth limit**" at which the polynomial reaches a maximum. For example, if a channel has a maximum depth of 1.0m the "**Depth limit**" should be set at 1.0m as well. Alternatively the "**Depth limit**" can be set within *FloCalc* and the procedure described for importing polynomial coefficients.

Import parameters from FloCalc

If the user does not know the coefficients for the polynomial equation, they can be calculated using the MACE utility "*FloCalc*"

Using MACE "*FloCalc*" to calculate polynomial coefficients

The Mace utility program "*FloCalc*" (download separately from www.macemeters.com) can be used to draw regular and irregular channel shapes. These shapes are then converted into a 5th order polynomial. Their coefficients can be imported directly into the appropriate fields in FloCom+

1. Click "**Import parameters from FloCalc**" and MACE FloCalc will open on the "**Profile Designer**" tab sheet.

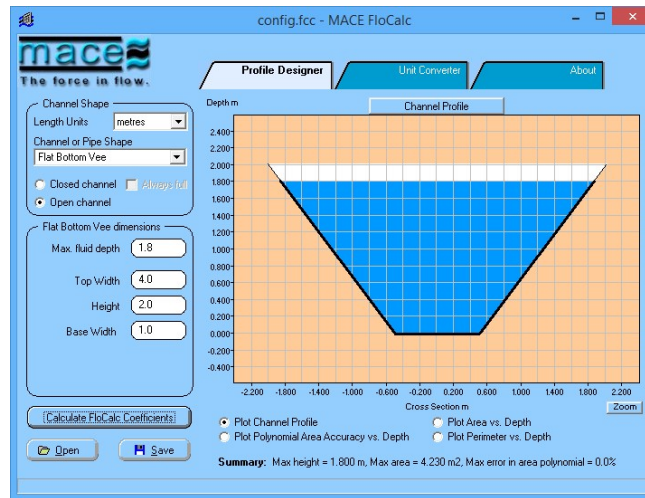

2. Describe/draw your channel or pipe shape using FloCalc (see separate FloCalc Product Manual)
3. Click "**Calculate FloCalc Coefficients**" and the "**MACE FloCalc Coefficients**" dialogue box will appear.

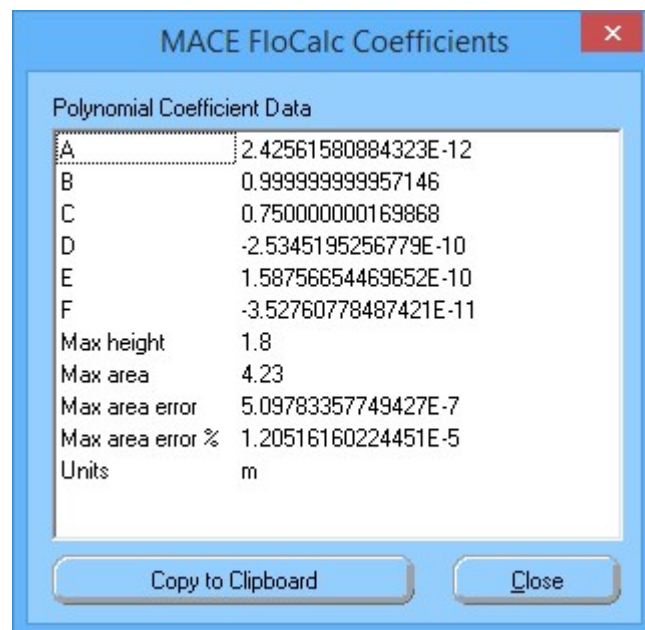

4. Click "**Copy to Clipboard**" then click "**Close**" and exit from FloCalc.
5. The "**FloCalc parameters**" dialogue box will appear containing the calculated polynomial coefficients.
6. Review the coefficients and click "**Apply**" to update the "**Polynomial coefficients**" dialogue box.
7. Click "**Apply**" and the coefficients in the "**Flowrate: Using polynomial**" dialogue box will be set.

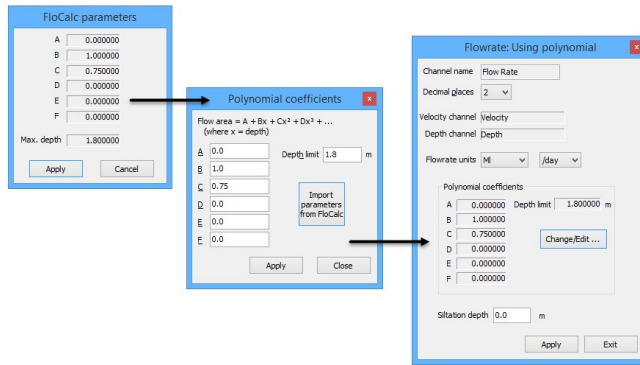

"Flowrate (using velocity)"- channel type

This channel type is used to calculate a flow rate based upon the results obtained from configured velocity and depth channels.

Add a "Flowrate (using velocity)"- channel type

1. After selecting the ""**Flowrate (using velocity)**" channel type and naming the new channel, the "**Select velocity channel**" dialogue box will appear prompting you to use the drop down list to highlight the "**Velocity channel**" from which the new "**Flowrate (using velocity) channel**" will receive its value.

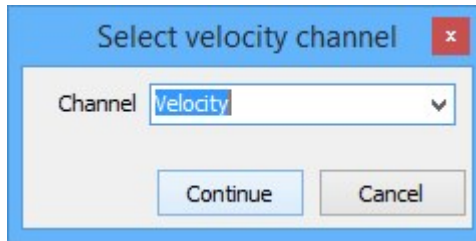

2. Click "**Continue**" and the "**Flowrate measurement type**" dialogue box will appear.

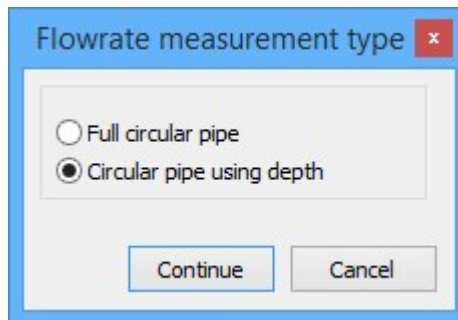

3. Select either "**Full circular pipe**" or "**Circular pipe using depth**" depending upon your application.
4. If you select "**Full circular pipe**", click "**Continue**" to complete the new channel. If you select "**Circular pipe using depth**", click "**Continue**" and the "**Select depth channel**" dialogue box will appear. In the "**Select depth channel**" dialogue box use the drop down list to highlight the "**Depth**" channel from which the "**Flowrate (using velocity)**" channel named will receive its value. Click "**Continue**" to complete the new channel.



NOTE: If "**Other conduit type**" was selected when adding a "**Velocity**" channel, then the "**Flowrate measurement type**" dialogue box will not appear and FloCom+ will automatically prompt for selection of both "**Velocity**" and "**Depth**" channels.

Edit a "Flowrate (using velocity)" - In a full pipe or circular pipe using depth

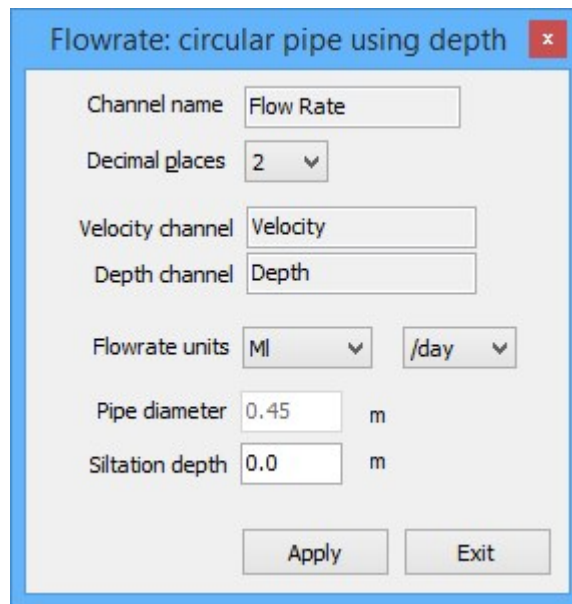

The screenshot shows a configuration dialog box titled "Flowrate: circular pipe using depth". It contains the following fields and controls:

- Channel name: Flow Rate
- Decimal places: 2
- Velocity channel: Velocity
- Depth channel: Depth
- Flowrate units: Ml /day
- Pipe diameter: 0.45 m
- Siltation depth: 0.0 m
- Buttons: Apply, Exit

Flowrate units

Select the units and the timebase from the drop down list boxes. This sets the units on the logged value.

Pipe diameter or cross-sectional area

The "**Pipe diameter**" or "**Cross-sectional area**" when configuring a "**Flowrate (using velocity)**" channel is preset when the "**Velocity**" channel is added to the configuration.

Siltation depth

This parameter can be used to correct the calculated flow rate if a known amount of silt is inside the pipe. The depth of silt will be subtracted from the area calculation in order to calculate the corrected flow rate.

Edit a "Flowrate (using velocity)" - In an open channel

When the stream flow is in an open channel (non-circular), the user must determine the cross-sectional area and relate it to depth via a polynomial equation. MACE XCi devices use 5th order polynomial equations.

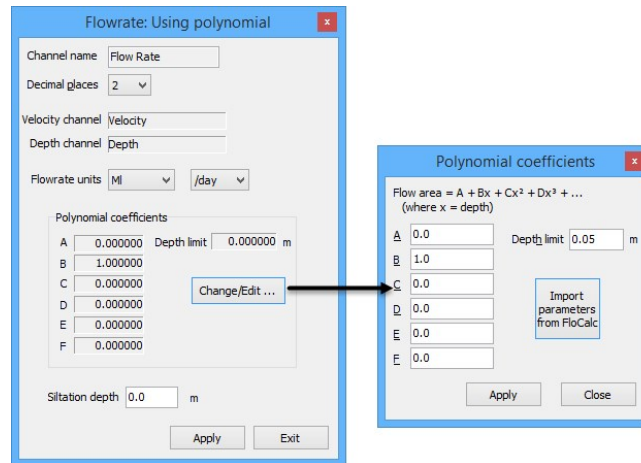

Flowrate units

Select the units and the timebase from the drop down list boxes. This sets the units on the logged value.

Polynomial coefficients

The polynomial coefficients listed in FloCom+ are related to the following equation:

$$\text{Cross-Sectional Area} = A + B \cdot X + C \cdot X^2 + D \cdot X^3 + E \cdot X^4 + F \cdot X^5$$

Where X = depth of stream The coefficients are listed in order A, B, C, D, E, F.

Siltation depth

This parameter can be used to correct the calculated flow rate if a known amount of silt is inside the pipe. The depth of silt will be subtracted from the area calculation in order to calculate the corrected flow rate.

Depth limit

When the cross-sectional area of a stream is calculated using the polynomial coefficient method, the user must set the "**Depth limit**" at which the polynomial reaches a maximum. For example, if a channel has a maximum depth of 1.0m the "**Depth limit**" should be set at 1.0m as well. Alternatively the "**Depth limit**" can be set within *FloCalc* and the procedure described for importing polynomial coefficients.

Import parameters from FloCalc

If the user does not know the coefficients for the polynomial equation, they can be calculated using the MACE utility "*FloCalc*"

Using MACE "FloCalc" to calculate polynomial coefficients

The Mace utility program "*FloCalc*" (download separately from www.macemeters.com) can be used to draw regular and irregular channel shapes. These shapes are then converted into a 5th order polynomial. Their coefficients can be imported directly into the appropriate fields in FloCom+

1. Click "**Import parameters from FloCalc**" and MACE FloCalc will open on the "**Profile Designer**" tab sheet.

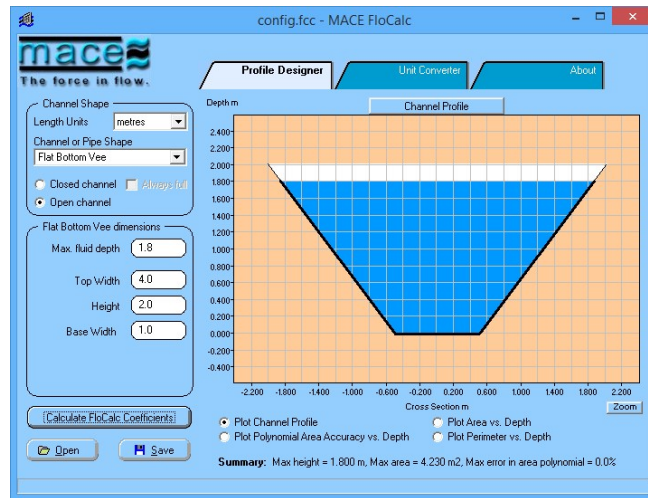

2. Describe/draw your channel or pipe shape using FloCalc (see separate FloCalc Product Manual)
3. Click "**Calculate FloCalc Coefficients**" and the "**MACE FloCalc Coefficients**" dialogue box will appear.

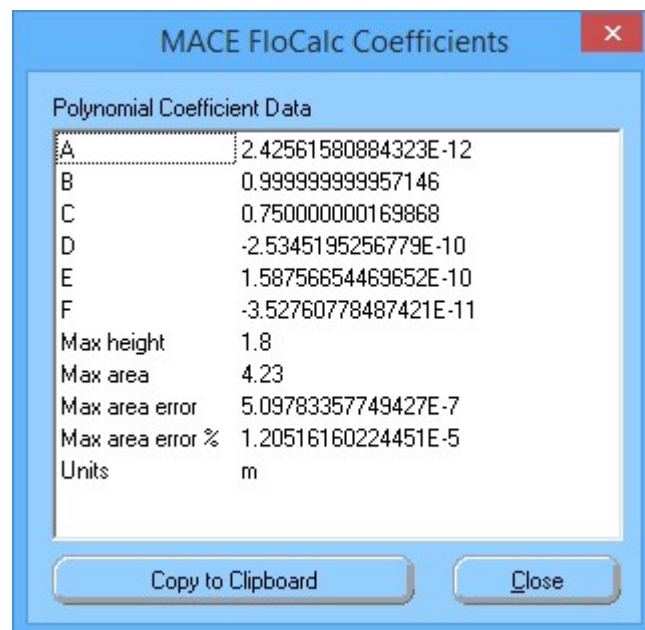

4. Click "**Copy to Clipboard**" then click "**Close**" and exit from FloCalc.
5. The "**FloCalc parameters**" dialogue box will appear containing the calculated polynomial coefficients.
6. Review the coefficients and click "**Apply**" to update the "**Polynomial coefficients**" dialogue box.
7. Click "**Apply**" and the coefficients in the "**Flowrate: Using polynomial**" dialogue box will be set.

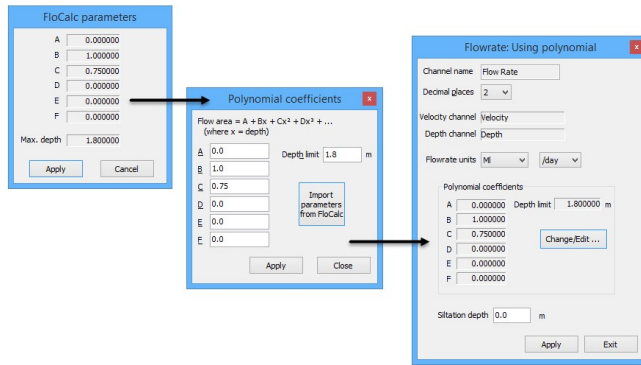

"Flowrate (using lookup table)" - channel type

This channel is used to calculate a flow rate based upon a depth channel and a user configured lookup table of a rated structure.

Add a "Flowrate (using lookup table)" - channel type

1. When adding the "**New channel**" select the related "**Depth**" channel from the drop down list.

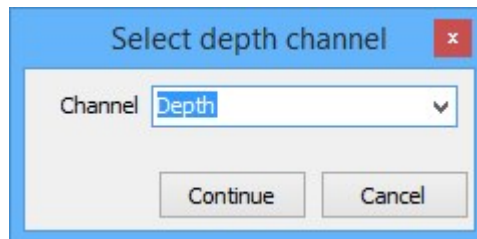

2. Click "**Continue**" and the "**Configure channels**" dialogue box will re-appear with the new channel listed.

Edit a "Flowrate (using lookup table)" - channel type

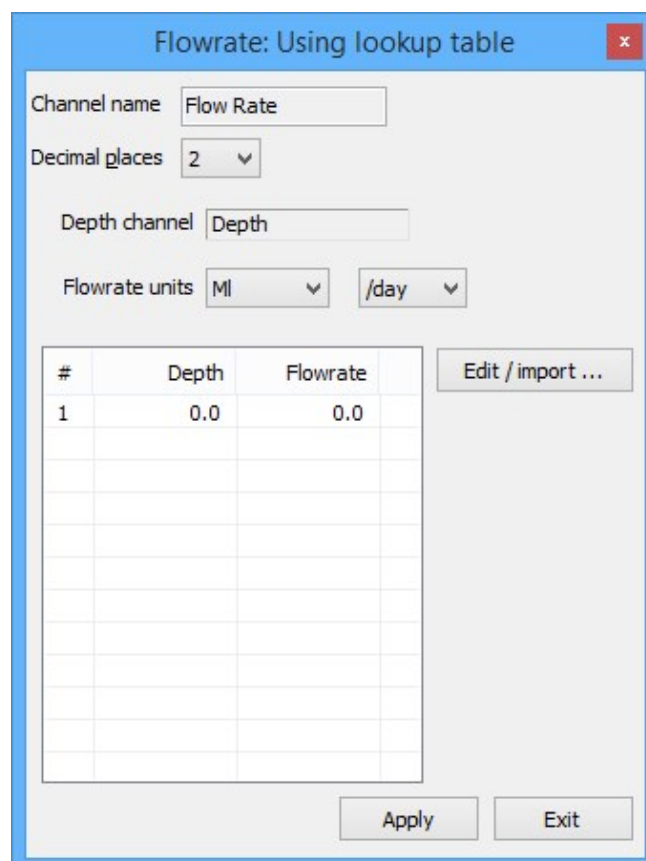

#	Depth	Flowrate
1	0.0	0.0

Flowrate units

Select the units and the timebase from the drop down list boxes. This sets the units on the logged value.

Lookup table values

Lists the flowrates that will be calculated at the corresponding measured depths.



NOTE: The lookup table has a maximum of 35 lines available for use. This maximum is memory dynamic and may be reduced depending upon other channel configurations.

Edit/import

1. From the “**Flowrate: Using lookup table**” dialogue box click “**Edit/import**” and the “**Edit/import LUT data**” dialogue box will appear.
2. Lookup table values can be entered here directly. The depth and corresponding flowrate values must be separated by a comma (,).

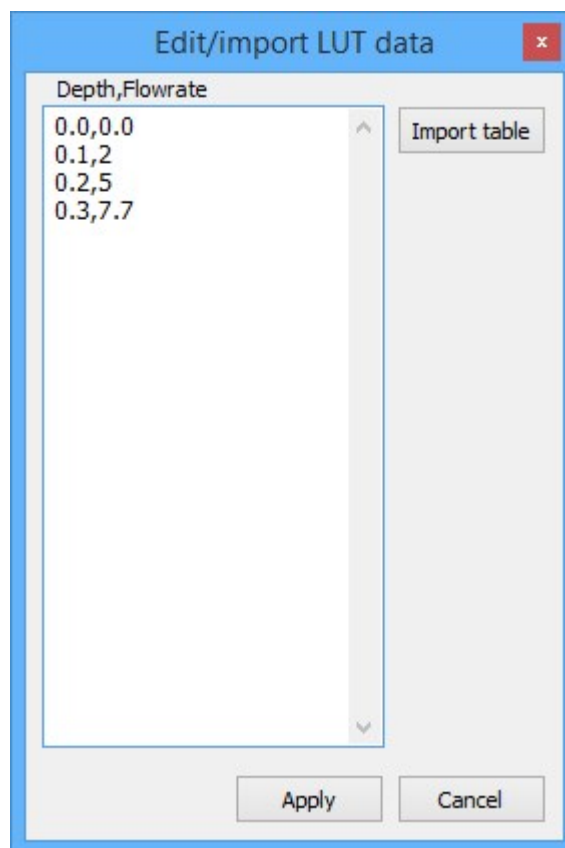

- Alternatively, values may be imported from a *.CSV file. Click "**Import table**" and a Windows® "**Open**" dialogue box will appear prompting the selection of a *.CSV file. Click "**Open**" and the values will be imported.



NOTE: The *.CSV table should be in the format of two columns, one for "**Depth**" and the other "**Flowrate**". Any text in the data will cause a "parsing" error and should be removed for successful import.

- Click "**Apply**" and the "**Flowrate: Using lookup table**" dialogue box will appear containing the updated values.

#	Depth	Flowrate
1	0.0	0.0
2	0.1	2.0
3	0.2	5.0
4	0.3	7.7

"Flowrate (using weir)"- channel type

The HydroMACE XCi device contains in-built equations for allowing users to measure flow rate through rated structures such as flumes and weirs. The table below lists the structures supported and the equations used to calculate flow rate. All of the weir equations assume that the flow is fully contracted, meaning that the approach channel is wide enough and deep enough that the proximity of the floor and sidewalls to the weir opening does not affect the flow (*Tony L. Wahl, Bureau of Reclamation Hydraulics Laboratory in Denver, Colorado, USA*). The equations used by the XCi device's and reproduced [here](#) are used with permission of U.S. Dept. of the Interior, Bureau of Reclamation - Hydraulic Investigations and Laboratory Services Group.

For further information users are encouraged to visit the following website:

www.usbr.gov/pmts/hydraulics_lab/pubs/wmm/index.htm

Add a "Flowrate (using weir)"- channel type

1. When adding the "**New channel**" select the related "**Depth**" channel from the drop down list.

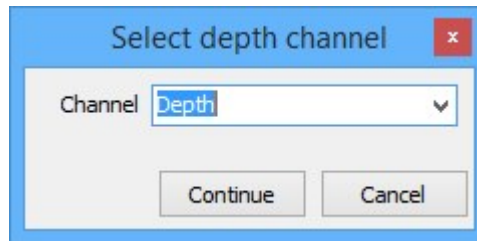

2. Select the weir type that you wish to configure. If you are setting up a flow rate through a Parshall flume, expand the "**Parshall flume**" weir type and select the appropriate flume width from the expanded list.

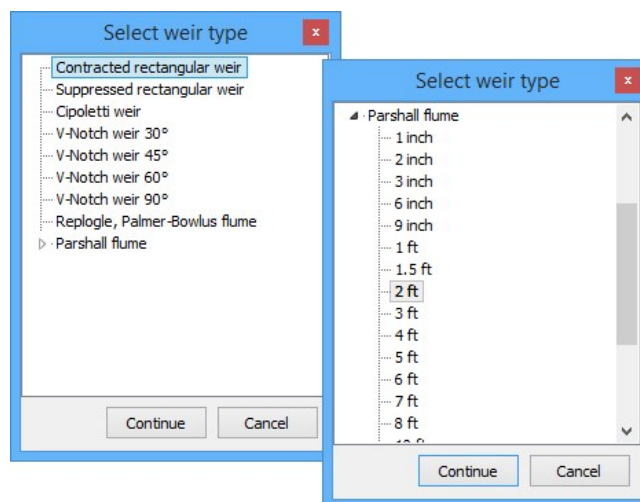

3. Click "**Continue**" and the "**Configure channels**" dialogue box will re-appear with the new channel listed.

Edit a "Flowrate (using weir) - channel type

Flowrate units

Select the units and the timebase from the drop down list boxes. This sets the units on the logged value.

Flowrate (Weir): Rectangular and Cipoletti weirs

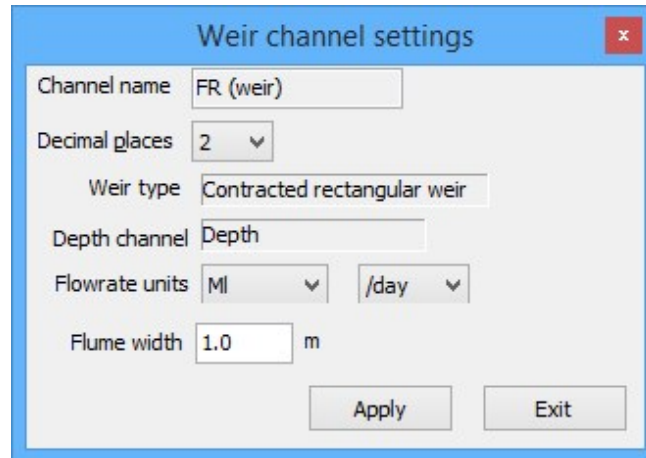

The screenshot shows a dialog box titled "Weir channel settings" with a close button (X) in the top right corner. The dialog contains the following fields and controls:

- Channel name: Text box containing "FR (weir)"
- Decimal places: Dropdown menu set to "2"
- Weir type: Text box containing "Contracted rectangular weir"
- Depth channel: Text box containing "Depth"
- Flowrate units: Two dropdown menus, the first set to "Ml" and the second set to "/day"
- Flume width: Text box containing "1.0" followed by a unit label "m"
- Buttons: "Apply" and "Exit" buttons at the bottom right.

"**Flume width**" - Enter the width of the weir in the units shown. The units are defined according to the "**System settings**".

Flowrate (Weir): V-Notch weirs (30°, 45°, 60°, 90°)

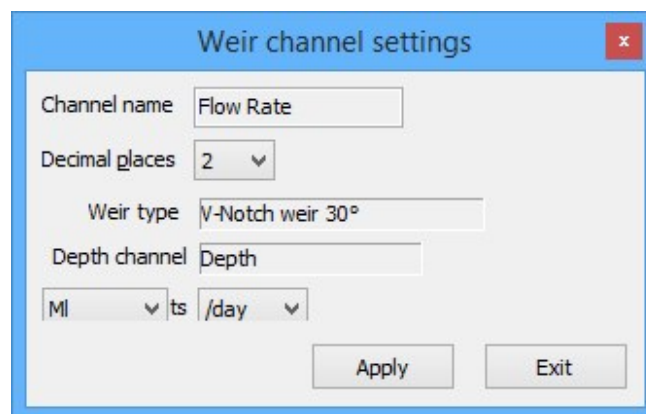

The screenshot shows a dialog box titled "Weir channel settings" with a close button (X) in the top right corner. The dialog contains the following fields and controls:

- Channel name: Text box containing "Flow Rate"
- Decimal places: Dropdown menu set to "2"
- Weir type: Text box containing "V-Notch weir 30°"
- Depth channel: Text box containing "Depth"
- Flowrate units: Two dropdown menus, the first set to "Ml" and the second set to "/day"
- Buttons: "Apply" and "Exit" buttons at the bottom right.

Flowrate (Weir): Replogle, Palmer-Bowlus flumes

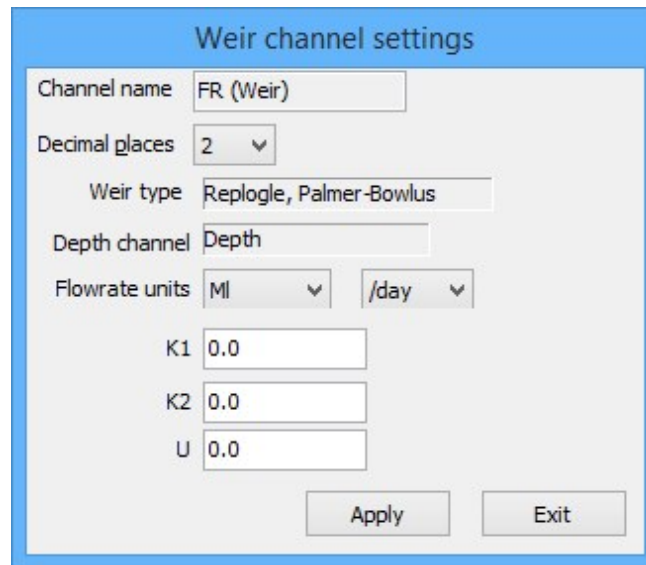

The screenshot shows a dialog box titled "Weir channel settings". It contains the following fields and controls:

- Channel name: FR (Weir)
- Decimal places: 2 (dropdown)
- Weir type: Replogle, Palmer-Bowlus
- Depth channel: Depth
- Flowrate units: Ml (dropdown) /day (dropdown)
- K1: 0.0
- K2: 0.0
- U: 0.0
- Buttons: Apply, Exit

"**Flume factors**" - Long-throated flumes are custom-designed. The values of **K1**, **K2**, and **U** are determined by the designer, using software such as **WinFlume** available from:

[WinFlume](#)

Flowrate (Weir): Parshall flume

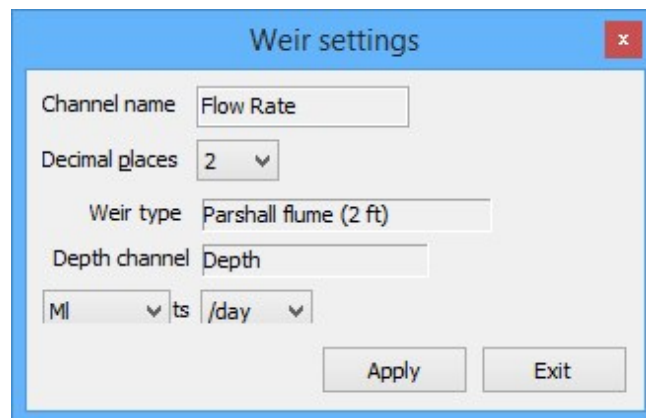

The screenshot shows a dialog box titled "Weir settings". It contains the following fields and controls:

- Channel name: Flow Rate
- Decimal places: 2 (dropdown)
- Weir type: Parshall flume (2 ft)
- Depth channel: Depth
- Flowrate units: Ml (dropdown) ts /day (dropdown)
- Buttons: Apply, Exit

"Flowrate (using trickle flow)" - channel type

This channel uses the Mannings formula to calculate velocity in a circular pipe based upon depth measurement from a MACE Area/Velocity sensor.

The Mannings equation, uses an algorithm to derive the "**Velocity**" of flow in a pipe based on depth, pipe gradient and a "roughness coefficient".

$$V = (\text{CoEff} / N) R_h^{2/3} \cdot S^{1/2}$$

Where:

V = Stream Velocity (ft/s, m/s)

CoEff = 1.49 for US units and 1.0 for metric units

N = Mannings roughness co-efficient (unitless)

R_h = Hydraulic Radius (ft, m)

S = Pipe slope (ft/ft, m/m).



WARNING: There are inherent inaccuracies with using the Mannings equation for calculating "**Velocity**". User should make themselves aware of the limitations of this method **PRIOR** to use.

Add a "Flowrate (using trickle flow)" - channel type



NOTE: The XCi implementation of the Mannings equation into a "**Flowrate (using trickle flow)**" channel uses the derived "**Velocity**" measurement used in conjunction with the "**Depth**" measurement **ONLY** from a MACE A/V Doppler sensor. A "**Flowrate (using trickle flow)**" - channel type can only be added after suitable Doppler "**Velocity**" and "**Depth**" channels have been added to the configuration.

1. After selecting the ""**Flowrate (using trickle flow)**" channel type and naming the new channel, the "**Select velocity channel**" dialogue box will appear prompting you to use the drop down list to highlight the "**Velocity channel**" from which the new "**Flowrate (using trickle flow) channel**" will receive its value.
2. Click "**Continue**" and the "**Select depth channel**" dialogue box will appear. In the "**Select depth channel**" dialogue box use the drop down list to highlight the "**Depth**" channel from which the "**Flowrate (using trickle flow)**" channel named will receive its value. Click "**Continue**" to complete

the new channel.

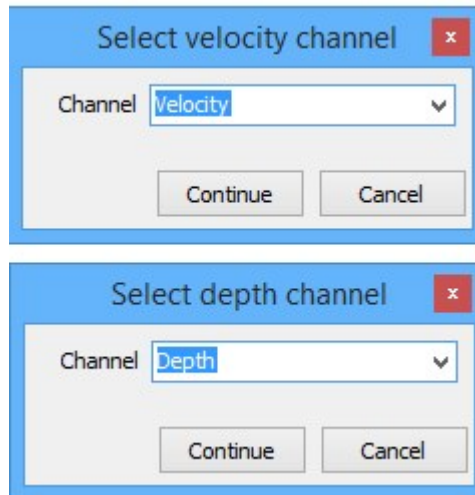

The image shows two sequential dialog boxes. The first is titled "Select velocity channel" and has a dropdown menu with "Velocity" selected. Below the dropdown are "Continue" and "Cancel" buttons. The second dialog is titled "Select depth channel" and has a dropdown menu with "Depth" selected. It also has "Continue" and "Cancel" buttons.



NOTE: This channel uses the MACE Area/Velocity sensor in conjunction with the Mannings equation. This equation is limited to a depth of half-full circular pipe. When the pipe is more than half-full, the "Flowrate (using trickle flow)" channel will revert to using the standard continuity equation $Q = V \times A$.

Edit a "Flowrate (using trickle flow)" - channel type

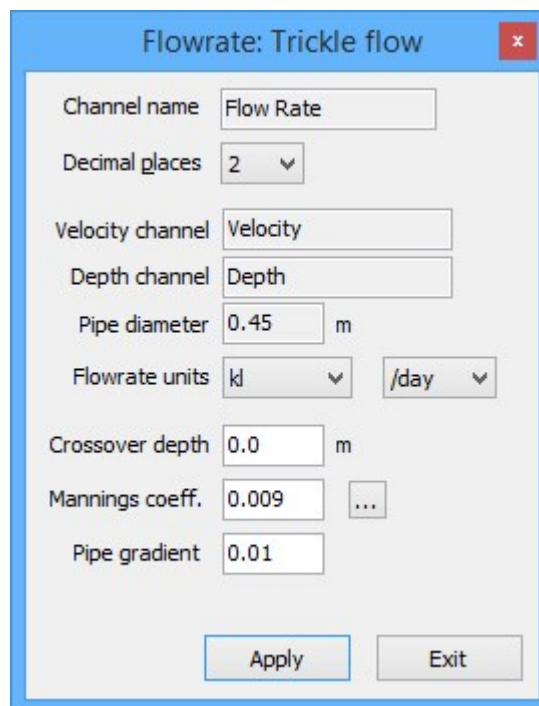

The image shows a configuration dialog titled "Flowrate: Trickle flow". It contains the following fields and controls:

- Channel name: Flow Rate
- Decimal places: 2
- Velocity channel: Velocity
- Depth channel: Depth
- Pipe diameter: 0.45 m
- Flowrate units: kl /day
- Crossover depth: 0.0 m
- Mannings coeff.: 0.009
- Pipe gradient: 0.01

At the bottom are "Apply" and "Exit" buttons.

Flowrate units

Select the units and the timebase from the drop down list boxes. This sets the units on the logged value.

Crossover depth

Enter the depth at which the "**Flowrate (using trickle flow)**" will "crossover" to using the "**Velocity**" value measured by the MACE Area/Velocity Doppler sensor.



NOTE: "*Crossover depth*" is limited to half the diameter of the pipe.

Mannings coeff.

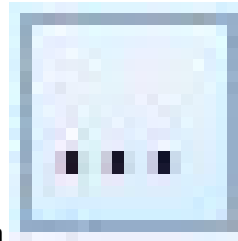

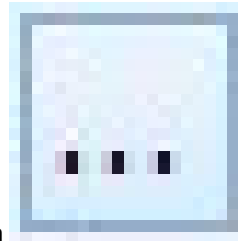
Enter the surface roughness of the pipe. Alternatively, click on  and select one of the published coefficients from the list.



WARNING: Users should be very careful to select the correct surface roughness coefficient for their pipe type. Major errors can be induced with incorrect use

Pipe gradient

Enter the "**Pipe gradient**" of the measuring site. This is calculated and entered as a decimal percentage. For example, a "**Pipe gradient**" of 1% should be entered as "**0.01**"

"Net flowrate" - channel type

This channel is used to calculate positive or negative flowrate based on the results obtained by addition or subtraction of two or more configured flow rate channels.

Add/Edit a "Net flowrate" - channel type

1. The "**Net Flowrate**" channel allows the user to add and subtract all configured "**Flowrate (of any type)**" channels.



NOTE: Only "**Flowrate**" channels with the same flowrate units can be included.



NOTE: Before proceeding, decide the order in which the "**Net flowrate**" channel will be calculated. This is important, as it dictates which "**Flowrate**" channel will be used to "**start**" the equation.

New Net Flowrate channel

Available flowrate channels

Flow Rate 1
Flow Rate 2
Flow Rate 3

Source channel(s)

(Max. 6 source channels)

Flowrate units:

Continue Cancel

2. Highlight the "**Available flowrate channel**" that will start the equation. Click the



button to move the channel to the "**Source channel(s)**" list and the "**Net flowrate channel options**" dialogue will appear.

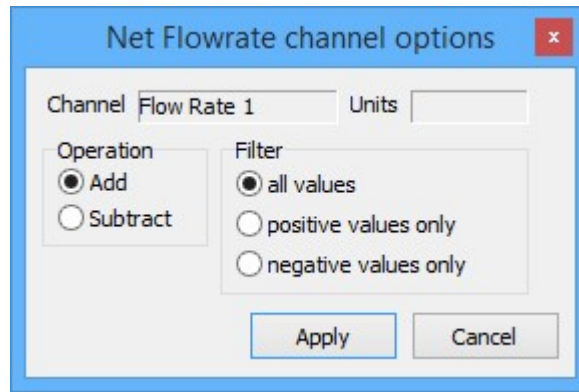

Operation

Check the radio button that matches the operation that you wish to perform on the subsequent "**Flowrate**" channel. In the example, the channel named "**Flow Rate 1**" will be moved to the "**Source channel (s)**" list and the subsequent "**Flowrate**" channel will be added to its value.

Filter

Check the radio button for the "**Flowrate**" channel values that you wish to include in the "**Net flowrate channel**". In the example, the channel named "**Flow Rate 1**" will be used, regardless of whether or not its channel value is positive or negative.

3. Click "**Apply**".
4. Continue to move the channels and edit their "**Net flowrate channel options**" until complete.

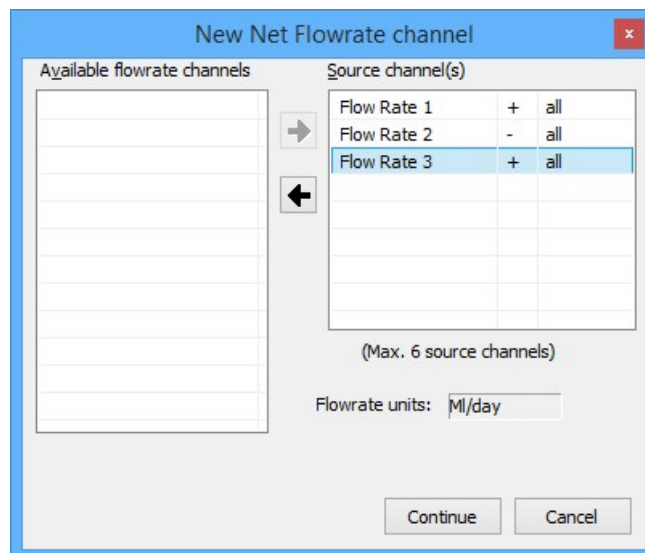



NOTE: In the example, the "*Net flowrate*" will be the sum of "*Flow Rate 1*" + "*Flow Rate 2*" - "*Flow Rate 3*"

"Total flow" - channel type

This channel is used to calculate an accumulated positive or negative total based on the results obtained from configured flow rate channel/s.

Add a "Total flow" - channel type

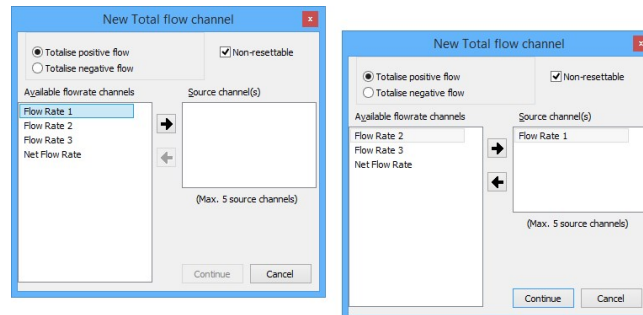

1. From the "**Available flowrate channels**" list, highlight the "**Flowrate**" channel from which the "**Total flow**" channel will receive its value. Click the "**Right arrow**" and the channel will appear in the "**Source channel(s)**" list. A maximum of five flowrate channels can be totalised together.
2. Select either "**Totalise positive flow**" or "**Totalise negative flow**" depending upon your application.



WARNING: The "**Totalise positive flow**" type will only increment the totaliser. If negative flows are recorded the totaliser will NOT decrement. The positive totaliser rolls over to zero.



WARNING: The "**Totalise negative flow**" type will only decrement the totaliser. If positive flows are recorded the totaliser will NOT increment. The negative totaliser rolls over to zero.



NOTE: Both positive and negative flow rates will be recorded in the data file.



NOTE: The "Totaliser" in the XCi device has nine (9) digits (including the user set decimal points).

It will rollover to zero after 999999999 *units*.

With decimal points it will rollover at:

99999999.9 or

999999.99 or

99999.999

3. If the "**Non-resettable**" checkbox is ticked, this total flow channel will not be re-settable using the "**Set/reset**" procedure from the "**View totals**" main menu item.



NOTE: If the "**Non-resettable**" checkbox is ticked, this total flow channel will not be re-settable using the front panel button press [procedure](#).

4. Click "**Continue**" to complete the new channel and the "**Configure channels**" dialogue box will re-appear with the new channel listed.

Edit a "Total flow" - channel type

Total flow, positive, non-resettable

Channel name: Total

Decimal places: 2

Flow volume units: Ml

Flowrate channel(s): Flow Rate 1

Apply Exit

Flow volume units

Select the units from the drop down list box. This sets the units on the logged value.

"Net flow total" - channel type

This channel is used to calculate an accumulated positive or negative total based on the results obtained by addition or subtraction of two or more configured flow rate channels.

Add/Edit a "Net flow total" - channel type

1. The "**Net flow total**" channel allows the user to add and subtract all configured "**Flowrate (of any type)**" channels and accumulate a totalised value.



NOTE: Only "**Flowrate**" channels with the same flowrate units can be included.



NOTE: Before proceeding, decide the order in which the "**Net flow total**" channel will be calculated. This is important, as it dictates which "**Flowrate**" channel will be used to "**start**" the equation.

New Net Flow Total channel

Available flowrate channels

Flow Rate 1
Flow Rate 2
Flow Rate 3

Source channel(s)

(Max. 6 source channels)

Flowrate units:

Flow volume units: MI

Non-resettable

Continue Cancel

2. Highlight the "**Available flowrate channel**" that will start the equation. Click the



button to move the channel to the "**Source channel(s)**" list and the "**Net flowrate channel options**" dialogue will appear.

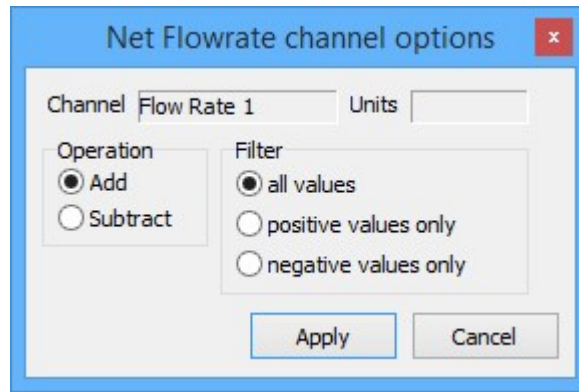

Operation

Check the radio button that matches the operation that you wish to perform on the subsequent "**Flowrate**" channel. In the example, the channel named "**Flow Rate 1**" will be moved to the "**Source channel (s)**" list and the subsequent "**Flowrate**" channel will be added to its value.

Filter

Check the radio button for the "**Flowrate**" channel values that you wish to include in the "**Net flow total channel**". In the example, the channel named "**Flow Rate 1**" will be used, regardless of whether or not its channel value is positive or negative.

3. Click "**Apply**".
4. Continue to move the channels and edit their "**Net flowrate channel options**" until complete.

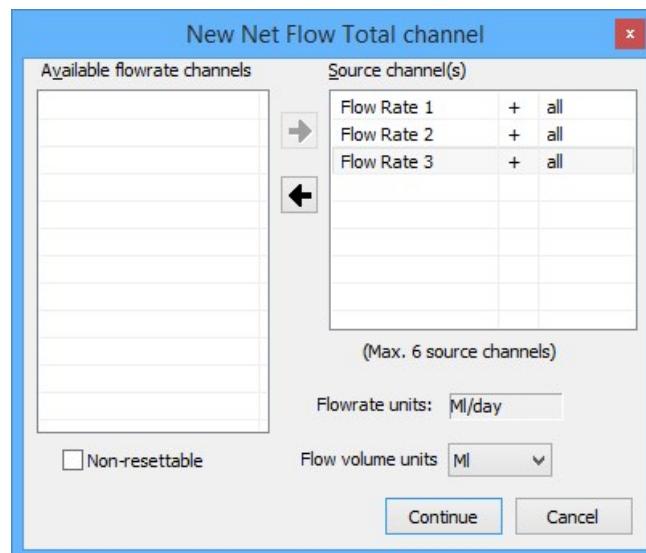



NOTE: In the example, the "*Net flow total*" will be the sum of "*Flow Rate 1*" + "*Flow Rate 2*" + "*Flow Rate 3*"

5. If the "**Non-resettable**" checkbox is ticked, this total flow channel will not be re-settable using the "**Set/reset**" procedure from the "**View totals**" main menu item.



NOTE: If the "**Non-resettable**" checkbox is ticked, this total flow channel will not be re-settable using the front panel button press [procedure](#).

"Channel value status" - channel type

The "**Channel value level status**" and "**Channel value range status**" channel types are used in conjunction with a "**Binary status output**" in order to turn pumps (irrigation, dosing, wet-well etc.) and other ancillary devices ON/OFF based on various measured parameter values.



WARNING: The *Binary Status Output* is provided as is, without any guarantees or warranty. MACE makes no warranties of any kind, either express or implied, including but not limited to warranties of merchantability or fitness for a particular purpose. Use of this feature is at the user's risk.



NOTE: The *Binary Status Output* is set to OFF when the XCi device is first "Started", when it is "Stopped" or in a "Flat battery state".

Add a new "Channel value level or range status" channel type

1. Name the "**New channel**" and click "**Continue**".
2. Select the physical channel from which the "**Level or Range Status**" will receive its input via the drop-down list.

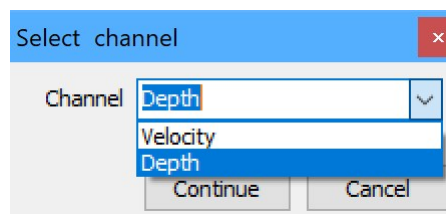

3. Click "**Continue**" to complete the new channel. The "**Configure channels**" dialogue box will re-appear with the new channel listed.

Edit a "Channel value level status" channel type

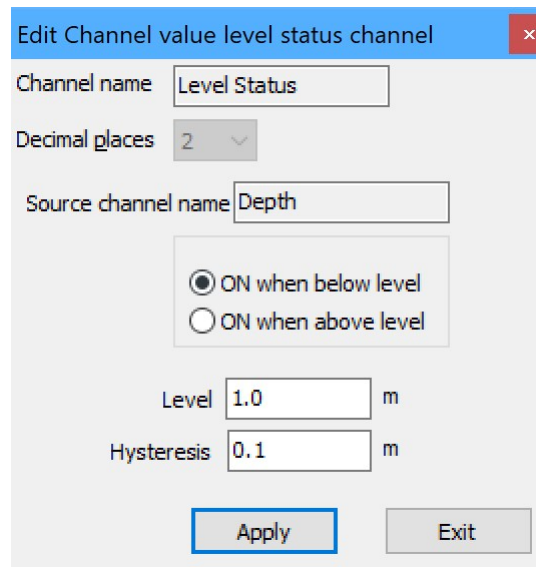

Dialog box titled "Edit Channel value level status channel" with the following fields and options:

- Channel name: Level Status
- Decimal places: 2
- Source channel name: Depth
- Radio button options:
 - ON when below level
 - ON when above level
- Level: 1.0 m
- Hysteresis: 0.1 m
- Buttons: Apply, Exit

ON when below level

The related "[Binary status output](#)" will be turned ON when the input channel value is less than the "**Level value**", and OFF when the input channel value is greater than the "**Level value**" plus the "**Hysteresis value**".

OFF when above level

The related "[Binary status output](#)" will be turned ON when the input channel value is greater than the "**Level value**", and OFF when the input channel value is less than the "**Level value**" minus the "**Hysteresis value**".

In the example above, the "Binary status output" will be turned ON, when the "Source channel named - Depth" has a value of less than 1.0 metres and OFF when the "Source channel named - Depth" has a value of greater than 1.1 metres.

Edit a "Channel value range status" channel type

Dialog box titled "Edit Channel value range status channel" with the following fields and options:

- Channel name: Range Status
- Decimal places: 2
- Source channel name: Depth
- Radio buttons:
 - ON when outside range
 - ON when inside range
- Upper limit: 1.0 m
- Lower limit: 0.5 m
- Hysteresis: 0.1 m
- Buttons: Apply, Exit

ON when outside range

The related "[Binary status output](#)" will be turned ON when the input channel value is greater than the "**Upper limit**" or less than the "**Lower limit**". The related "[Binary status output](#)" will be turned OFF if the input channel value is greater than the "**Lower limit**" plus the "**Hysteresis value**" or less than the "**Upper limit**" minus the "**Hysteresis value**".

OFF when inside range

The related "[Binary status output](#)" will be turned ON when the input channel value is less than the "**Upper limit**" and greater than the "**Lower limit**". The related "[Binary status output](#)" will be turned OFF if the input channel value is greater than the "**Upper limit**" plus the "**Hysteresis value**" or less than the "**Lower limit**" minus the "**Hysteresis value**".

In the example above, the "Binary status output" will be turned ON, when the "Source channel named - Depth" has a value of between 1.0 and 0.5 metres, and OFF if the "Source channel named - Depth" has a value of greater than 1.1 metres or less than 0.4 metres.



NOTE: A "Binary status output" must now be added and configured.

"Velocity (depth corrected)" - channel type

This channel is used to apply a correction factor to measured velocity data based upon different depth regimes of the stream.

Unfortunately, ideal hydraulic conditions cannot be achieved at every site that requires monitoring. If you are in a situation where hydraulic conditions are such that velocity calibrations at various flow regimes are required, then the "**Velocity (depth corrected)**" channel may help. Under abnormal hydraulic conditions, the average velocity of the stream must be calculated using traditional means that comply with international standards (refer to AS3778 series or ISO772). The calibration will need to be done at various depths and the calculated velocity/MACE Doppler velocity ratio determined. You can then apply the ratio to the data. For example, if you measure the average velocity of a stream to be 0.95m/s and the MACE Doppler velocity sensor is measuring 1.0m/s then the velocity ratio will be 0.95/1.0. (or 0.95). In the example below, a stream is measured at four depth regimes and four ratios have been determined. Situations such as a gravity type sewer with a bend upstream may result in the need to use this function. If the hydraulic conditions are reasonable at the site you choose to monitor then there is no need to use this function.

Add a "Velocity (depth corrected)" - channel type

1. After selecting the ""**Velocity (depth corrected)**" channel type and naming the new channel, the "**Select velocity channel**" dialogue box will appear prompting you to use the drop down list to highlight the "**Velocity channel**" from which the new "**Velocity (depth corrected)**" channel" will receive its value.
2. Click "**Continue**" and the "**Select depth channel**" dialogue box will appear. In the "**Select depth channel**" dialogue box use the drop down list to highlight the "**Depth**" channel from which the "**Velocity (depth corrected)**" channel named will receive its value. Click "**Continue**" to complete the new channel.

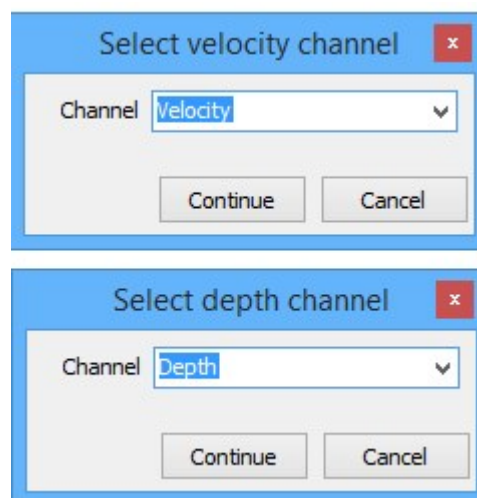

Edit a "Velocity (depth corrected)" - channel type

Edit depth corrected velocity channel ✕

Channel name

Decimal places

Velocity channel

Depth channel

Velocity factors

No. of zones

Zone	Factor	Upper depth limit
1.	<input type="text" value="1.0"/>	(Max. depth)
2.	<input type="text" value="0.95"/>	<input type="text" value="0.8"/> m
3.	<input type="text" value="1.05"/>	<input type="text" value="0.7"/> m
4.	<input type="text" value="1.01"/>	<input type="text" value="0.3"/> m

No. of zones

Enter the number of "flow regimes" that have had velocity calibrations performed. A maximum of four (4) zones is applicable

Factor

The calculated ratio to be applied to the "**Velocity**" channel data.

Depth

Enter the zone depth limits here. For example,

"**Factor ratio**" for "**Zone 4**" will be applied for stream depths between zero (0) and 0.3m.

"**Factor ratio**" for "**Zone 3**" will be applied for stream depths between 0.3m and 0.7m.

"**Factor ratio**" for "**Zone 2**" will be applied for stream depths between 0.7m and 0.8m.

"**Factor ratio**" for "**Zone 1**" will be applied for stream depths between 0.8m and maximum depth.



NOTE: All depths as measured by the associated "**Depth**" channel

"Volume (using lookup table)" - channel type

This channel is used to calculate the volume of a storage (dam/tank) based upon a depth measurement and a user configured lookup table of the storage geometry.

Add a "Volume (using lookup table) - channel type

1. When adding the "**New channel**" select the related "**Depth**" channel from the drop down list.

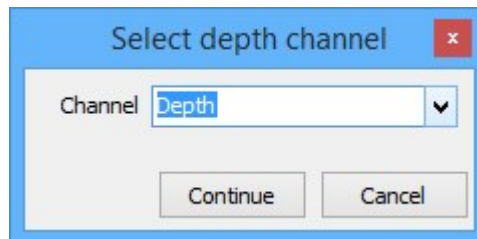

2. Click "**Continue**" and the "**Configure channels**" dialogue box will re-appear with the new channel listed.

Edit a "Volume (using lookup table) - channel type

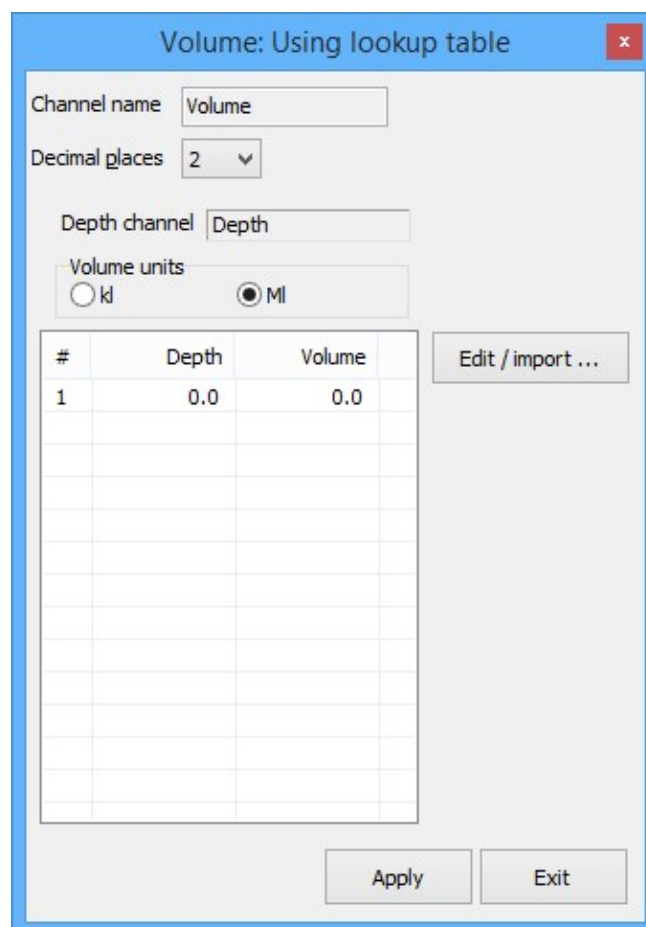

Volume units

Select the units using the radio buttons. This sets the units on the logged value.

Lookup table values

Lists the volumes that will be calculated at the corresponding measured depths.



NOTE: The lookup table has a maximum of 50 lines available for use. This maximum is memory dynamic and may be reduced depending upon other channel configurations.

Edit/import

1. From the "**Volume: Using lookup table**" dialogue box click "**Edit/import**" and the "**Edit/import LUT data**" dialogue box will appear.
2. Lookup table values can be entered here directly. The depth and corresponding volume values must be separated by a comma (,).

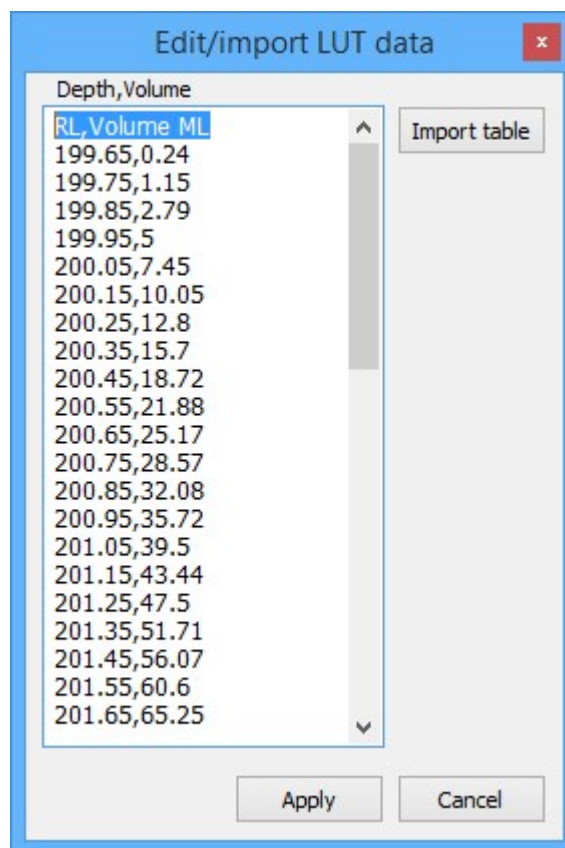

- Alternatively, values may be imported from a *.CSV file. Click "**Import table**" and a Windows® "**Open**" dialogue box will appear prompting the selection of a *.CSV file. Click "**Open**" and the values will be imported.



NOTE: The *.CSV table should be in the format of two columns, one for "**Depth**" and the other "**Volume**". Any text in the data will cause a "parsing" error and should be removed for successful import.

- Click "**Apply**" and the "**Volume: Using lookup table**" dialogue box will appear containing the updated values.

#	Depth	Volume
1	199.65	0.24
2	199.75	1.15
3	199.85	2.79
4	199.95	5.0
5	200.05	7.45
6	200.15	10.05
7	200.25	12.8
8	200.35	15.7
9	200.45	18.72
10	200.55	21.88
11	200.65	25.17
12	200.75	28.57
13	200.85	32.08
14	200.95	35.77

"Device battery voltage" - channel type

This channel is used to monitor the XCi device internal battery voltage.



"Device external voltage" - channel type

This channel is used to monitor the XCi device external voltage from a solar panel or mains charger.

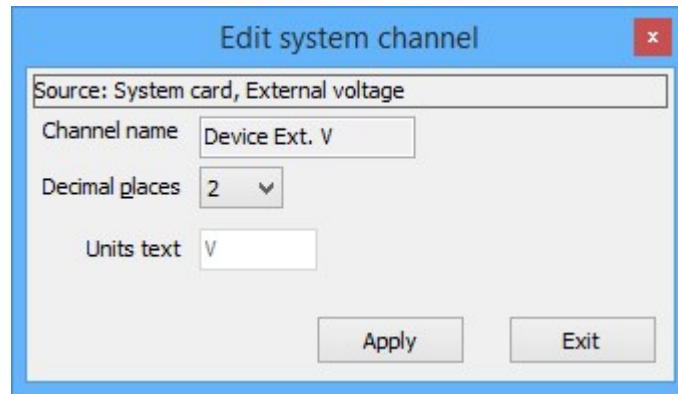

The image shows a software dialog box titled "Edit system channel" with a red close button in the top right corner. The dialog contains the following fields and controls:

- A text box at the top containing "Source: System card, External voltage".
- A "Channel name" label followed by a text box containing "Device Ext. V".
- A "Decimal places" label followed by a dropdown menu showing the number "2".
- A "Units text" label followed by a text box containing "V".
- At the bottom right, there are two buttons: "Apply" and "Exit".

"Measure and Display" function

The "**Measure and Display**" function enables the user to check that all XCi channel types configured are "working". This function will update the channel values based upon the longest time period that a particular channel configuration requires to output a value. For example, if a depth sensor requires a 25 second "warm-up", then the values will be updated every 25 seconds. If a Doppler "**Velocity**" channel requires 30 seconds to calculate a velocity, then the values will be updated every 30 seconds and so on.

1. From the "**Edit configuration settings**" dialogue, click "**Measure and Display**" and the "**View measurement**" dialogue box will open.

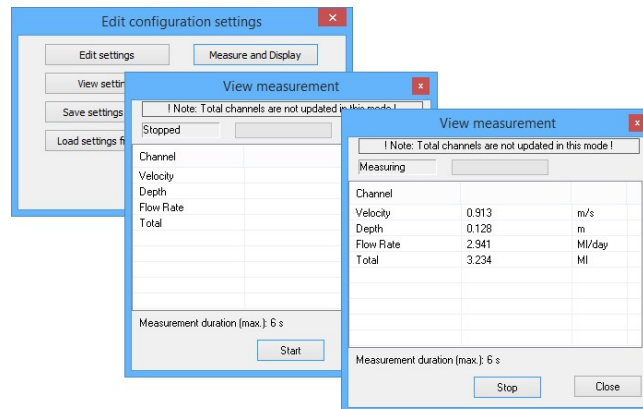

2. Click "**Start**" and the progress bar at the top will begin to advance every second.
3. After all "**Channels**" have been received and/or calculated the "**Channel**" values will be updated.
4. Click "**Stop**" then "**Close**" to return to the "**Edit configuration settings**" dialogue.



NOTE: "Total" channels are not updated in "Measure and Display"

For a short video of the procedure click "**Play**"-

"Offset adjust" function

This function is used to "fine tune" a sensor reading whenever a sensor is deployed or reading inaccurately. For example, a depth sensor may be sitting slightly off the bottom of the stream, or the user has deployed it above a silt line on the side of a pipe.

1. Click "**Offset adjust**" from the "**Edit channel**" dialogue box and the "**Channel offset adjust**" dialogue box appears.

The "**Current value**" from the sensor (in this case a depth sensor with frequency output) is displayed at the top of the window and is updated approximately once per second.

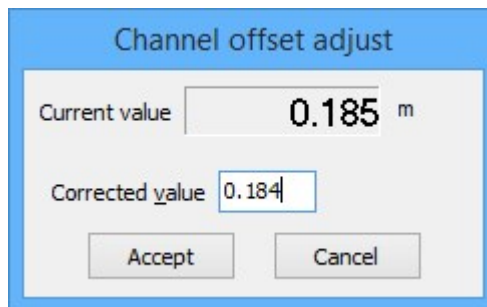

2. To adjust the "**Current value**", enter your current measured value in the "**Corrected value**" field.
3. Click on the "**Accept**" button to calculate the new "**Offset**" parameter value for the associated channel. Clicking on the "**Cancel**" button terminates the procedure without altering the offset value.

For a short video of the procedure click "**Play**"-



WARNING: When calibrating a "Depth" channel, measurements should ALWAYS be carried out from the bottom of the channel/pipe to the top of the water level

"2-Point Calibration" function

To correctly calibrate an environmental sensor it is important to calibrate it over its useful range. For example, if a depth sensor has a range of 0 - 2 metres but you only wish to use it to measure the range 0.0 metres to 1.25 metres, you should re-calibrate it across the reduced range.

1. Click "**2-point calibration**" from the "**Edit channel**" dialogue box and the "**2 point calibration**" dialogue box appears.

The "**Current value**" from the sensor (in this case a depth sensor with frequency output) is displayed at the top of the window and is updated approximately once per second.

2. To carry out a two point calibration, prepare the measurement set up for the first calibration point (either the sensors upper or lower range limit).
3. When the "**Current value**" has stabilised, click on the "**Set**" button in the "**1st point**" box. The "**Current value**" is copied to the "**Measured value**" field of the "**1st point**" box and the "**Actual value**" field is enabled.

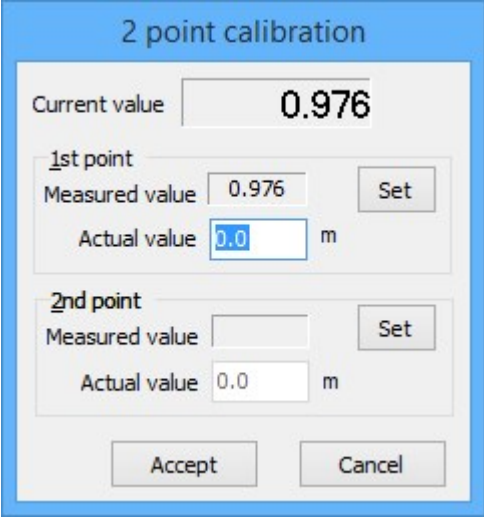

The screenshot shows a dialog box titled "2 point calibration". At the top, "Current value" is displayed as 0.976. Below this, there are two sections for calibration points. The "1st point" section has a "Measured value" field containing 0.976 and a "Set" button. The "Actual value" field is set to 0.0 m and is highlighted with a blue selection box. The "2nd point" section has an empty "Measured value" field and a "Set" button. Its "Actual value" field is set to 0.0 m. At the bottom of the dialog are "Accept" and "Cancel" buttons.

4. Enter the sensors actual value (in this case depth) in the "**Actual value**" field.
5. Prepare the measurement set up for the second calibration point (the opposite sensor range limit from that used in point 2 above). For example, if you used the upper range limit in point 2, now use the lower range limit.
6. When the "**Current value**" has stabilised, click on the "**Set**" button in the "**2nd point**" box. The "**Current value**" is copied to the "**Measured value**" field of the "**2nd point**" box and the "**Actual value**" field is enabled.

2 point calibration

Current value

1st point

Measured value

Actual value m

2nd point

Measured value

Actual value m

7. Enter the sensors actual value (in this case depth) in the “**Actual value**” field.
8. Click on the “**Accept**” button to calculate the new slope and offset parameter values for the associated channel. Clicking on the “**Cancel**” button terminates the procedure without altering the parameter values.

For a short video of the procedure click "**Play**"-

The "SDI-12 Master Utility"



WARNING: In order to correctly add and configure SDI-12 sensor channel types it is essential to run the "SDI-12 Master utility" PRIOR to adding new SDI-12 channels

This utility provides the user with a simple SDI-12 interface to communicate with connected smart sensors. The user can send all defined SDI-12 commands as implemented in Version 1.3 of the SDI-12 Protocol specification.

Download from <http://www.sdi-12.org>

1. From the "**Device settings**" dialogue box click "**SDI-12 Master utility**".

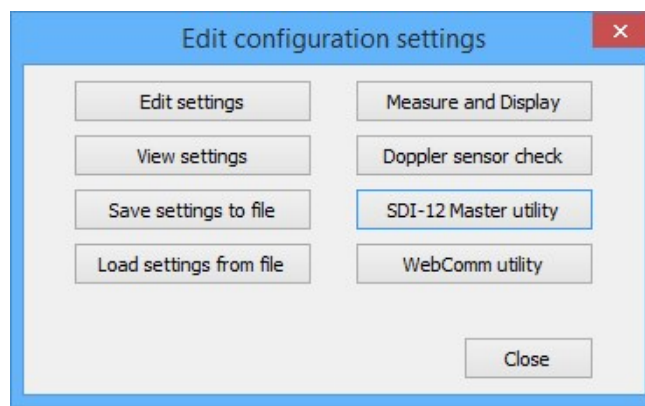

2. Highlight the "**SDI-12 Master card**" that the sensor/s are connected too, click "**Continue**" and the SDI-12 Master card utility will be activated in the new dialogue box.

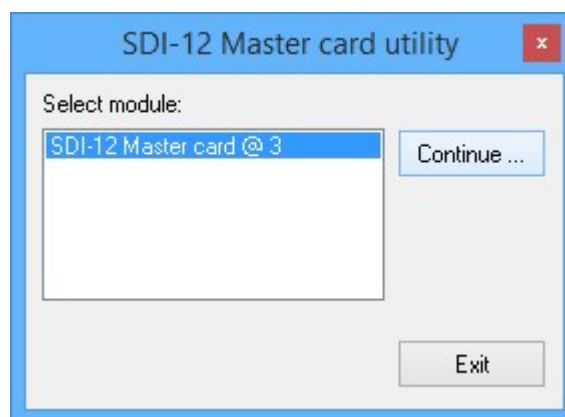

3. Select the radio button for the command you wish to send, then click "**Send command**".

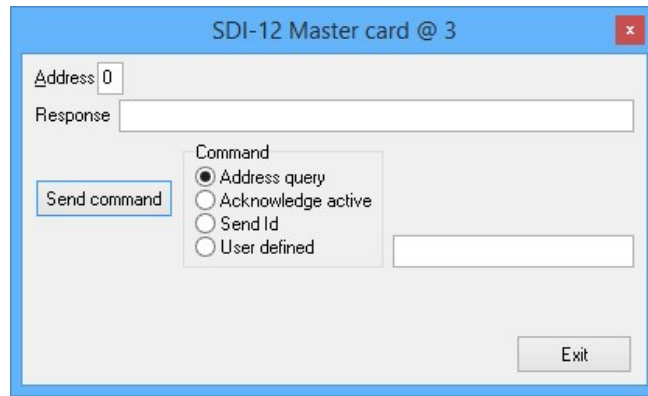

WARNING: If an incorrect SDI-12 command is sent or a command is sent to the wrong sensor address the SDI-12 Master Utility “Response” will be <error>.

"Address query"

Click “**Send command**” and the sensor will respond with the sensor address in the “**Response**” field.

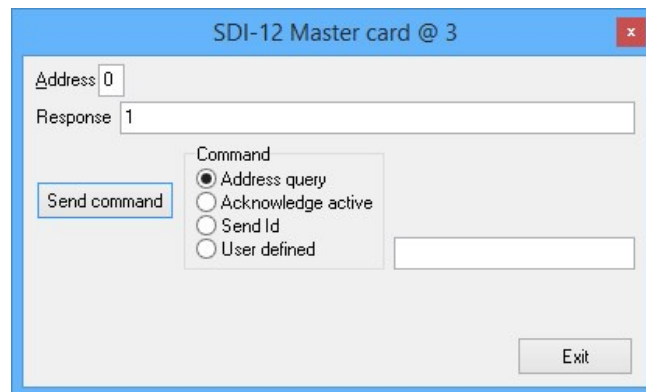

In the example, the sensor has responded to an "Address query" with Address "1".



WARNING: If more than one sensor is connected to the bus, all sensors will respond causing a bus contention.

If multiple sensors are connected to the bus the user must ensure that they have an alternative means of identifying the sensor addresses. For example, each sensor may be connected to the bus individually and the “**Address query**” sent for each. Alternatively, sensor addresses may be added to the “**Address field**” and a “**Send ID**” command performed on each individual address. The user should then note the addresses of each sensor identified.

"Acknowledge active"



WARNING: It is imperative that the correct sensor address be entered into the "Address" field prior to sending this command.

Enter the known address of the sensor you wish to acknowledge in the "Address" field. Click "Send command" and the sensor will respond (if active) with the sensor address in the "Response" field.

The screenshot shows a software window titled "SDI-12 Master card @ 3". It has two input fields: "Address" with the value "1" and "Response" with the value "1". Below these is a "Command" section with four radio buttons: "Address query", "Acknowledge active" (which is selected), "Send Id", and "User defined". To the left of the Command section is a "Send command" button, and to the right is an empty text input field. At the bottom right is an "Exit" button.

In the example, the sensor on Address "1" has responded to an "Acknowledge active".

"Send ID"



WARNING: It is imperative that the correct sensor address be entered into the "Address" field prior to sending this command.

Enter the known address of the sensor you wish to identify in the "Address" field. Click "Send command" and the sensor will respond (if active) with the sensor's identification string in the "Response" field.

The screenshot shows the same software window as above. The "Address" field still contains "1", but the "Response" field now contains the string "113SensorGenericV12123456". The "Command" menu is open, and "Send Id" is now the selected option. The "Send command" button remains highlighted.

*In the example, the sensor on Address "1" has responded with the sensor's identification string:
113SensorGenericV12123456*

"User defined"



WARNING: It is imperative that the correct sensor address be entered into the "Address" field prior to sending this command.

Enter the known address of the sensor you wish to command in the "Address" field. Enter a valid SDI-12 command into the text field and click "Send command". The sensor will respond (if active) in the "Response" field.

Example 1 - The "C" command

The screenshot shows a software window titled "SDI-12 Master card @ 3". It has several input fields and a set of radio buttons. The "Address" field contains the number "1". The "Response" field contains the text "101504". The "Command" section has four radio buttons: "Address query", "Acknowledge active", "Send Id", and "User defined". The "User defined" radio button is selected. To the right of these radio buttons is a text field containing the letter "C". There is a "Send command" button on the left and an "Exit" button at the bottom right.

In the example, the sensor on Address "1" of the SDI-12 bus has responded to a "C" command with the Response "101504".

The 1st digit is the Address identifier (1). The 2nd, 3rd and 4th digits are the time the sensor requires to take a measurement (015 seconds). The 5th and 6th digits are the number of measurement values that will be sent (04).



WARNING: The user MUST ensure that the time required for the sensor to take a measurement is noted BEFORE adding [Add a new "SDI-12" input type](#).

Example 2 - The "R0" command

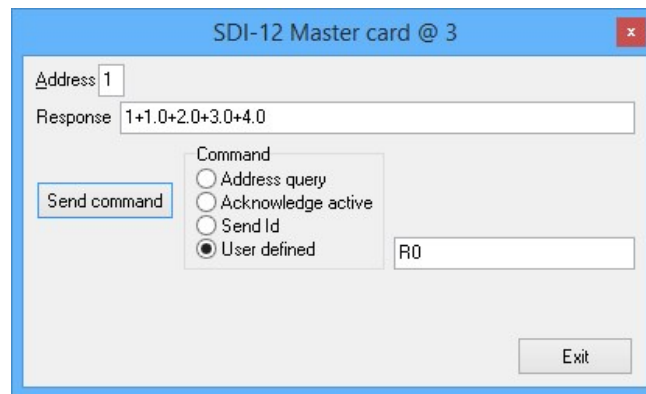

In the 2nd example, the sensor on Address "1" of the SDI-12 bus has responded to a "R0" command with the Response "1+1.0+2.0+3.0+4.0".

The 1st digit is the Address identifier (1). The four measurement values with a polarity sign (+/-) follow.



WARNING: The user **MUST** ensure the position of the measurement values in the string are noted **BEFORE** adding "[Add a new "SDI-12" input type](#)". In the string the measurement after the address identifier is called "*Value number 1*".

Calibrate - Flowrate (using pulse) function

The MACE FloSeries3 Pulse card is used to calculate a flow rate based upon the number of pulses received over a period of time. The Pulse card "**K-factor**", scales the pulses to the required flow rate units.

There are two ways to do this:

- If you have a pulsing flow meter with a published pulse output, you can calculate a "**K-factor**".
- If you have a pulsing flow meter with an unknown "**K-factor**", you can use the "**Calibrate**" function to calculate it for you.



NOTE: A MACE FloSeries3 Pulse card should not be used for "counting" "totaliser pulses. For that application, a MACE FloSeries3 I/O card should be used with an "**Add a new "Input pulse total" channel type**".

Calculate a "K-factor"

Metric Example:

Most pulsing flow meters, output a *known number of pulses per unit volume*. For example, an insertion-style electromagnetic flowmeter, may output say 5.36 pulses/litre in a DN150 pipe. These pulses do not constitute a "**Flow rate**" since all we know, is how many pulses are sent for a litre of liquid that passes through the pipe (5.36). To make these pulses a flow rate, they must be counted over a period of time and multiplied by a "**K-factor**" to give *volume per unit time*.

The "known" "**meter pulses/unit volume**" must be converted to the required flow rate units and timebase for use by the FloSeries3 Pulse card, using the following method:

1. The meter k-factor is published as pulses per unit volume (eg. pulses per litre). This must be converted to unit volume per pulse by inverting the published k-factor.

$$1 \div 5.36 = 0.18636 \text{ litres per pulse}$$

2. Convert the inverted k-factor to the correct timebase to be used in the flow rate calculation.

- **Multiply by 1 for seconds**
- **Multiply by 60 for minutes**
- **Multiply by 3600 for hours**
- **Multiply by 86400 for days**

eg. If the required flow rate units are in L/hr (litres per hour) multiply the inverted k-factor by 3600

$$0.18636 \times 3600 = 670.896$$

3. Enter the newly calculated k-factor in to the k-factor field of the "**Edit channel**" dialogue box and click "**Apply**" to save the settings.

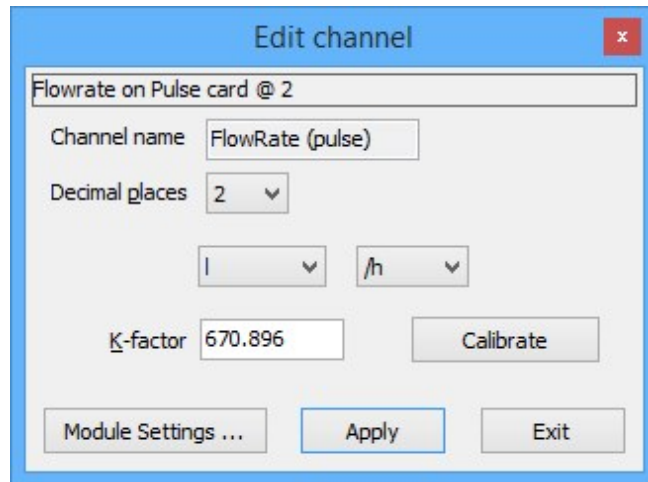

US Example:

Most pulsing flow meters, output a *known number of pulses per unit volume*. For example, an insertion-style electromagnetic flowmeter, may output say 20.31 pulses/gallon in a 6" pipe. These pulses do not constitute a "**Flow rate**" since all we know, is how many pulses are sent for a gallon of liquid that passes through the pipe (20.31). To make these pulses a flow rate, they must be counted over a period of time and multiplied by a "**K-factor**" to give *volume per unit time*.

The "known" "**meter pulses/unit volume**" must be converted to the required flow rate units and timebase for use by the FloSeries3 Pulse card, using the following method:

1. The meter k-factor is published as pulses per unit volume (eg. pulses per gallon). This must be converted to unit volume per pulse by inverting the published k-factor.

$$1 \div 20.31 = 0.049236 \text{ gallons per pulse}$$

2. Convert the inverted k-factor to the correct timebase to be used in the flow rate calculation.

- **Multiply by 1 for seconds**
- **Multiply by 60 for minutes**
- **Multiply by 3600 for hours**
- **Multiply by 86400 for days**

eg. If the required flow rate units are in gal/min (gallons per minute) multiply the inverted k-factor by 60

$$0.049236 \times 60 = 2.9542$$

3. Enter the newly calculated k-factor in to the k-factor field of the “**Edit channel**” dialogue box and click “**Apply**” to save the settings.

The screenshot shows the 'Edit channel' dialog box with the following settings:

- Channel name: FlowRate (pulse)
- Decimal places: 2
- Units: gal /min
- K-factor: 2.9542
- Buttons: Calibrate, Apply, Exit

Calibrate function:

The screenshot shows the 'Edit channel' dialog box with the following settings:

- Channel name: FlowRate (pulse)
- Decimal places: 2
- Units: l /s
- K-factor: 0.18636
- Buttons: Calibrate, Apply, Exit



WARNING: Always use a high quality, accurate and preferably calibrated flow meter as your primary source of “known” flow rate.

1. Click “**Calibrate**” from the “**Edit channel**” dialogue box and the “**Calibrate channel**” dialogue box will appear.

Current pulse rate

The number of pulses per second currently being received by the “**Pulse input**”.

Current scaled value

The current pulse rate multiplied by the current “**K-factor**”.

New scaled value

The current flow rate value in the configured "**Flowrate units**" is entered here.

2. With the sensor connected to the Pulse card, a steady stream flow in the pipe should be obtained. Over a number of minutes, the "**Current pulse rate**" should stabilise.
3. Once the "**Current pulse rate**" has stabilised, enter the actual flow rate value in the "**Flowrate units**" configured into the "**New scaled value**" field. Click "**Accept**" and the XCi device will calculate the new "**K-factor**" to apply to incoming pulses.

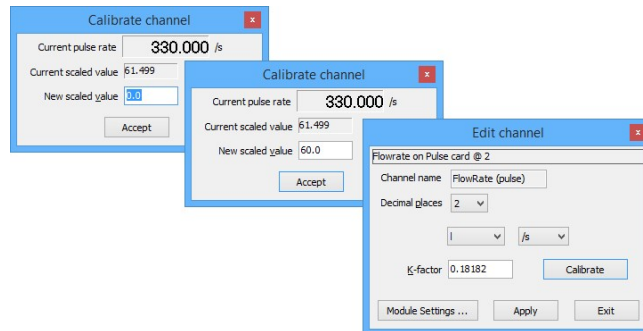

"4-20mA" - output type

This output type is used to send data to ancillary devices that can be proportional to a 4-20mA current. For example, velocity or flow rate data may be sent to a SCADA system.

From the "**Device settings**" dialogue box, click "**Configure outputs**" and the "**Configure outputs**" dialogue will open

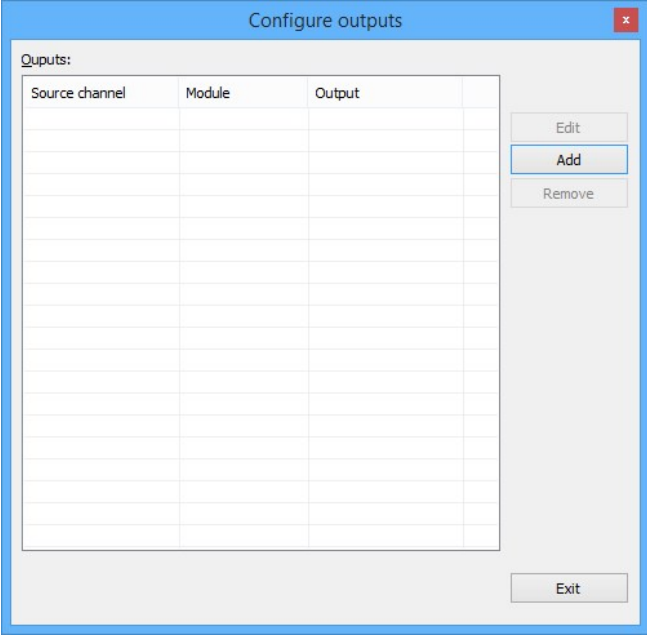

Add a new "4-20mA" output

1. From the "**Configure channels**" dialogue click "**Add**" and the "**Select output type**" box will open.
2. Select "**4..20mA out**" and click "**Continue**".
3. Select the appropriate *physically wired output* from which the output will send its 4-20mA current and click "**Continue**".
4. Select the "**Source channel**" from the drop down list that you wish to output and click "**Continue**".

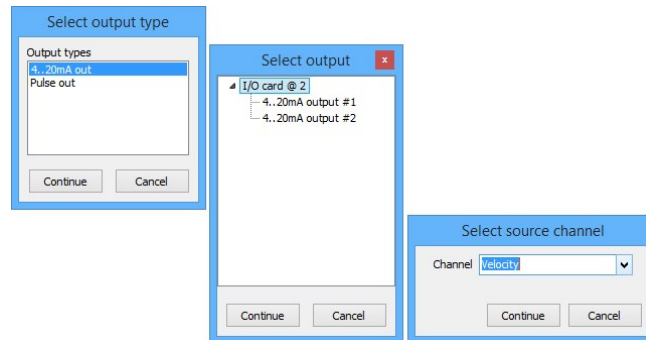

NOTE: Only channels that are suitable for outputting as a 4-20mA proportional current will be available for selection.

Edit a "4-20mA" output

From the "**Configure outputs**" dialogue box, highlight the output you wish to edit and then click "**Edit**".

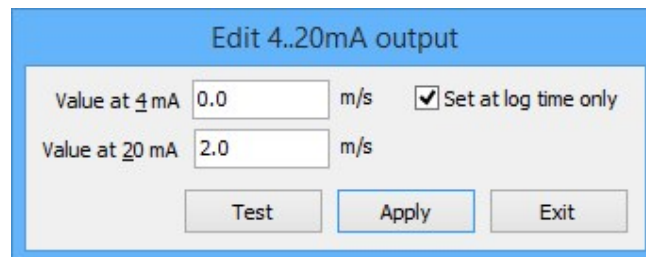

Value at 4mA

The value of the "Source" channel at which the "4-20mA output" will be set to 4mA.

Value at 20mA

The value of the "Source" channel at which the "4-20mA output" will be set to 20mA.

Set at log time only

The user can elect to output an averaged value on the "4-20mA output" by checking the box. When checked, the "4-20mA output" will only be updated at the logging interval otherwise it is updated at each measurement interval. In the case of the measurement interval being shorter than the logging interval, then the "4-20mA output" will be the average of those values calculated per measurement interval.

Click "Apply" to save the settings then click "Exit" to return to the "Configure outputs" dialogue box.

Test a "4-20mA" output

From the "Edit 4..20mA output" dialogue box, click "Test".

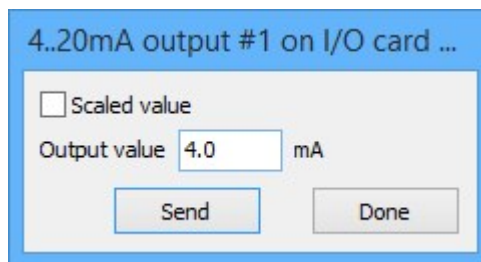

4..20mA output #1 on I/O card ...

Scaled value

Output value mA

1. Enter the "Output value" that you wish to send to the connected "4-20mA receiving device".
2. Click "Send" and the set "Output value" will be sent.

Alternatively:

From the "Edit 4..20mA output" dialogue box, click "Test".

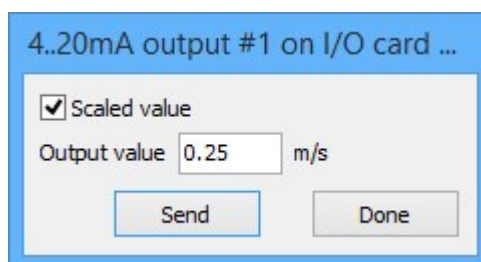

4..20mA output #1 on I/O card ...

Scaled value

Output value m/s

1. Check the "Scaled value" checkbox and the "Output value" will change to output the current proportional to the "Channel value". In this example, "Velocity".

2. Enter the "**Output value**" that you wish to send to the connected "**4-20mA receiving device**".
3. Click "**Send**" and the set "**Output value**" will be sent.

Remove a "4-20mA" output

1. From the "**Configure outputs**" dialogue box, highlight the output you wish to remove and then click "**Remove**".
2. You will be prompted to confirm the removal. Click "**Yes**" and the output will be removed.

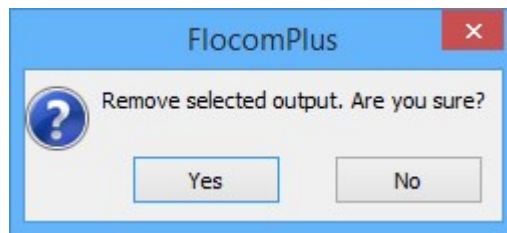

"4-20mA" - output type

This output type is used to send data to ancillary devices that can be proportional to a 4-20mA current. For example, velocity or flow rate data may be sent to a SCADA system.

From the "**Device settings**" dialogue box, click "**Configure outputs**" and the "**Configure outputs**" dialogue will open

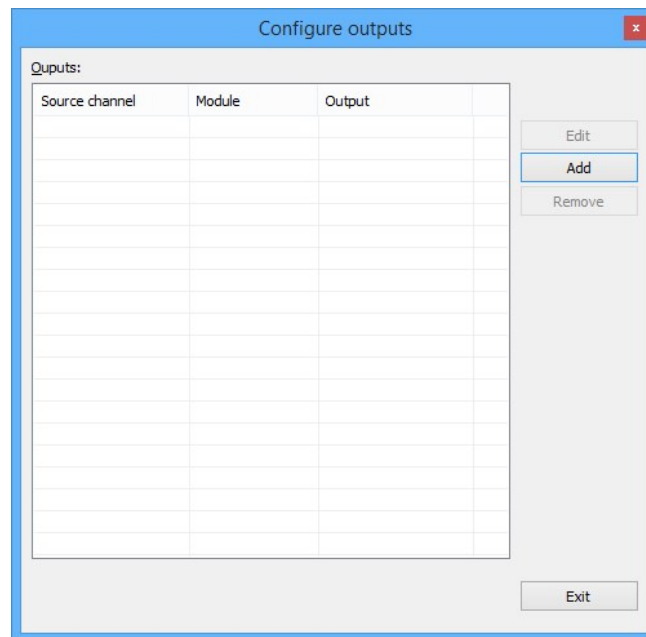

Add a new "4-20mA" output

1. From the "**Configure channels**" dialogue click "**Add**" and the "**Select output type**" box will open.
2. Select "**4..20mA out**" and click "**Continue**".
3. Select the appropriate *physically wired output* from which the output will send its 4-20mA current and click "**Continue**".
4. Select the "**Source channel**" from the drop down list that you wish to output and click "**Continue**".

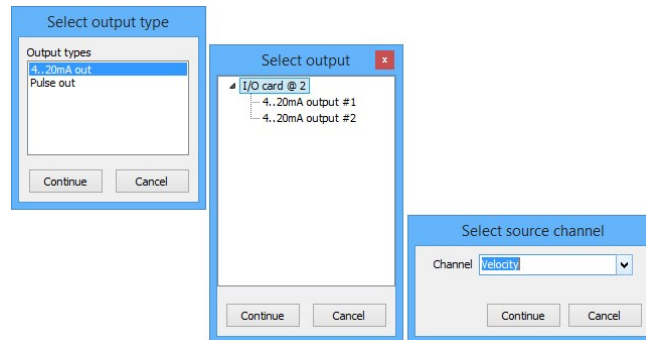

NOTE: Only channels that are suitable for outputting as a 4-20mA proportional current will be available for selection.

Edit a "4-20mA" output

From the "**Configure outputs**" dialogue box, highlight the output you wish to edit and then click "**Edit**".

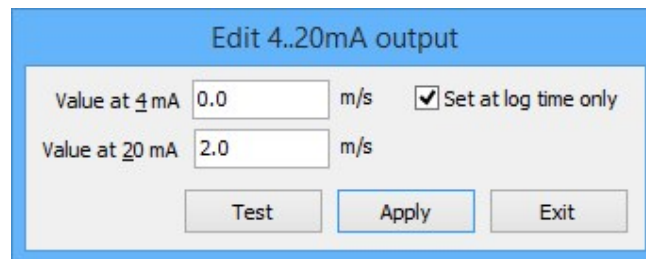

Value at 4mA

The value of the "Source" channel at which the "4-20mA output" will be set to 4mA.

Value at 20mA

The value of the "Source" channel at which the "4-20mA output" will be set to 20mA.

Set at log time only

The user can elect to output an averaged value on the "4-20mA output" by checking the box. When checked, the "4-20mA output" will only be updated at the logging interval otherwise it is updated at each measurement interval. In the case of the measurement interval being shorter than the logging interval, then the "4-20mA output" will be the average of those values calculated per measurement interval.

Click "Apply" to save the settings then click "Exit" to return to the "Configure outputs" dialogue box.

Test a "4-20mA" output

From the "Edit 4..20mA output" dialogue box, click "Test".

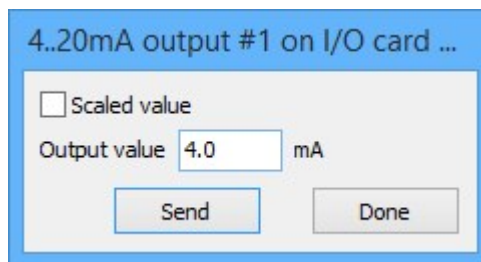

4..20mA output #1 on I/O card ...

Scaled value

Output value mA

1. Enter the "Output value" that you wish to send to the connected "4-20mA receiving device".
2. Click "Send" and the set "Output value" will be sent.

Alternatively:

From the "Edit 4..20mA output" dialogue box, click "Test".

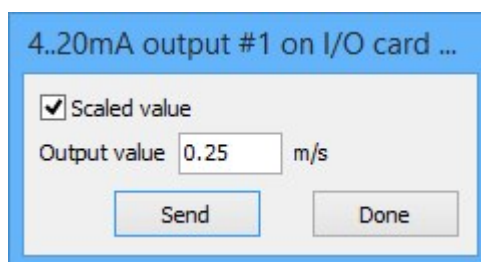

4..20mA output #1 on I/O card ...

Scaled value

Output value m/s

1. Check the "Scaled value" checkbox and the "Output value" will change to output the current proportional to the "Channel value". In this example, "Velocity".

2. Enter the "**Output value**" that you wish to send to the connected "**4-20mA receiving device**".
3. Click "**Send**" and the set "**Output value**" will be sent.

Remove a "4-20mA" output

1. From the "**Configure outputs**" dialogue box, highlight the output you wish to remove and then click "**Remove**".
2. You will be prompted to confirm the removal. Click "**Yes**" and the output will be removed.

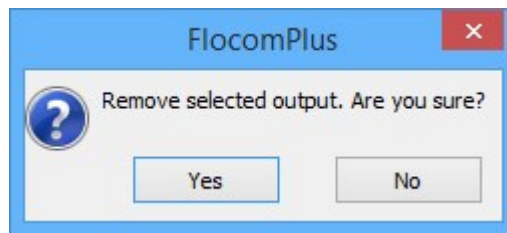

"Pulse" - output type

This output type is primarily used to send "totaliser" pulses to ancillary devices. For example, a pulse may be sent whenever one (1) MegaLitre of water passes through a pipe.

From the "**Device settings**" dialogue box, click "**Configure outputs**" and the "**Configure outputs**" dialogue will open

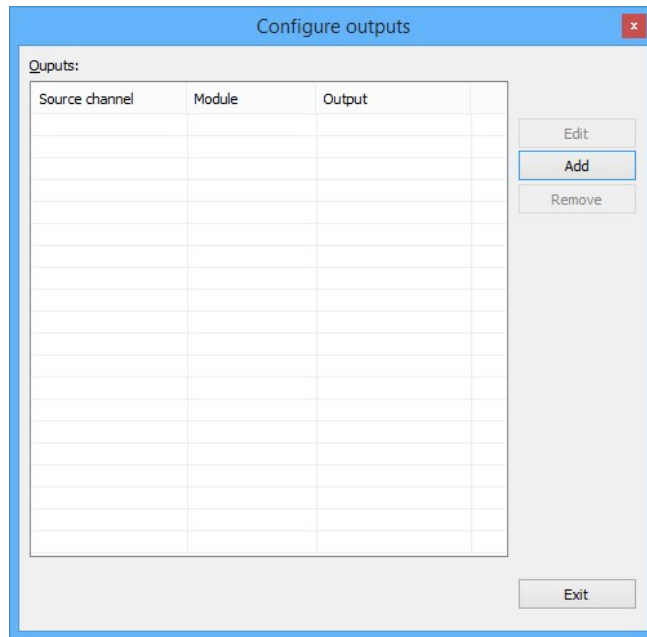

Add a new "Pulse" output

1. From the "**Configure channels**" dialogue click "**Add**" and the "**Select output type**" box will open.
2. Select "**Pulse out**" and click "**Continue**".
3. Select the appropriate *physically wired output* from which the output will send its pulse and click "**Continue**".
4. Select the "**Source channel**" from the drop down list that you wish to output and click "**Continue**".

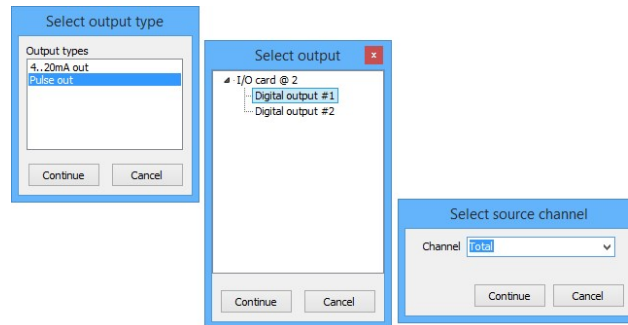

NOTE: Only channels that are suitable for "Pulse" outputting will be available for selection.



NOTE: The MACE FloSeries3 Pulse I/O card, only has a single pulse output.

Edit a "Pulse" output

From the "**Configure outputs**" dialogue box, highlight the output you wish to edit and then click "**Edit**".

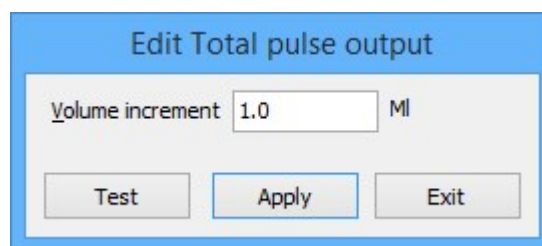

Volume increment

The incremental value at which a pulse will be sent. In the example above, a pulse will be sent whenever an increment of 1 Megalitre is totalised.



WARNING: A maximum of 10 pulses per second may be sent per measurement interval. For example, during a measurement interval of three minutes (180 seconds) a maximum of 1,800 pulses can be sent. If the XCi device has not sent all pulses by the time of the next measurement, pulses **WILL** be lost.

Click "**Apply**" to save the settings then click "**Exit**" to return to the "**Configure outputs**" dialogue box.

Test a "Pulse" output

From the "**Edit Total pulse output**" dialogue box, click "**Test**".

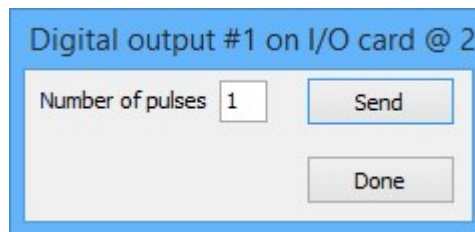

1. Enter the "**Number of pulses**" that you wish to send to the connected "**pulse counting device**".
2. Click "**Send**" and the pulses will be sent.



WARNING: A maximum of 10 pulses per second may be sent per measurement interval. For example, during a measurement interval of three minutes (180 seconds) a maximum of 1,800 pulses can be sent. If the XCi device has not sent all pulses by the time of the next measurement, pulses **WILL** be lost.

Remove a "Pulse" output

1. From the "**Configure outputs**" dialogue box, highlight the output you wish to remove and then click "**Remove**".
2. You will be prompted to confirm the removal. Click "**Yes**" and the output will be removed.

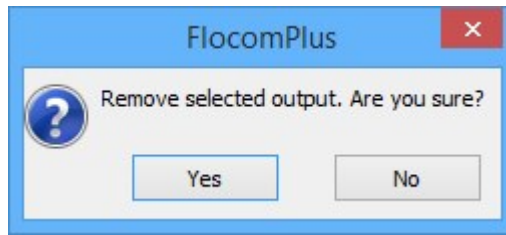

"Binary status" - output type

The "[Channel value level status](#)" and "[Channel value range status](#)" channel types are used in conjunction with a "**Binary status output**" in order to turn pumps (irrigation, dosing, wet-well etc.) and other ancillary devices ON/OFF based on various measured parameter values.



WARNING: The *Binary Status Output* is provided as is, without any guarantees or warranty. MACE makes no warranties of any kind, either express or implied, including but not limited to warranties of merchantability or fitness for a particular purpose. Use of this feature is at the user's risk.



NOTE: The *Binary Status Output* is set to OFF when the XCi device is first "Started", when it is "Stopped" or in a "Flat battery state".

From the "**Device settings**" dialogue box, click "**Configure outputs**" and the "**Configure outputs**" dialogue will open

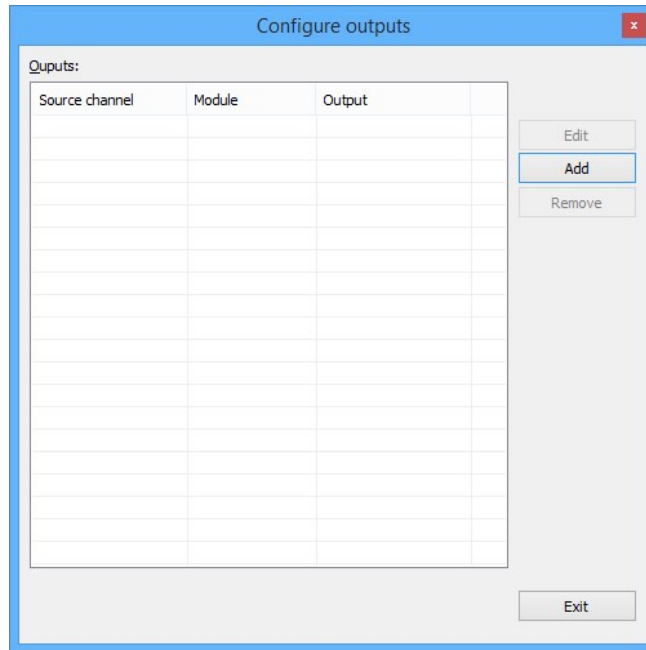

Add a new "Binary status" output

1. From the "**Configure channels**" dialogue click "**Add**" and the "**Select output type**" box will open.
2. Select "**Binary status**" and click "**Continue**".
3. Select the appropriate *physically wired output* from which the output will set its status (ON/OFF) and click "**Continue**".
4. Select the "**Source channel**" from the drop down list that you wish to output and click "**Continue**".

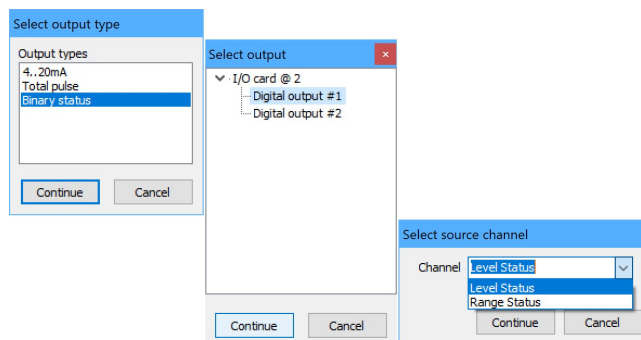

NOTE: Only channels that are suitable for "**Binary status**" outputting will be available for selection.



NOTE: The MACE FloSeries3 Pulse I/O card, only has a single pulse output.

Test a "Binary status" output

1. From the "**Configure outputs**" dialogue box, highlight the output you wish to test and then click "**Edit**". The "Test Binary status output" dialogue will appear.

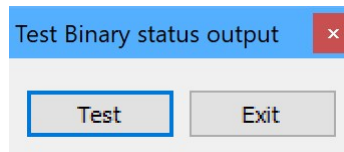

2. Click "**Test**" and the "**Binary status**" will be set to ON
3. Click "**Exit**" to return to the "**Configure outputs**" dialogue box.

Remove a "Binary status" output

1. From the "**Configure outputs**" dialogue box, highlight the output you wish to remove and then click "**Remove**".
2. You will be prompted to confirm the removal. Click "**Yes**" and the output will be removed.

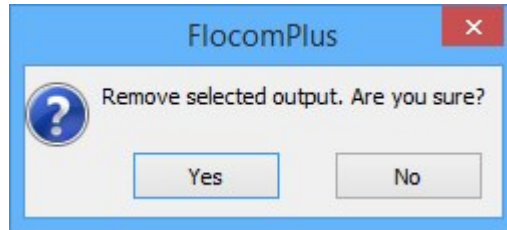

XCi Display and Keypad Usage

The LCD located on the front of the HydroMACE XCi device provides a local readout of the channel parameters that have been [configured to be displayed](#).

The display has a backlight that switches off after a 30 second period of inactivity.

The LCD can be switched on and illuminated simply by pressing either of the keypad "**Up/Down**" buttons. Use the "**Up/Down**" buttons to scroll through each of the parameters.



"Force" a measurement

The HydroMACE XCi device is designed for ultra-low power usage. Part of the way that the device accomplishes this, is to only "wake up" and take a measurement on a [user configurable schedule](#). Under many circumstances, if the XCi device is only going to take a measurement every 15 minutes, it is nice to be able to "force" the device to take a measurement and update the LCD. For example, if a gate or pump is being adjusted, it may be necessary to "force" a measurement to see that adjustment take effect.

1. Momentarily press either of the "**Up/Down**" buttons on the front of the HydroMACE XCi device to "wake up" the LCD.
2. Continue to "toggle" through the channel parameters set up in the device by using the arrow key, until the parameter you are interested in is displayed.
3. Press and hold one button down for three (3) seconds. The LCD will flash the display with the word "**measuring**". The elapsed time of the measurement is dependent upon the [sensor power](#) requirements and/or the sensor integration time.

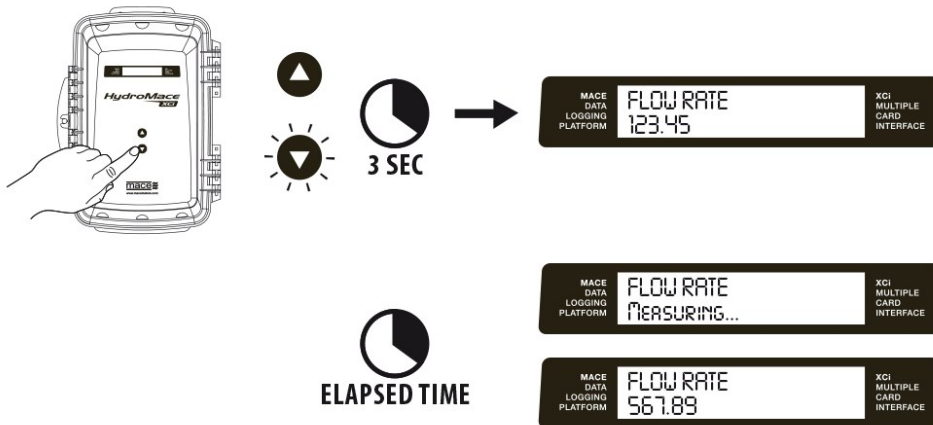

Reset a "Total" with the buttons

Depending upon the device settings, a "**Total**" channel type that has been configured as "[resettable](#)" can be reset using a few simple button presses on the front panel of the HydroMACE XCi device.

1. Momentarily press either of the "**Up/Down**" buttons on the front of the HydroMACE XCi device to "wake up" the LCD.
2. Continue to "toggle" through the channel parameters set up in the device by using the arrow key, until the "**resettable total**" you are interested in is displayed.
3. Press and hold both the "**Up**" and "**Down**" buttons simultaneously for three (3) seconds. After three seconds the question, "**Reset total: Are you sure?**" will be displayed.
4. Confirm the action to reset the totaliser by again pressing and holding both the "**Up**" and "**Down**" buttons simultaneously for three (3) seconds.

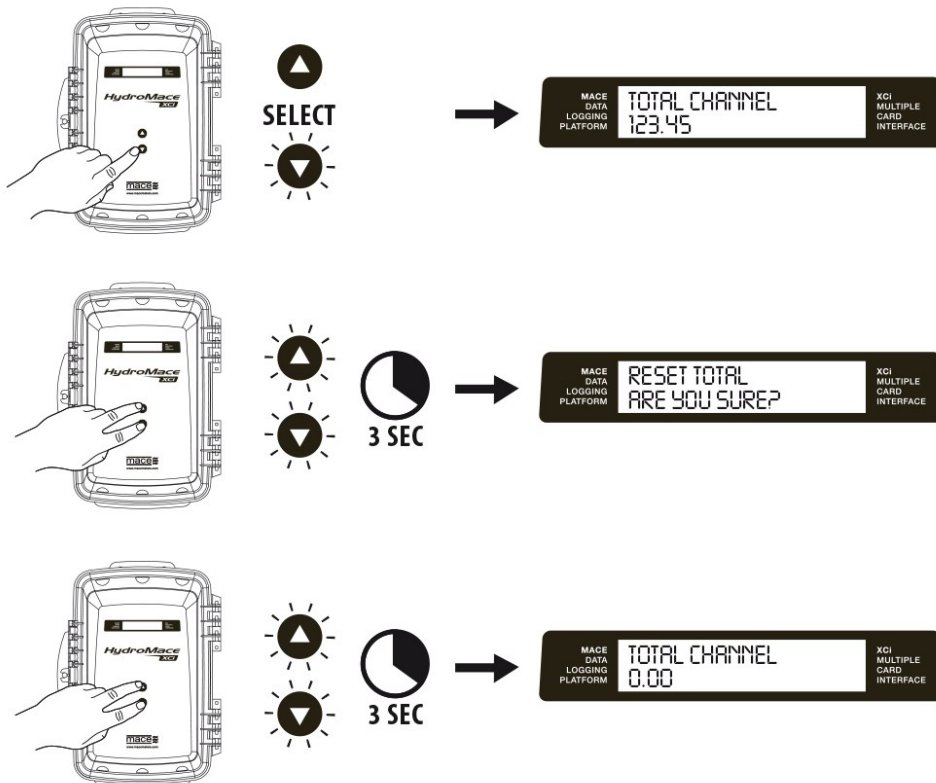

Test the LCD Display

The HydroMACE XCi device provides a facility to test the functionality of the LCD Display.

1. Momentarily press either of the "**Up/Down**" buttons on the front of the HydroMACE XCi device to "wake up" the LCD.
2. Continue to "toggle" through the channel parameters set up in the device by using the arrow key, until "**Test display**" is displayed.
3. Press and hold both the "**Up**" and "**Down**" buttons simultaneously for three (3) seconds. After three seconds, the display will commence scrolling through all possible alphanumeric characters to ensure all LCD segments are operational.
4. At any time, the test function can be terminated by momentarily pressing either the "**Up**" or "**Down**" button.



NOTE: Should any of the LCD characters be missing or damaged, please contact your nearest MACE dealer for repair/replacement.

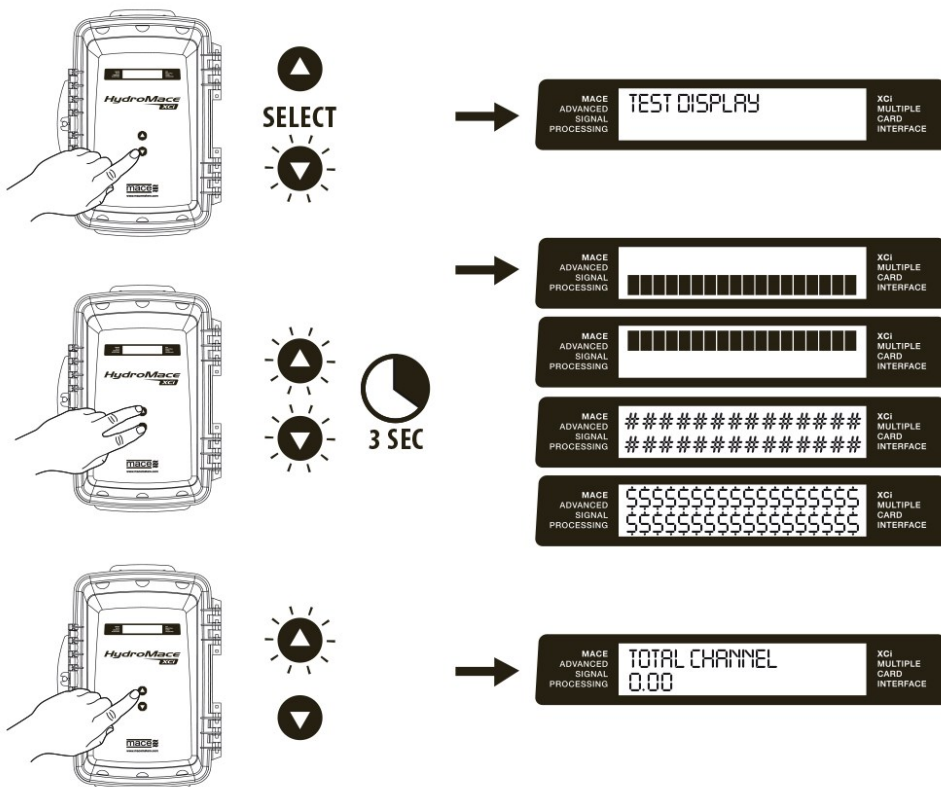

Troubleshooting the XCi



NOTE: This "Troubleshooting Guide" provides a summary of the most common "problems" that users report. Please contact your local MACE representative if you encounter an issue not covered in this guide.



NOTE: If seeking assistance from a local MACE representative for "site" related issues with an XCi device the following files **WILL** be needed:

1. Download device and save data file
2. Save the "Settings" of the device
3. If a Doppler card/sensor is present:
 - a) Run "Doppler sensor check"
 - b) Save at least 10 real-time graphs into an *.mvd file, preferably with both no flow and flow present

These instructions are also on a label inside your XCi device

Email files to your MACE representative.

I can't "Connect" to my XCi with FloCom+

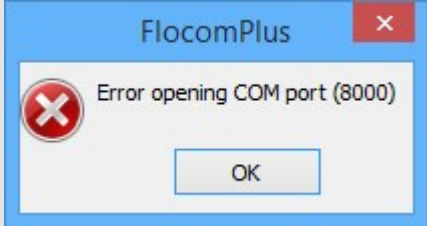
Symptom	Cause	Remedy
	MACE USB comms cable not connected to the XCi device	Plug in cable
	Cable is plugged into a different USB port to that used when cable installed	Try another USB port
	XCi has flat battery	Check battery, replace if necessary
	Sensor (SM) Bus error	Re-initialise XCi device
	Faulty controller card	Return to MACE for service
	MACE USB comms cable not connected to the USB port	Plug cable into USB port of PC
	Cable is plugged into a different USB port to that used when cable installed	Try another USB port
	Driver for USB cable not installed	MACE USB cable driver installation
	Incorrect driver for USB cable	Download/install correct driver

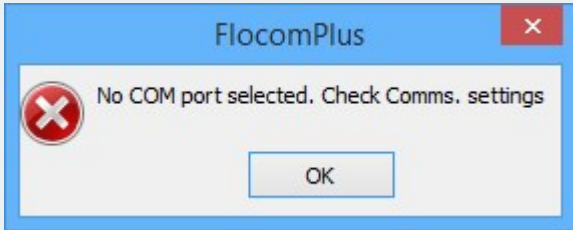
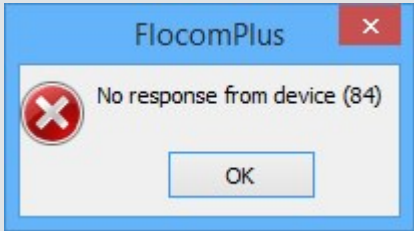
Symptom	Cause	Remedy
	installed	
	USB port of PC inactive	Unplug/replug cable from USB
	MACE cable available but " Always use MACE cable if present " unchecked	Check "Always use MACE cable if present"
	Incorrect password has been used to " Connect "	Check the password or follow the procedure, What to do if the password is lost/forgotten
	No/incorrect comm port selected	Select correct comm port
	No/incorrect comm port selected	Select correct comm port

My XCi has power problems



WARNING: Before troubleshooting power problems, ensure that you've pressed a button on the front of the enclosure to "wake-up" the XCi device. The most common "reason" for a perceived power issue is that the LCD "appears" to be dead.

Symptom	Cause	Remedy
Low/Flat battery (consistently <12 V)	Old battery	Replace battery
	Weak or no solar charge	Check solar panel undamaged
		Check solar panel for dirt and clean if necessary
		Check solar panel is plugged in
		Check wiring of solar panel is correct (polarity)
	No external power	Check trickle charger is plugged in
		Check trickle charger is turned on
		Check wiring of trickle charger is correct (polarity)
	Measurement interval too short	Increase measurement interval
	Integration period too long	Decrease integration period
Too many sensors for power supply	Check the " Power consumption guide "	
None of the above XCi must be drawing high current	Return to MACE for service	

My meter "*Total*" isn't right

Symptom	Cause	Remedy
My meter total "creeps" up	Normally occurs due to moving water - leaky gate, foot valve	Check seals of gates and valves. Consider installing a second gate to isolate the system.
	Entrapped aquatic life in pipe	Adjust "Filters" using FloCom+
	Water "sloshing" in pipe around sensor level	Make sure water level recedes fully, or pipe stays completely full. Consider installing a second gate to isolate the system.
	Electromagnetic interference (EMI) causing false "flow"	Find source of EMI and rectify if possible
My total is not increasing	Total channel set up as " Negative only "	Check " Total " in FloCom+
My total is not decreasing	Total channel set up as " Positive only "	Check " Total " in FloCom+
I can't reset the total	Total channel has been set up as " Non-resettable "	Check " Total " in FloCom+
My total "rolls over" too quickly	Total units are too small for application	Change total_units to larger units
My total is wrong!	Total units are not what's expected	Check total_units in FloCom+
	Total has "rolled over" without me realising it!	

My XCi has problems measuring the depth

Symptom	Cause	Remedy
Depth readings respond slowly to changes in actual depth	Reference filter has not been " Enabled "	" Enable " reference filter
	Reference line has been crimped	Check reference line for crimps
	Sensor cable has been squashed	Look for possible signs of cable compaction
Depth readings seem to be inaccurate	Incorrect units (US only)	Check that units are in your desired ft or in
	Slope/offset incorrectly entered	Check slope/offset entered correctly
	Slope/offset units wrong	Check that slope/offset units are correct off the tag
	Slope/offset calculated incorrectly	Check calculation of slope/offset
Depth does not change	Damaged depth sensor	Check for damage and replace ceramic module
Depth reading is always the offset	Depth sensor not connected properly	Check connection inside XCi
	Damaged depth sensor	Check for damage and replace ceramic module
Depth sensor stays at full-scale	Damaged depth sensor	Check for damage and replace ceramic module

My XCi has problems with the LCD

Symptom	Cause	Remedy
LCD blank	LCD not woken with button press	Press one of the front buttons
	XCi has no power	Check power and rectify
	LCD ribbon cable loose inside XCi	Check ribbon cable
	LCD board faulty	Return to MACE for service
??? on the LCD	Keypad button/s are corroded	Replace front XCi decal
	Sensor (SM) Bus error	Re-initialise XCi device

My XCi has problems when I'm connected to FloCom+

Symptom	Cause	Remedy
Unsupported firmware version	An old version of FloCom+ is being used	Download latest version of FloCom+
Unsupported device function	Firmware version of XCi is older than FloCom+ and you are trying to access new functionality	Update XCi firmware
Card is physically installed in a different Slot# than FloCom+ "thinks"	Error on microprocessor bus	<ol style="list-style-type: none"> 1. "Disconnect" from XCi, remove all power inc. battery and solar panel. 2. Wait 1 min. 3. "Connect".
When connected with FloCom+ there is no date/time displayed in the system area	Corruption in reading clock	<ol style="list-style-type: none"> 1. "Disconnect" from XCi, remove all power inc. battery and solar panel. 2. Wait 1 min. 3. "Connect".
SM bus error	Error on microprocessor bus	Re-initialise XCi device

How to update XCi firmware

From time to time, MACE releases new firmware to enhance functionality and improve product stability/reliability. These new firmware releases are notified by an email sent to "**Registered users**" of the MACE website who have subscribed to the "**Software mailing list**".



NOTE: MACE strongly recommends that users register for Software Updates on the "Support" page of the [MACE Website](#). Releases of product enhancements occur periodically and we recommend that these are uploaded into your XCi device.



NOTE: Depending on the changes to firmware, often a **NEW** version of FloCom+ will **ALSO** need to be [installed](#). You will be informed of this requirement in the email notification.



WARNING: If your device is still running [V1.X.X.X firmware](#) please contact your local MACE representative. You **CANNOT** run this simple firmware procedure.

Prior to upgrading

1. When notified, login to the MACE website, download and save the latest firmware. Ensure you know the location of the saved file.
2. "[Connect](#)" to the device and "[Download](#)" data.
3. "[Stop](#)" device.
4. Click on "[View totals](#)" and write the relevant channel totals down. These may be needed when re-entering the channel information after the upgrade.
5. Click on "**Settings**", then save the device configuration by clicking "**Save settings to file**" and follow the prompts.
6. "**Disconnect**" from FloCom+.



WARNING: **DO NOT** physically disconnect the **USB communications cable** from the device you are upgrading.



NOTE: You are now ready to upgrade the firmware in the HydroMACE XCi device.

Running the upgrade

Locate the program executable you saved "**MACE Flo3 Update XXXXXX.exe**", double-click to "**Run**" and the "**Flo Series3 Updater**" will open.

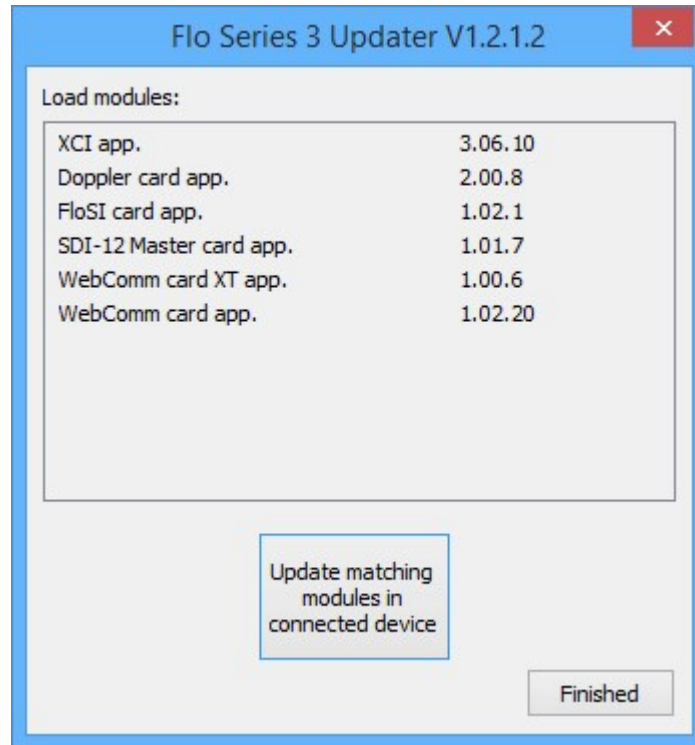

NOTE: The Flo Series3 Updater includes update apps for all field upgradeable FloSeries3 cards. Your system may or may not have applicable cards installed. The updater will only load firmware into cards in your device.

1. Click "**Update matching.....device**" and the matching cards in theHydroMACE XCi device will be upgraded.
2. Where applicable, the XCi system firmware in the "**Controller card**" will be the first to update.You will be asked to confirm your intentions.

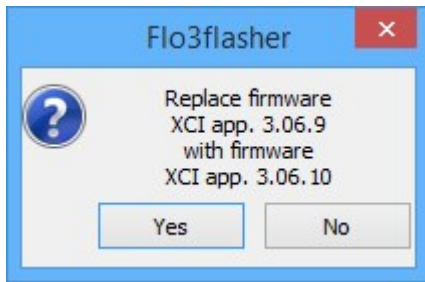

3. If applicable, the other cards will be updated with a similar process. You will be asked to confirm each card update process. Each card update will be run separately. For example, if you have more than one Doppler card, you will be asked to confirm the update process for each card.



4. After all cards have been updated to the firmware versions listed, the program will confirm that the update is complete.

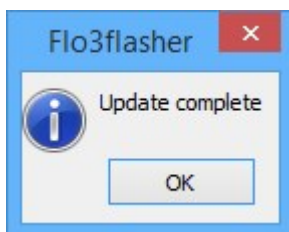

5. You will be returned to the "**Flo Series3 Updater**" dialogue box. Click "**Finished**" to exit from the program.

After the upgrade

1. "**Connect**" to the HydroMACE XCI device with FloCom+.
2. Re-configure your instrument, either by "[Load settings from file](#)" or by completing a new configuration "**Edit settings**".
3. Ensure the system is operational and all sensors are "Calibrated".
4. Click "**View totals**" and re-enter the total values recorded prior to the upgrade (if desired).
5. Click "[Start device](#)" and "Exit" from FloCom+

Battery maintenance

The XCi device's internal battery, if kept fully charged should last many years. However, if the battery remains flat for an extended time, it may be damaged and should be replaced. Contact your vendor for a replacement battery.



NOTE: MACE recommends the main battery is replaced every 5-7 years regardless of *perceived* battery status to ensure system longevity

Removing the old battery

1. Disconnect the battery cable assembly from the backplane board.

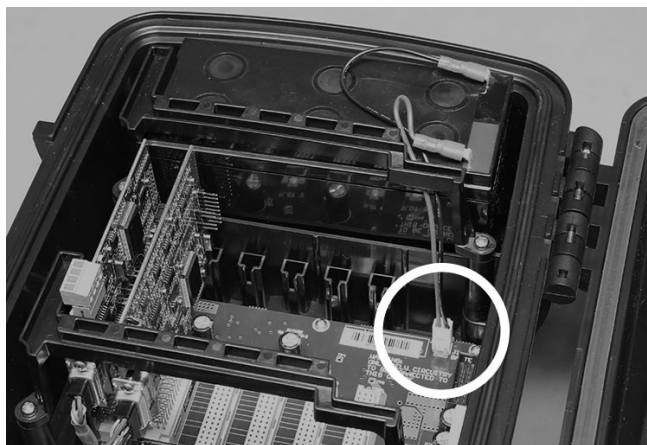

2. Use a #2 Phillips head screwdriver to remove the three screws which fasten the battery bracket to the main enclosure.

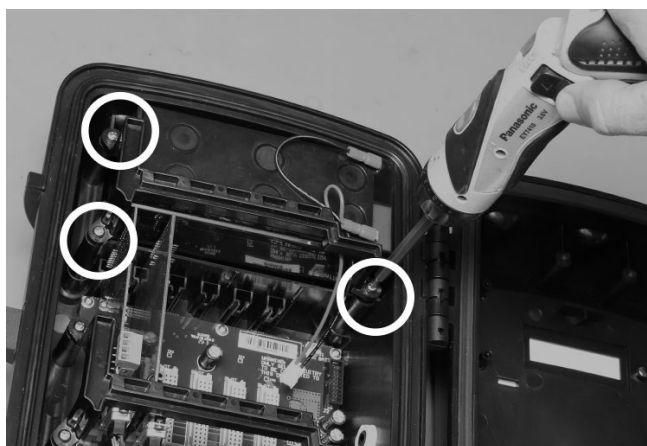

3. Carefully remove the battery from the main enclosure.

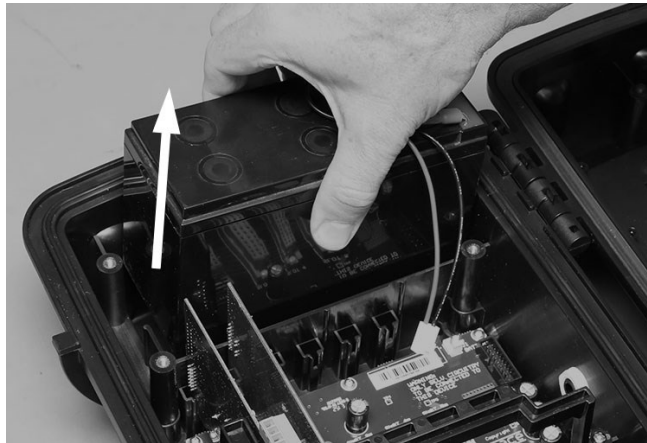

4. Disconnect the battery cable from the battery terminals.

Installing the new battery

1. Connect the battery cable to the new battery, with the red lead to the positive terminal of the battery and the black lead to the negative terminal.

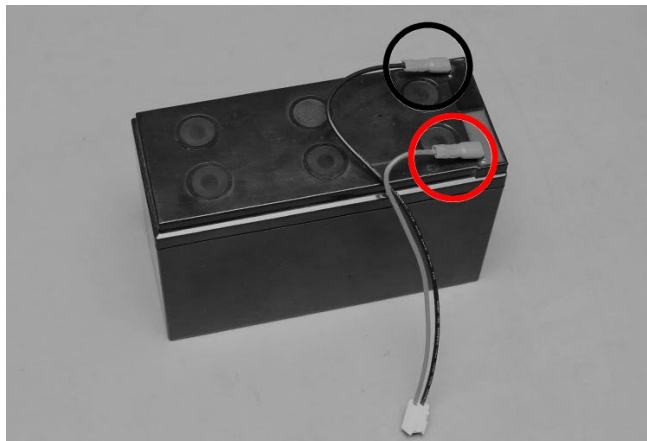

2. Place the battery in the main enclosure and hold it in place.
3. Secure the new battery in place using the battery bracket and three screws.
4. Ensure the battery cable is guided under the bracket as shown.

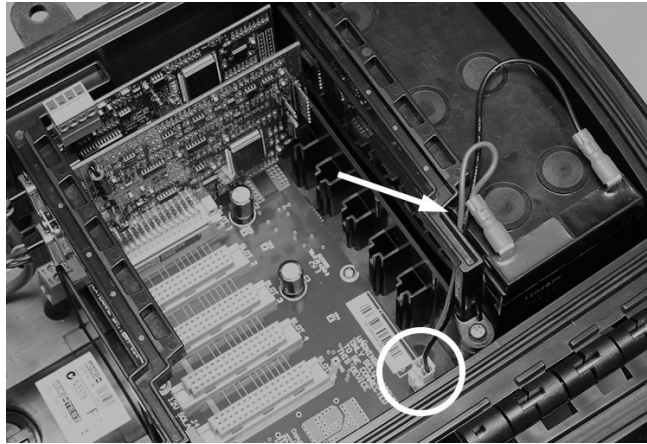

5. Tighten all three screws.
6. Reconnect the battery cable assembly to the backplane board.

Solar panel maintenance

The solar panel should be checked regularly for build up of solids such as dust and bird droppings. These type of build-ups can affect the performance of the solar panel and result in a decrease of the charge that is received by the internal battery.

The solar panel should be cleaned with a wet brush or rag.



WARNING: Do not use steel bristle brushes that may cause damage to the glass of the solar panel

How to store the XCi when not in use

Although the vast majority of installed HydroMACE XCi devices are left "in the field" during periods of non-use, some users choose to remove them to "overwinter".

If removing the device, there are some simple steps to make sure everything will work upon the next installation:

Store the XCi

1. Always "**Stop**" the unit with FloCom+
2. **ALWAYS** leave the main battery connected.. The XCi draws very low current (μA) when "stopped", and the main battery will last at least 6 months.



NOTE: If the XCi is not going to be used for more than 6 months, the XCi device should be put on a 16-30VDC charger periodically to keep the battery charged.

Store the sensor

1. If removing the sensor, ensure that it is stored somewhere where the connector end of the sensor remains dry **AT ALL TIMES**.
2. If you have an area/velocity sensor, "**Disable**" the reference filter by firmly screwing the cap closed.



WARNING: If you intend to leave the sensor in the field without being connected to the XCi device, you **MUST** make the connector end of the sensor waterproof.

MACE USB cable driver installation

1. Under certain circumstances, "**Windows**[®]" may not find the driver for the MACE USB cable (850-363) when it is first plugged in.
2. The following procedure (correct in Windows 8.1) will ensure that the MACE driver is installed:
3. Navigate to the "**Device manager**" in your version of Windows.
4. You will see a tree item called "**Other devices**" where the uninstalled (marked with an ! - mark) USB Serial port is residing.

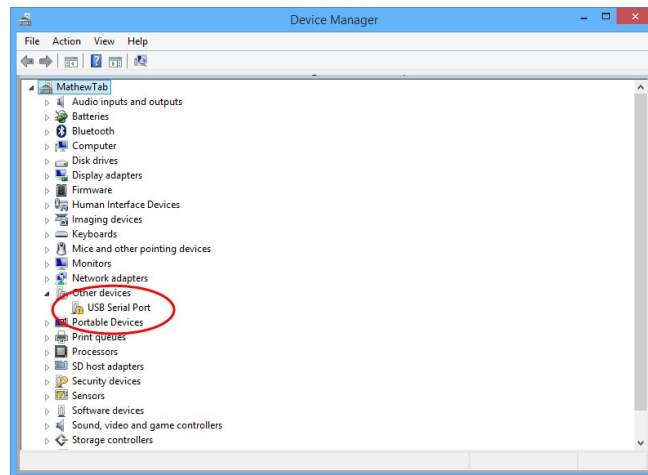

5. Double-click on the "**USB Serial port**" icon and open its "**Properties**" dialogue box. The device status box confirms there are no installed drivers

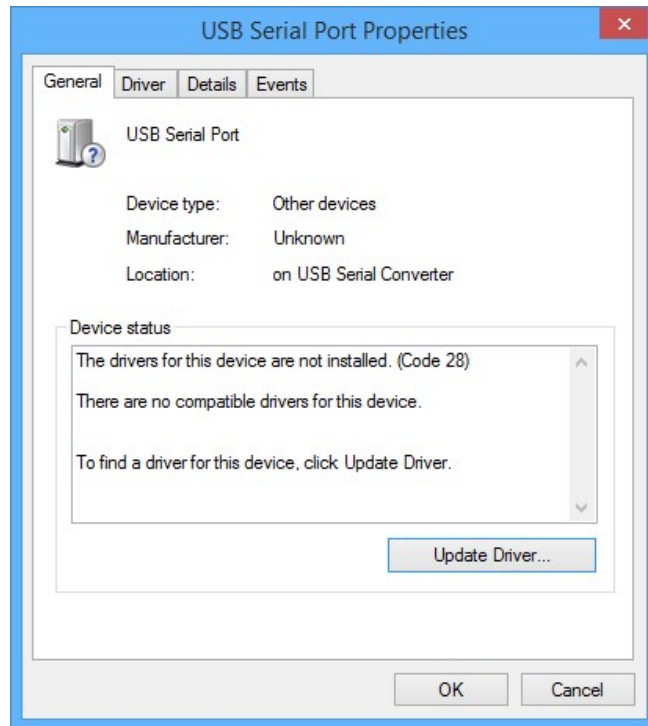

6. Navigate to the MACE Website and "**Run**" the driver setup file

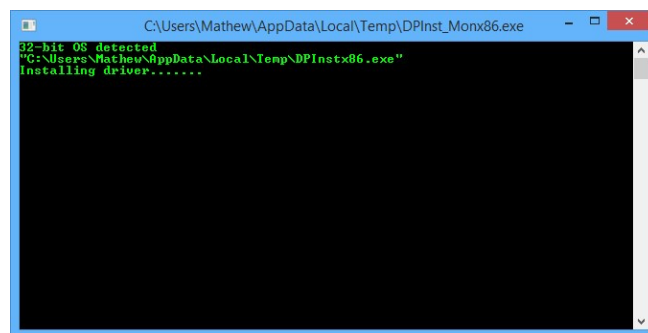
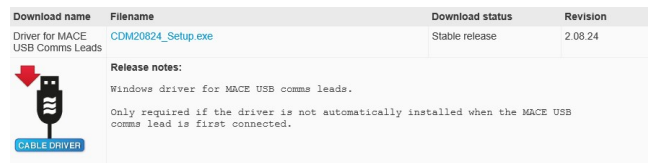

7. Upon completion the USB Serial port properties will show that the device is now installed.

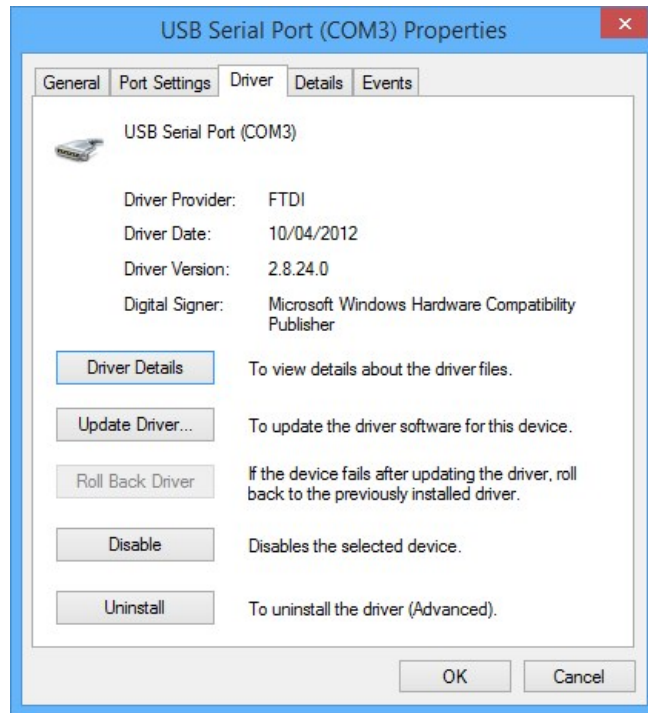

How to re-initialise an XCi

Tools required

- PC running latest version of FloCom+
- MACE USB Communication Cable (Part No. 850-363)
- Phillips screwdriver (#2)

1. "**Connect**" to device with FloCom+ and "**Download data**". "**Stop**" device, then "**Save settings to file**". "**Disconnect**" and shut FloCom+.
2. Disconnect the battery by un-clipping the white connector at "**J1 Battery**".



3. Unscrew the bracket that holds the cards in, using a Phillips #2 screwdriver.

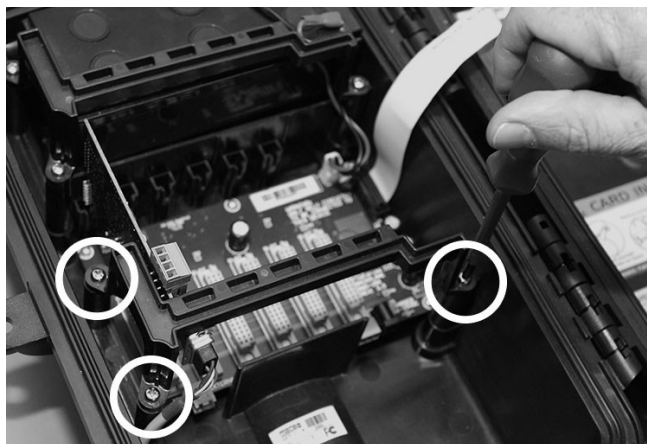



WARNING: Make sure you understand AND follow the "[Installing FloSeries3 Cards](#)" procedure BEFORE the next steps:

4. Remove all cards EXCEPT the Controller card (Slot#0) from the FloSeries3 backplane.



WARNING: You MUST note the Slot# that each individual card was removed from, as they MUST be replaced into the same slots.

5. Wait for at least 1 minute, **This allows the microprocessor on each card to reset.**
6. Re-connect the battery by plugging the white connector back onto "**J1 Battery**". It will only connect one way.
7. Replace each of the cards back into the **SAME** Slot#'s from which they were removed. This should be done one card at a time with at least a 30 second delay between each card.
8. When all cards have been replaced, re-install the bracket that holds in the cards.



WARNING: Take care not to drop screws or touch any of the cards with the screwdriver as damage may occur.

9. "Connect" to device with FloCom+ and "**Set device date/time**" from the "**System**" menu if required.
10. Click "**System**", then "**Card Check**" and ensure that all installed cards are visible. If not, follow the procedure outlined in "[Installing FloSeries3 Cards](#)".
11. Re-configure device if required



NOTE: Depending on the state of the device prior to re-initialisation this may/may not be necessary. If required, "Load setting" from the file you saved in Step 1 above.

MACE product repair procedure

In the unlikely event that your HydroMACE XCi device requires servicing at a MACE facility the following procedure should be followed to ensure efficient service.



WARNING: Due to the potentially hazardous environments in which MACE equipment operates, cleaning PRIOR to sending to a MACE service centre is mandatory so we can ensure the safety of our service technicians. All products used in wastewater applications must be certified clean and free of any potential biological hazards.

1. Note the Serial Number/s and the instrument type of the products that you wish to ship for service.
2. In a manner appropriate to each device, decontaminate all exposed surfaces of Doppler sensors and instrument housings. Seventy (70)% Isopropyl alcohol or a fresh solution of 1:25 (v/v) household bleach:tapwater is suitable for most disinfection. Instruments used with wastewater may be disinfected with a commercially available cleaner such as Lysol® or Pine-o-Cleen® if more convenient.
3. Complete the "**Cleaning Certificate**" ([download here](#)). Make a copy of the certificate and tape it to the outside of the box. The original certificate should be packed with the goods. If cleaning is not performed and/or a "**Cleaning Certificate**" is not returned with the product, MACE reserves the right to withhold service until appropriate cleaning and certification have been completed. We will contact the sender with regards to the disposition of the products.
4. Visit the MACE website and request a "**Returned Goods Number (RG#)**" by filling in the appropriate details in the form.
5. MACE will contact you with an RG#, This MUST be written on the outside of the shipping box and on any documentation being sent.



WARNING: If products are returned to a MACE facility without an RG#, they will not be serviced until such time as the RG# Request form has been completed on the website.

6. Pack the products to be returned in an appropriate manner. MACE instruments are fragile and should be treated as such in any shipping context.



NOTE: Although the lead-acid battery used in XCi devices is certified for air travel, MACE recommends removal of the main battery for return to MACE.

MACE Limited Warranty

1. MACE warrants that any software supplied will perform substantially in accordance with the description and/or accompanying materials for a period of 90 days from date of receipt. MACE warrants that any such software is, as far as it is possible to determine, free from errors, and that should Buyer report any software errors, MACE reserves the right to incorporate the fixes in the next scheduled release of that software product. MACE reserves the right to charge a fee for providing a software updating service.
2. MACE warrants that AgriFlo, FloPro, HVFlo and HydroMace electronics modules supplied shall be rendered free from all defects in materials and workmanship under normal use and service for a period of two years from date of shipment to the end user or three years from the date of manufacture, whichever comes first.
3. MACE warrants that Doppler ultrasonic sensors supplied shall be rendered free from all defects in materials and workmanship under normal use and service for a period of one year from date of shipment to the end user or two years from the date of manufacture, whichever comes first.
4. MACE warrants that all other MACE products supplied shall be rendered free from all defects in materials and workmanship under normal use and service for a period of one year from date of shipment to the end user or two years from the date of manufacture, whichever comes first.
5. Goods that are returned to Buyer following service by an authorised, quality certified, MACE service centre carry a 3-month warranty.
6. Goods that have been tampered with, adjusted, dismantled, or otherwise interfered with will be denied warranty.
7. In no event shall MACE, or its distributor, be liable for any damages whatsoever (including, without limitation, damages for loss of business profits, business interruption, loss of business information, or other pecuniary loss) arising out of the use of, or inability to use any MACE product, even if MACE has been advised of the possibility of damages.
8. Should any Product become defective during the warranty period, and provided that the customer returns the defective Product to MACE for inspection and testing, MACE will, in its sole discretion and at no cost to the customer, repair or replace the defective Product in question.
9. No warranty is included against any expense for removal, re-installation or other consequential damages of any nature arising from any defect.
10. The warranties set out above are the only warranties made by MACE and are expressly in lieu of all other warranties, expressed or implied including the warranties of merchant ability and fitness for a particular purpose.

11. During the warranty period, MACE will pay surface transportation charges both ways (between MACE and the customer) within Australia if the product proves to be defective within 30 days from the date of original shipment to the end user. Throughout the remainder of the warranty period, the customer will pay transportation charges to return the defective product to MACE, and MACE will pay for the surface transportation charges to return the repaired product to the customer. MACE will not pay air freight or packing and crating charges at any time during the warranty period.
12. This warranty does not apply if the Product has been used in a manner contrary to the Products manual or other instructions or has been used in detrimental environmental or other conditions or has been used in a manner likely to cause excessive wear and tear or has otherwise been improperly used or altered in any way.
13. Expendable items such as pump tubing or silica gel satchels are not covered by this warranty.
14. Third party items such as solar panels or trickle chargers are not covered by this warranty but are covered by their manufacturers warranty.
15. All requests for warranty service must be received within the warranty period.
16. This warranty is to the benefit of the original purchaser only and is not transferable on the re-sale of the Product without the expressed written approval of MACE.
17. Subject to any non-excludable contrary provisions of the Australian Trade Practices Act 1974 and corresponding New South Wales State legislation, MACE excludes all terms, conditions, warranties, undertakings, inducements or representations whether express, implied, statutory or otherwise relating in any way to the Product or its use.
18. Subject to any non-excludable contrary provisions of the Australian Trade Practices Act 1974 and corresponding New South Wales State legislation, MACE has no liability to the customer or third party in respect of any loss, consequential or otherwise, damage, injury, claim, demand, cost or expense however caused which may be suffered or which may arise in respect of the supply or use of the Product or in respect of any negligent act or omission of MACE of its servants or agents, or otherwise in connection with the supply or use of the Product or its fitness for a particular purpose. In no event shall the total liability of MACE (howsoever arising) exceed the amount paid by the customer for the Product covered by this warranty.
19. This statement represents the total warranty for MACE products and no person has the authority to alter it.