

PRODUCT MANUAL

HVFlo

XCI



Includes
FloCom⁺
Configuration Software

Table of Contents

Using the HVFlo XCi Manual	11
HVFlo XCi	11
Product Support	12
About Doppler Ultrasonics	13
About MACE	14
WARNINGS	15
Introduction to FloCom+	16
Introducing the HVFlo XCi device	17
Installing an HVFlo XCi	19
Installing the HVFlo XCi enclosure	19
Connecting a MACE Doppler ultrasonic sensor	22
About MACE Doppler sensors	24
True average velocity measurement with MASP Technology	24
MACE Doppler velocity sensor types	25
Selecting a suitable site for Doppler ultrasonic velocity measurement	28
Installing a MACE Doppler ultrasonic insertion sensor	33
Installing a MACE Doppler Area/Velocity sensor	40
Installation with a ZX SnapStrap	40
Installation with a mounting plate	48
Installing a MACE Doppler velocity only sensor	51
Introduction to FloSeries3 cards	52
Installing FloSeries3 Cards	53
About the Doppler Card	57

About the WebComm card	59
Preparing and installing a Webcomm card	60
Add a WebComm site on the web	62
Configure a WebComm card using FloCom+	65
HTTP Upload	66
FTP Upload to In-Situ HydroVu Data Server	68
FTP Upload	69
Edit HydroVu Headers	70
The "WebComm Utility"	74
Test an HTTP Upload	74
Test an FTP Upload	75
Error messages table:	76
Using "AT+ commands" to troubleshoot a WebComm card	78
Initial upload routine:	79
Common AT+ commands	80
Editing/Viewing a WebComm site on the web	83
Site data	83
Download site data	83
Show latest record	84
Delete site data	84
Site details	85
Site Details	85
Site keys	85
Site alarms	86

Site users	86
Remove site	86
Alarm history	87
All about Webcomm SMS/Email alarms	88
Enable alarm usage	88
Alarm configuration	89
Alarm description:	90
Channel to use for this alarm:	90
Send the alarm when the channel value is above/below:	90
Clear the alarm when the channel value is above/below:	90
Add this value to alarm set point each time the alarm occurs:	90
After the alarm has been sent disable it for:	91
Send an SMS message to these phone numbers:	91
Limit SMS message size:	91
Send an email message to these addresses:	91
Message:	92
Alarm state	93
Edit Alarms	94
Alarm history	95
Installing an HVFlo XCi	96
Installing the HVFlo XCi enclosure	96
Connecting a MACE Doppler ultrasonic sensor	99
Introduction to FloCom+	101
Installing FloCom+ Software	102

Connecting to an HVFlo XCi device	105
Remote communications with an XCi device	108
Enable a "Remote Connection" in the WebComm card	108
Run a WebComm "Forced Upload"	108
FloCom+ - The essential steps to configuring an HVFlo XCi device	114
Edit general settings	115
Add XCi channels	117
Edit XCi Channels	119
Ordering, renaming, setting of attributes and removing channels	120
Reset card/configuration	124
The File menu	125
View download file	126
Table of Status messages	127
View MVD file	129
View MDCF file	131
Comms settings	132
The Main Menu	133
Disconnect	134
Download	135
Settings	136
Edit settings	136
View settings	136
Save settings to file	137
Load settings from file	137

Measure and display	139
Doppler sensor check	140
SDI-12 Master utility	140
WebComm utility	140
Start/Stop HVFlo XCi device	141
The System menu	142
Set device date/time:	142
Change download password	143
Change super password	143
System settings	144
Clear stored data	144
Card check	145
View totals	146
Introduction to XCi channel types	148
Add a "Velocity" - channel type	150
Sensor Type:	153
Conduit Type:	153
Sensor type	156
Monitor status	156
Sensor orientation	156
Velocity range	157
Integration period	158
Maximum measurement count	158
Calculation method	159

Velocity peak threshold	161
Correction factor	162
"Sensor settings"	162
Recommended "Velocity" settings for typical Doppler ultrasonic applications	163
So, what are "Slope" and "Offset"?	165
"Depth" channel from a MACE Doppler Sensor	166
"Depth" channel from a MACE EchoFlo Depth Sensor	166
Edit a "Depth" - channel type	168
"Flowrate (using velocity)"- channel type	169
Add a "Flowrate (using velocity)"- channel type	169
Edit a "Flowrate (using velocity)" - In a full pipe or circular pipe using depth	170
Edit a "Flowrate (using velocity)" - In an open channel	170
Using MACE "FloCalc" to calculate polynomial coefficients	171
Add a "Flowrate (using velocity)"- channel type	174
Edit a "Flowrate (using velocity)" - In a full pipe or circular pipe using depth	175
Edit a "Flowrate (using velocity)" - In an open channel	175
Using MACE "FloCalc" to calculate polynomial coefficients	176
Add a "Flowrate (using lookup table)" - channel type	179
Edit a "Flowrate (using lookup table) - channel type	179
Add a "Flowrate (using weir)"- channel type	182
Edit a "Flowrate (using weir) - channel type	183
Add a "Flowrate (using trickle flow)" - channel type	185
Edit a "Flowrate (using trickle flow)" - channel type	186
Add a "Total flow" - channel type	192

Edit a "Total flow" - channel type	193
Add a "Velocity (depth corrected)" - channel type	197
Edit a "Velocity (depth corrected)" - channel type	197
Add a "Volume (using lookup table) - channel type	199
Edit a "Volume (using lookup table) - channel type	199
"Device battery voltage" - channel type	202
"Doppler sensor check" and interpreting real-time data	204
So what makes up a "Real-time graph"?	204
Interpreting real-time data	206
"Measure and Display" function	212
"Offset adjust" function	213
"2-Point Calibration" function	214
Troubleshooting the XCi	216
I can't "Connect" to my XCi with FloCom+	217
My XCi has power problems	219
My meter isn't reading the right flow rate!	220
My meter "Total" isn't right	222
My XCi has problems measuring the depth	223
My XCi has problems measuring velocity	224
My XCi has problems when I'm connected to FloCom+	226
How to update XCi firmware	227
Prior to upgrading	227
Running the upgrade	228
After the upgrade	229

Recharging an HVFlo XCi	230
Battery maintenance	231
Velocity sensor maintenance	234
How to store the XCi when not in use	236
How to replace the depth module in an Area/Velocity sensor	237
Remove the damaged ceramic depth sensor	237
Installing the new ceramic depth sensor	240
Maintaining the HVFlo breather valve	245
MACE USB cable driver installation	248
How to re-initialise an XCi	251
MACE product repair procedure	253
MACE Limited Warranty	254

Using the HVFlo XCi Manual



HVFlo XCi

Portable waterproof logging flowmeter

HVFlo XCi is a high performance battery operated open channel flow monitoring solution for wastewater, stormwater and industrial discharge applications. HVFlo XCi features MACE Doppler ultrasonic velocity sensors utilizing MACE Advanced Signal Processing (MASP) technology that “see” across the entire stream profile to give a true average velocity. MASP allows HVFlo XCi to produce superior results under a very wide range of hydraulic operating conditions.

The HVFlo XCi device typically consists of the following main components:

- The HVFlo XCi device
- The FloSeries3 card/s providing inputs for connecting an array of sensors
- The sensor(s) or peripheral(s)
- The battery charger
- FloCom+ software enabling you to configure and download data from your HVFlo XCi device

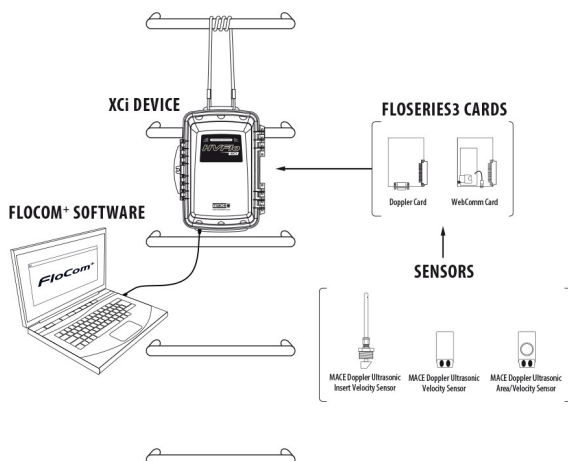

Product Support

Should you experience difficulty in using this product, please contact your local MACE vendor. We also welcome feedback from customers who feel that their experience may provide an improvement to the product or may be beneficial to other users.



NOTE: MACE strongly recommends that users register for Software Updates on the “Support” page of the [MACE Website](#). Releases of product enhancements occur periodically and we recommend that these are uploaded into your XCi device.



NOTE: MACE strongly recommends that users "[subscribe](#)" to the macemeters YouTube channel for video content applicable to installation and maintenance of your XCi system.

Disclaimer

No warranties of any nature are extended by this document. Measuring and Control Equipment Co. Pty. Ltd. (MACE) will not accept any financial or other responsibility that may be the result of your use of this information, including direct, indirect, special or consequential damages.

You must be careful to ensure that the use of this information complies with the laws, rules and regulations of the jurisdictions with respect to which it is used. MACE assumes no responsibility for personal or property damage caused by the misuse of this equipment.

Copyright

Information in this document is subject to change without notice. The software described in this document is furnished under a license agreement or nondisclosure agreement. The software may be used or copied only in accordance with the terms of those agreements. No part of this publication may be reproduced, stored in a retrieval system, or transmitted in any form or any means electronic or mechanical, including photocopying and recording for any purpose other than the purchaser's personal use without the written permission of Measuring & Control Equipment P/L.

Copyright © 1996-2019. MACE P/L. All rights reserved.

Revision number: 19.1

Windows is a registered trademark of Microsoft Corporation in the United States and other countries.

About Doppler Ultrasonics

MACE XCi devices utilise the Doppler Effect to measure velocity of stream flows.

The Doppler Effect (after C. J. Doppler 1803-53) is defined as, “the apparent change in the frequency of sound or electromagnetic radiation due to relative motion between the source and the observer” (Uvarov & Isaacs (1986). Dictionary of Science).

The MACE Doppler ultrasonic velocity sensors transmit an ultrasonic (sound) wave into the flow. This sound wave is reflected by acoustically reflective particles (e.g. air bubbles, suspended solids) and the instrument detects the reflected frequencies. The difference between the transmitted frequency and the received frequencies is directly proportional to the velocity of the stream flow.

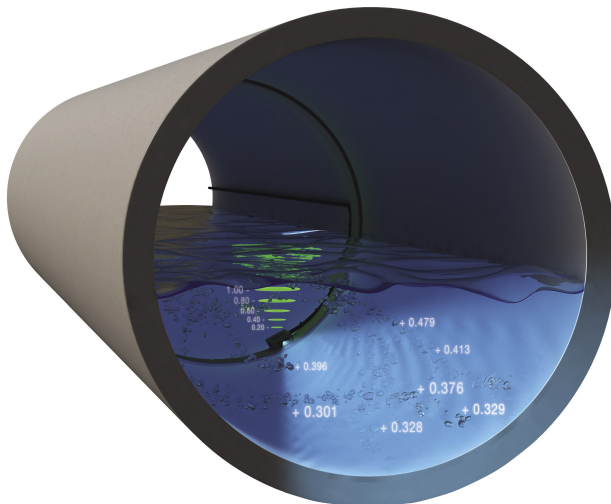
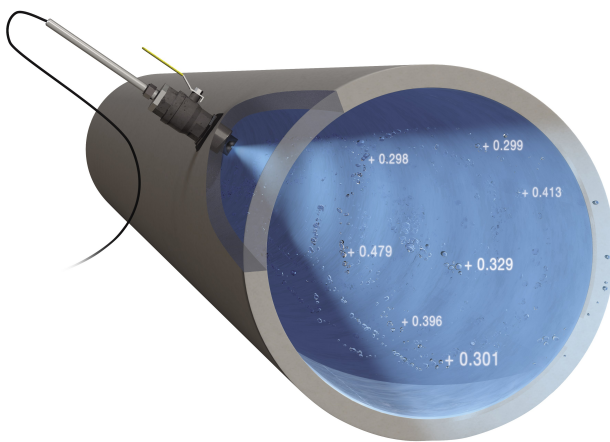

In full or partially full pipes, the velocity of the stream flow varies markedly across the cross-section of the pipe. Typically, velocity is zero along the wall of the pipe and increases to a maximum at or about the centre of the pipe. MACE Doppler ultrasonic velocity sensors receive reflected frequencies from particles moving at these different velocities. The greater the area of flow moving at a particular velocity, the greater the number of reflections with the respective frequency shift. The average velocity of the stream is therefore calculated by averaging those frequency reflections received across the whole stream profile. In layman's terms a simple analogy for the way MACE Doppler ultrasonics operate is that it's similar to “switching on a flash light in a fog”. Any reflective particle that moves within the “beam” will be seen by the ultrasonic sensor. MACE Doppler ultrasonic velocity sensors provide a true average stream velocity.

About MACE

MACE is a company founded in 1968 by electrical and mechanical engineer Lawrence Campbell who recognized the importance of flow measurement and flow monitoring in the global environment.

For over 50 years MACE has designed and manufactured electronic monitoring instrumentation including ultrasonic flow meters, data loggers and controllers. Continued commitment to research and development over the past three decades has ensured MACE's provision of the most advanced high technology equipment for the agricultural, industrial and environmental markets.

MACE has a core team of research and development engineers who are focused on providing customer driven products that are both easy to use and withstand the test of time in often remote and harsh environmental conditions.

MACE is committed to providing its clients with personalized service, training and technical back-up to ensure successful monitoring.

MACE continues to innovate with the introduction of the new XCi Multiple Card Interface found in all our new range of flow meters and data loggers. XCi enables the user to connect just about any environmental sensor quickly and easily. This offers the customer a highly flexible, cost effective water monitoring solution.

With the addition of a new MACE WebComm card to any XCi device, customers are able to access their data remotely for free from the MACE website.



An  **In-Situ** Company

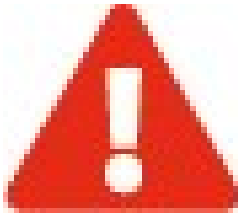

WARNINGS

Cable damage

MACE recommends that all cables be appropriately routed through electrical conduit or other similar mechanism. MACE will not be liable for damage to cables, especially if it is caused by vehicles, digging implements, animals or debris in the pipe or channel.

Battery life

Care must be taken when a mains power supply is used to charge the internal battery instead of a solar panel. If the mains power remains disconnected for an extended period of time, the internal battery may be permanently damaged.

Electromagnetic compatibility (EMC)

This is a Class A product. In a domestic environment this product may cause radio interference in which case the user may be required to take adequate measures.

Intrinsic Safety

The HVFlo XCi device is NOT an intrinsically safe instrument and should not be installed in hazardous (explosive) environments.

Water damage

The Gore-tex breather vent in the HVFlo XCi, MUST be replaced after the device has undergone submersion. Failure to do so may lead to water damage. MACE will not be liable for damage caused by flooding of the device.

Introduction to FloCom⁺

MACE FloCom⁺ is the software that enables you to communicate, configure and download data from your HVFlo XCi device

System Requirements

Minimum system requirements for PC are:

- Windows® XP
- 10Mb available hard drive space
- USB port
- For many of the functions described in this manual FloCom⁺ Version 3.X.X.X



MACE Software End User License Agreement (EULA)

Users should read and accept the terms of the MACE EULA before installing FloCom⁺ on their PC. The EULA can be found on the downloads page of the [MACE website](#).

Introducing the HVFlo XCi device

The HVFlo XCi device is the central processing unit of the system and includes the enclosure, battery, Doppler card and four spare card slots in which the different FloSeries3 cards can be factory installed, depending upon your application.

A communications port is located on the bottom face of the main enclosure. Using a MACE USB data cable (Part No. 850-363) between this port and a PC, users can configure, troubleshoot and download data from the device using the MACE FloCom+ software downloadable from www.macemeters.com.

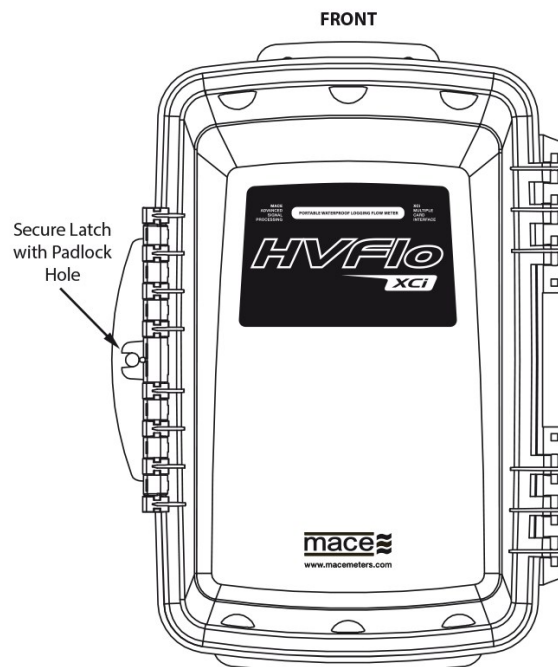

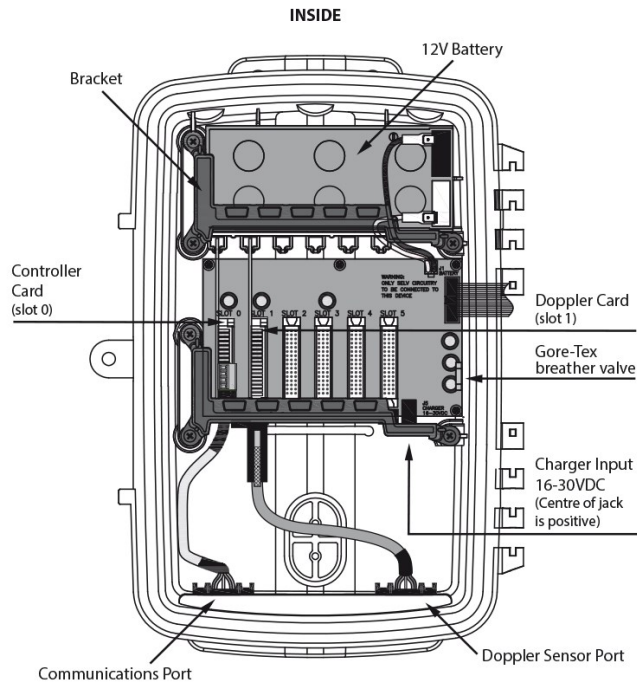

NOTE: Door not shown

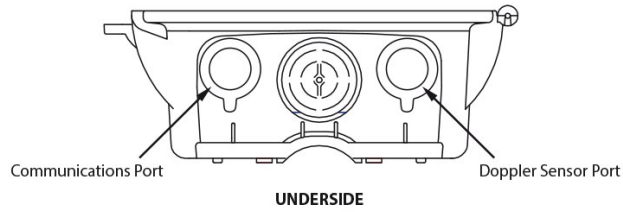

Installing an HVFlo XCi



NOTE: The HVFlo XCi is a waterproof logging flow meter. It has an International Protection (IP) rating of 68 for submergence to a maximum of 3m (10ft). MACE highly recommends that the HVFlo XCi is mounted in an area above known flood levels wherever possible to avoid damage by water ingress.

Installing the HVFlo XCi enclosure

1. The HVFlo XCi should typically be mounted on a railing or ladder-rung using the HVFlo XCi mounting strap (850-407).
2. Locate the HVFlo mounting strap that was supplied with the HVFlo XCi.
3. Open the "**snap-hook**" on one end of the strap.



4. Insert the open end through the mounting hole located on the top of the XCi device and let it "snap" shut



5. Wrap the strap multiple times around the railing or ladder rung.
6. Open the "snap hook" on the free end of the mounting strap.
7. Insert the open end through the mounting hole adjacent to the one to which the other end of the mounting strap is attached and let it "snap" shut.



WARNING: DO NOT put undue weight on the strap (>10kg/22lb). Avoid eye injury. DO NOT overstretch. ALWAYS keep face and body out of recoil path. DO NOT use when strap has visible signs of wear or damage.

9. Let the HVFlo XCi hang loosely.



Connecting a MACE Doppler ultrasonic sensor

1. Unscrew the cap from the Doppler sensor port on the right underside of the HVFlo XCi enclosure.



2. Unscrew the Doppler sensor connector cover off the sensor you wish to plug into the HVFlo XCi



3. Plug the sensor into the sensor port, and screw the retaining ring firmly into place.



WARNING: Ensure that the retaining ring is **NOT** cross-threaded as this **WILL** lead to the HVFlo not maintaining its waterproof rating.

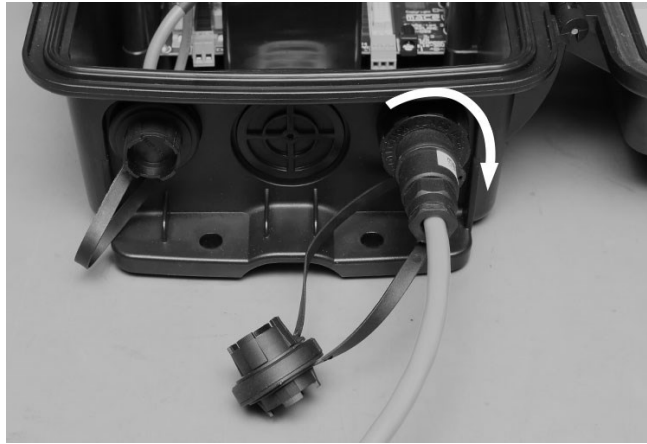

4. Screw the sensor port cap and the sensor connector cover together as shown in the photo above. This will ensure that debris does not enter the threaded section of either cap/cover.

About MACE Doppler sensors

True average velocity measurement with MASP Technology

MACE velocity sensors use continuous wave Doppler ultrasound to measure the speed of dirt, bubbles and other particles in the stream flow.

MACE Doppler ultrasonic sensors “see” particles in water like turning on a flashlight in fog.

In a full pipe, electromagnetic or mechanical insertion devices “see” a golf ball sized velocity profile and then use complex algorithms to calculate velocity. By contrast, MACE Doppler ultrasonic velocity sensors utilizing MACE Advanced Signal Processing (MASP) technology “see” across the entire stream profile to give a true average velocity

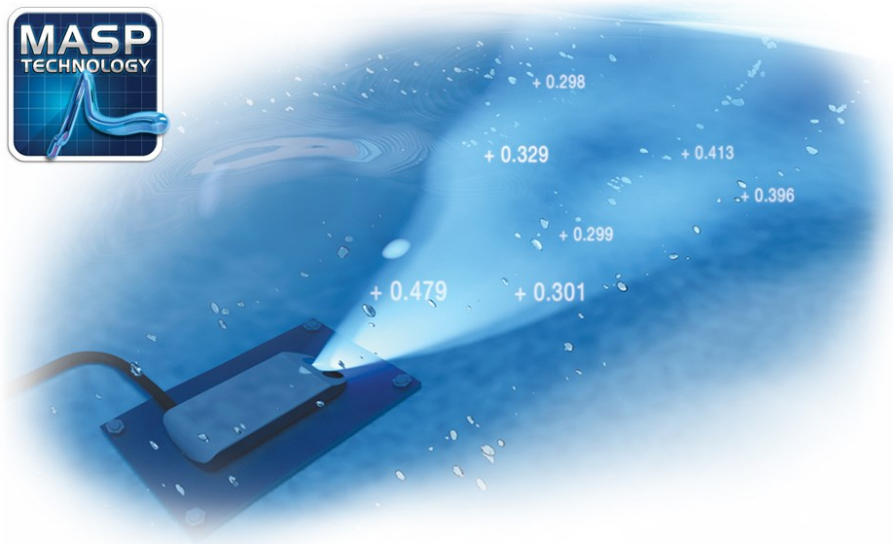

MACE Doppler velocity sensor types

MACE designs and manufactures Doppler ultrasonic velocity sensors for use in full-pipes, partially-full pipes and open channels. MACE manufactures three different style of sensor to enable easy installation in a wide variety of applications. Our Doppler ultrasonic velocity sensors with MASP technology and no moving parts are easy to install and virtually maintenance free.

MACE Doppler ultrasonic insert velocity sensor



This type of sensor is used in full pipes where access into the pipe is impractical or when it may be necessary to remove the sensor in the future without stopping the flow or emptying the pipe.

Insertion sensors require access to the outside wall of the pipe in which the sensor is to be mounted. The 2" insertion sensor should be used in pipes that have a diameter of greater than 100 mm (4").



NOTE: MACE recommends that a ball or gate valve is always used when installing insertion sensors so that sensor maintenance can occur without requiring the pipe to be emptied of liquid.

The MACE Doppler ultrasonic velocity insert sensor is connected to a [FloSeries3 Doppler card](#).

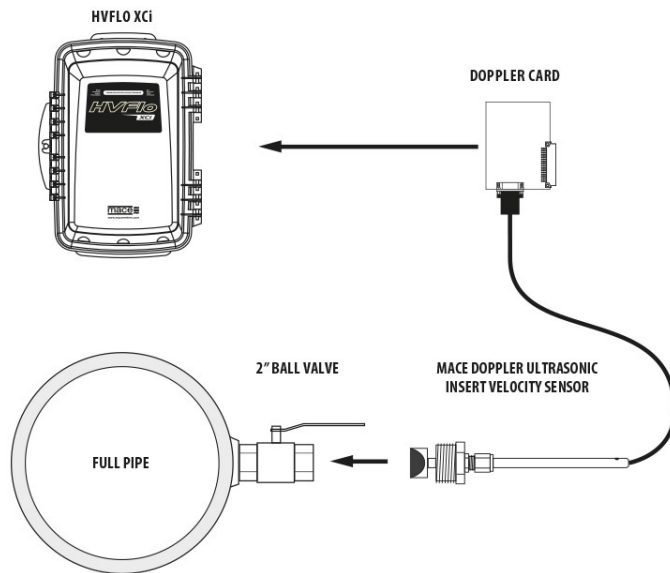

MACE Doppler ultrasonic strap mount velocity sensors

ZX SnapStrap mounted velocity only sensor

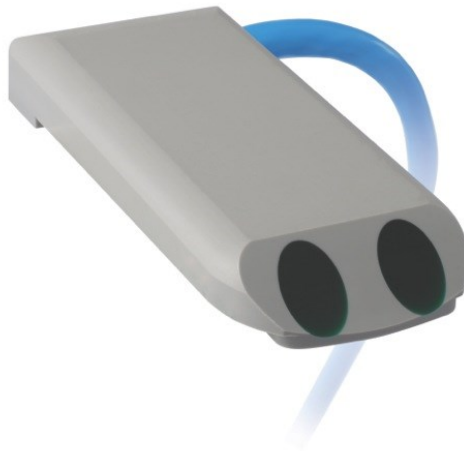

This type of configuration is used in full pipes when access to the pipe is available and the pipe can be emptied when installation or maintenance is required. Alternatively this sensor can be used in partially full pipes or open channels in conjunction with a MACE EchoFlo ultrasonic depth sensor.

ZX SnapStrap mounted Area/Velocity sensor

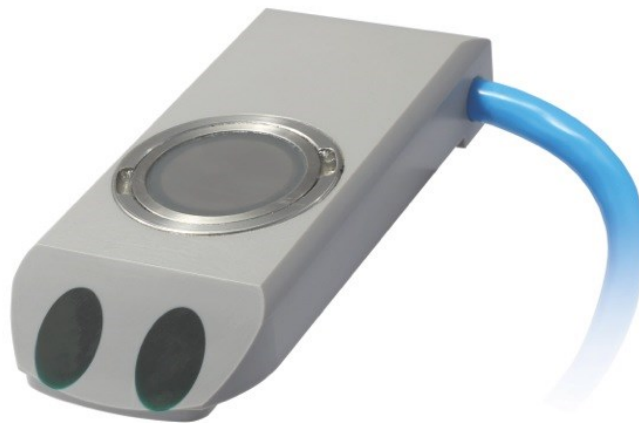

This combined velocity/depth sensor can be used in pipes that run partially full or in open channels.

The MACE Doppler ultrasonic ZX SnapStrap mounted velocity sensors are connected to a [FloSeries3 Doppler card](#).

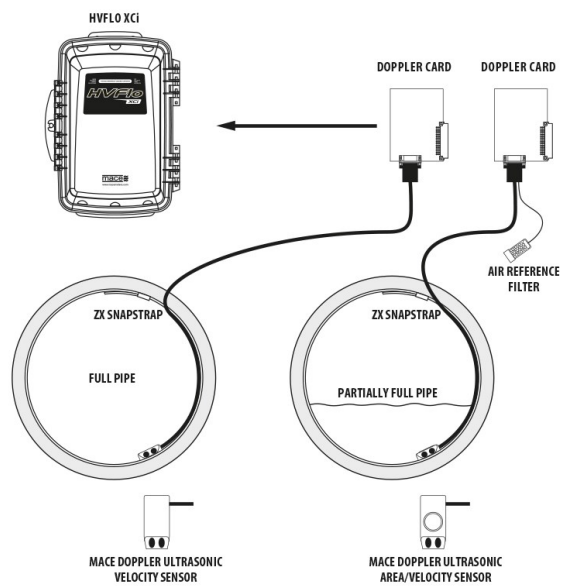

Selecting a suitable site for Doppler ultrasonic velocity measurement

When selecting a suitable site to measure flow you must consider the following:



NOTE: Doppler ultrasonic flow measurement is generally unsuitable for use in:

- Ground water measuring applications,
- High pressure centre-pivot or lateral-move irrigation equipment.

Does the stream flow that I wish to measure contain sufficient acoustically reflective particles such as sand, silt, dirt, leaves or air bubbles? (The stream that you wish to measure must contain at least 100 parts per million of acoustically reflective particles that are greater than 75 microns in size).

Yes – The stream flow is suitable for Doppler ultrasonic flow measurement.

No – The stream flow is unsuitable for Doppler ultrasonic flow measurement, use a MACE Electromagnetic insert flow sensor instead.



NOTE: If you are unsure of the amount/size of acoustic particles a general rule of thumb is that surface water flows should be flowing a minimum of 0.15 m/s (0.5 ft/s). Please do not hesitate to ask your local MACE representative.

If the pipe flows full, is the internal pressure of the pipe within the range 0 - 25 m (0 - 253kPa, 0 – 37 psi)?

Yes – The stream flow is suitable for Doppler ultrasonic flow measurement.

No – The stream flow is suitable for Doppler ultrasonic flow measurement only if it contains at least 100 parts per million of suspended solids that are greater than 75 microns in size.

Does the pipe in which I am measuring, run full or partially full?

Full – An insert velocity or velocity only sensor can be used.

Partial – A combined area/velocity sensor will be required.

What pipe diameter is suitable for MACE Doppler ultrasonics?

MACE recommends a maximum pipe diameter of 2.5m (100"). MACE Doppler ultrasonics WILL operate in larger pipes, but a reliable gauging MUST be performed for the most accurate readings.

Can I get access to the outside wall of the pipe for mounting the sensor?

Yes – Consider using an insert velocity sensor if the pipe runs full.

No – Must use a ZX SnapStrap mounted sensor internally.

Are there any other acoustic flow meters installed in the same pipe ?

Yes – Move the Doppler sensor installation point at least 25m away.

No – The stream flow is suitable for Doppler ultrasonic flow measurement.

Does the proposed site have obstructions in the pipe which might cause irregularities in the flow (eg. pumps, elbows, constrictions, valves, gates etc)?

Yes – You will need to install the sensor at a point where there is at least eight pipe diameters of straight pipe with no obstructions. MACE recommends that the sensor is mounted so that there is a distance of at least six pipe diameters of straight pipe in front of it and at least two pipe diameters of straight pipe behind it.

No – Even when there are no obvious obstructions, MACE recommends observing the instructions described above. In all cases, the sensor should be mounted so that it is as far away from any disturbance as practical.

MINIMUM STRAIGHT PIPE REQUIREMENTS

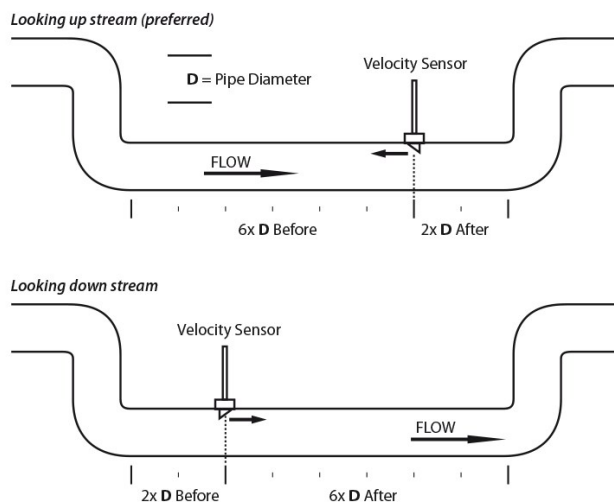

MINIMUM STRAIGHT PIPE REQUIREMENTS - BUTTERFLY VALVE

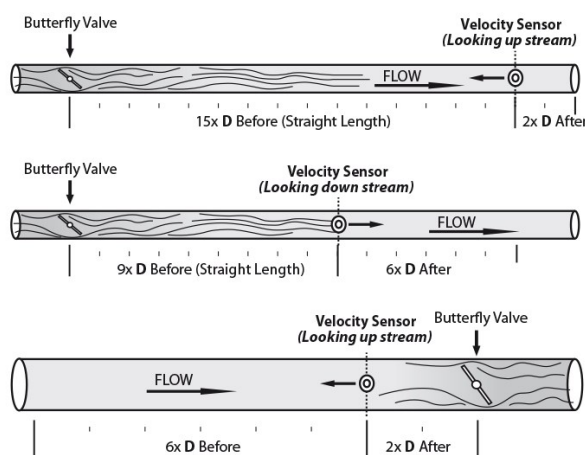

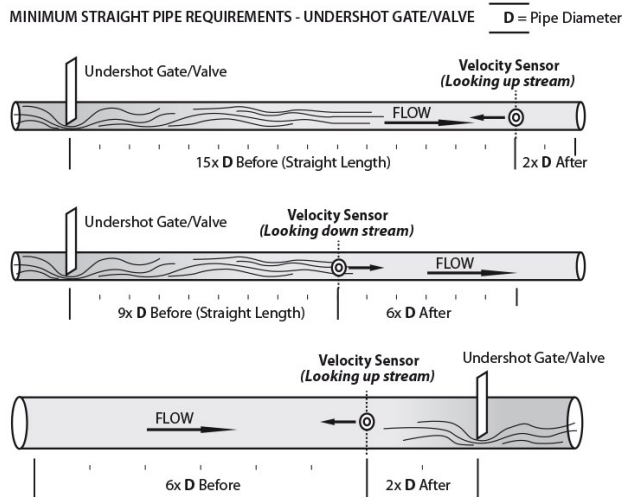

NOTE: Straight run requirements listed are "theoretical" minimums. In certain applications, more or less straight run may be applicable. If unsure about your specific site, please do not hesitate to consult your local MACE representative.

Where is the best place to mount the sensor in a Full pipe?

The sensor should be mounted on the side wall of the pipe, between the 2 and 5 o'clock positions. A ball valve should be used when mounting "Insert" type sensor to allow for easy maintenance.

SENSOR MOUNTING POSITION - FULL PIPE

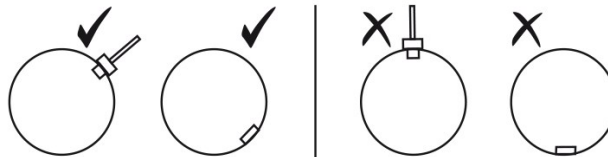

WARNING: Don't mount the sensor at the top of the pipe as air pockets could give unreliable readings. Don't mount the sensor at the bottom of the pipe as silt build-up can cover the sensor. Only mount the sensor between 2 and 5 o'clock as shown above.

Where is the best place to mount the sensor in a partially full pipe or channel?

The sensor must be mounted such that the depth sensor is always covered by water to a depth of at least 50mm (2 inches).

DEPTH SENSOR MOUNTING POSITION - PARTIALLY FULL PIPE



DEPTH SENSOR MOUNTING POSITION - OPEN CHANNEL



⚠ NOTE: Sensor should be mounted on the side of the channel when sediment or weed is present

⚠ NOTE: Straight run requirements for open channels are the same as for closed pipes. The "diameter" to use when calculating your straight run should be the maximum depth.

Where is the best place to mount the sensor in a corrugated pipe?

- **Insertion sensor:** this sensor type should always be mounted so that the leading edge of the sensor's angled face bisects the apex of a corrugated "ridge".

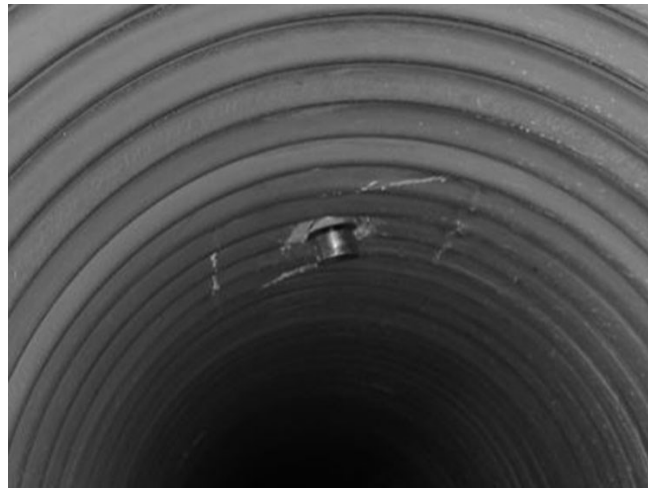

- **Strap mount sensor:** this sensor type should be mounted so that the corrugations are "filled in" to negate any debris attracting points around the sensor.

What size channel is suitable for MACE Doppler ultrasonics?

Mace recommends a maximum channel width of 20m (66ft). MACE recommends a reliable stream gauging be performed for best system accuracy.

Is there likely to be silt build-up over the sensor?

If this is the case, MACE recommends mounting the sensor on the side wall of the pipe instead of near the bottom of the pipe. See [diagram](#).

How far can the sensor be mounted from the XCi device?

A maximum of 50 metres (150ft) of cable is available on any MACE sensor.

How do I customise the XCi device for my application?

Use the application software, FloCom+to:

- Configure the unit for your site. For example, this includes setting the pipe diameter and logging interval.
- View the velocity profile measured by the sensors. This is useful if you think there may be irregularities in the flow at the site or you want to check the operation of the unit.
- Download data from the XCi device.

Installing a MACE Doppler ultrasonic insertion sensor



WARNING: DO NOT cut the sensor cable. Re-termination of the sensor is highly specialised and **MUST** be carried out at a MACE technical facility.



WARNING: Don't mount the sensor at the top of the pipe as air pockets could give unreliable readings. Don't mount the sensor at the bottom of the pipe as silt build-up can cover the sensor. Only mount the sensor between 2 and 5 o'clock as shown below. MACE recommends mounting the sensor facing upstream wherever possible.

1. Using a 2" coring bit (hole saw) appropriate for the pipe material (eg. in a concrete pipe MACE recommends the use of a diamond tipped bit), carefully core the pipe so that a clean cut is obtained.



NOTE: The hole should **ALWAYS** be only just bigger than the sensor head.

2. Measure and record the pipe wall thickness.
3. Attach a male 2" BSP or NPT nipple to the pipe **DIRECTLY CENTRED OVER THE HOLE** in a manner suitable for the pipe material. This fitting must:
 - Be at right angles to the flow
 - Provide for a clean join inside the pipe (no burring etc)
 - Be watertight



- Fit a full bore 2" gate or ball valve to the male nipple, using thread sealant to ensure that it makes a water tight seal.

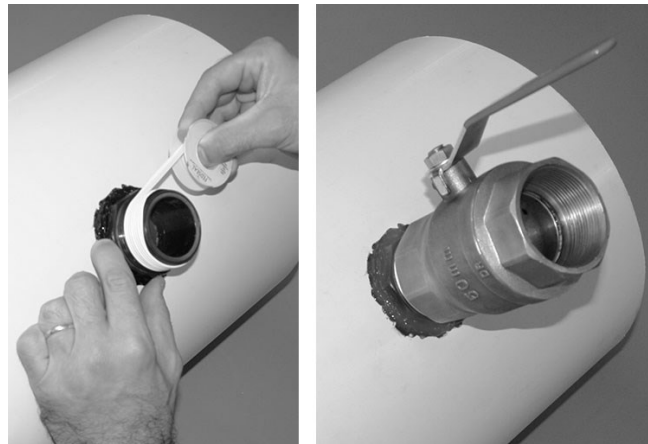

- You are now ready to insert the sensor but first you must determine how far into the pipe the sensor face needs to be inserted. The sensor face must be the only thing that protrudes into the flow as shown in the diagram.

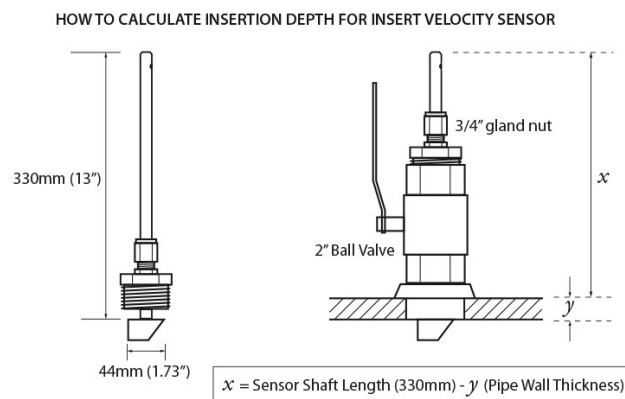

- Calculate *value x*.

$x = 330\text{mm} - y$

Value x is the difference between the shaft length (330mm / 13") and *value y* (the pipe wall thickness measured and recorded in step 2)

7. Apply thread sealant onto the thread of the sensor to ensure that it makes a water tight joint with the valve. Screw the sensor assembly into the valve.

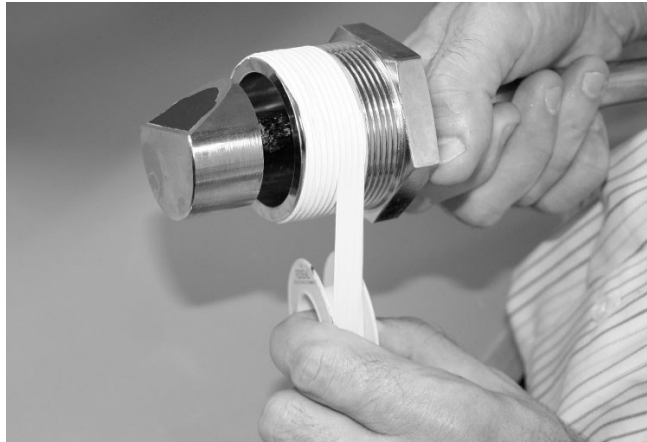

8. Make sure that the 3/4" gland nut is only finger tight. This will allow the sensor head to be moved freely while the head is aligned into the flow.

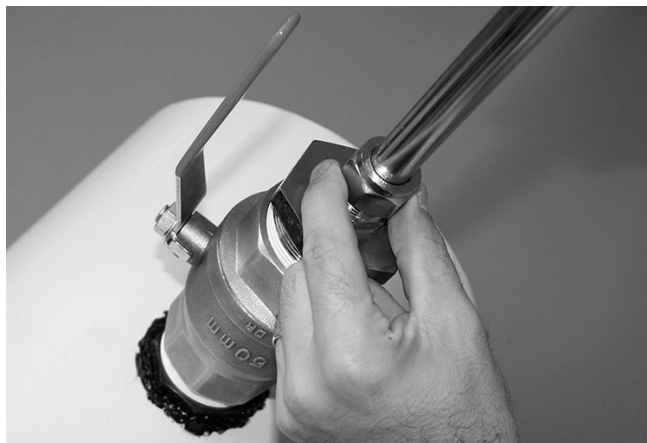

9. Open the valve fully and push the sensor head into the flow so it fully enters the stream without exposing any shaft. To get the sensor in exactly the right position you need to make the distance between the top of the sensor shaft to the top of the pipe wall the same as *value x*.

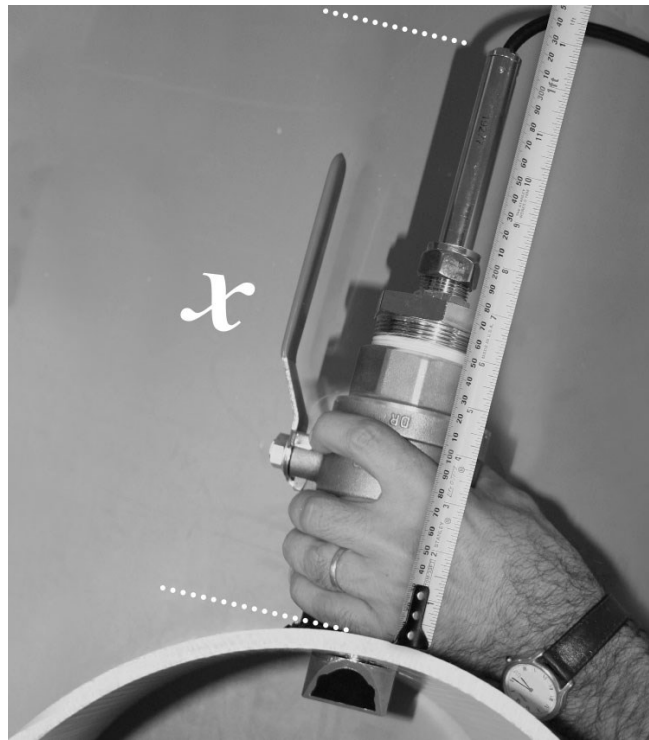

10. Now that the insertion depth is correct, rotate the sensor so that the grub screw at the top of the sensor shaft is roughly pointing in the direction of the longest straight section of pipe. Locate the plastic direction indicator tool that was supplied with the sensor. Clip the tool onto the stem of the insert sensor so that it is located in the two "blind holes" at the top of the stem with the grub screw facing the direction of the arrow.



NOTE: The grub screw indicates the velocity sensing face.

11. Sighting along the axis of the direction indicator tool, ensure that the sensor is **exactly parallel** with the axis of the pipe.



WARNING: Remember you *must* have a distance of at least six pipe diameters of straight pipe in front of the sensor and two pipe diameters of distance behind the sensor.



WARNING: According to AS4747 and NMI M10 Pattern Approval certification, the sensor *must* have a distance of at least 20 pipe diameters of straight pipe in front of the sensor and five pipe diameters of distance behind the sensor when positioned after a pump or two out-of-plane elbow fittings.

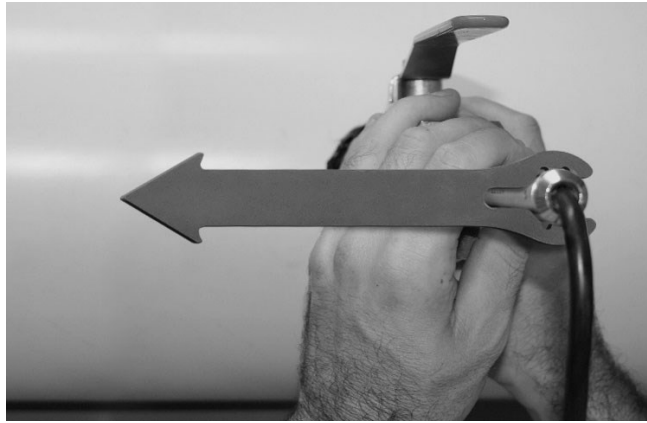

12. Tighten the 3/4" gland nut to lock the sensor in place. **Do not use thread sealant on the 3/4" gland nut.**



13. When the installation is complete, the sensor shaft should be pointing directly towards the centre of the pipe in all planes.

14. Carefully route the cable from the sensor back to where the XCi device enclosure will be mounted.



WARNING: Particular care should be taken when routing cables to ensure that moisture **CANNOT** enter the connector of the sensor cable as permanent damage may occur



NOTE: MACE recommends that all cables be appropriately routed through electrical conduit or other similar mechanism. MACE will not be liable for damage to cables, especially that caused by vehicles, digging implements, animals or debris in the pipe or channel.

Installing a MACE Doppler Area/Velocity sensor

There are two methods for mounting the MACE Doppler Area/Velocity sensor:

- Installation with a ZX SnapStrap - typically in pipes smaller than DN800 (32") and where sensors are mounted temporarily
- Installation with a mounting plate - typically in pipes larger than DN800 (32") and where sensors are mounted permanently

Installation with a ZX SnapStrap



WARNING: DO NOT cut the sensor cable. Re-termination of the sensor is highly specialised and MUST be carried out at a MACE technical facility.

The plastic (polypropylene) ZX SnapStraps are typically used to mount the sensor in locations where temporary monitoring will take place or when it is undesirable to drill in to the pipe wall. They allow for both very quick installation and removal of a strap mount sensor. The ZX SnapStrap comes in five lengths to suit different pipe diameters.

- 225-300mm (12" max)
- 300-450mm (18" max)
- 450-625mm (25" max)
- 600-725mm (29" max)
- 700-810mm (32" max)

Hold the sensor so that you can see the 'eyes' of the sensor in front of you, the sensor cable running to your left

1. Place the ZX SnapStrap on a flat surface so that you can see the chamfered edge of the strap in front of you. Place the 'toe' of the sensor into the front of the hole in the strap. Press the body of the sensor down onto the strap.

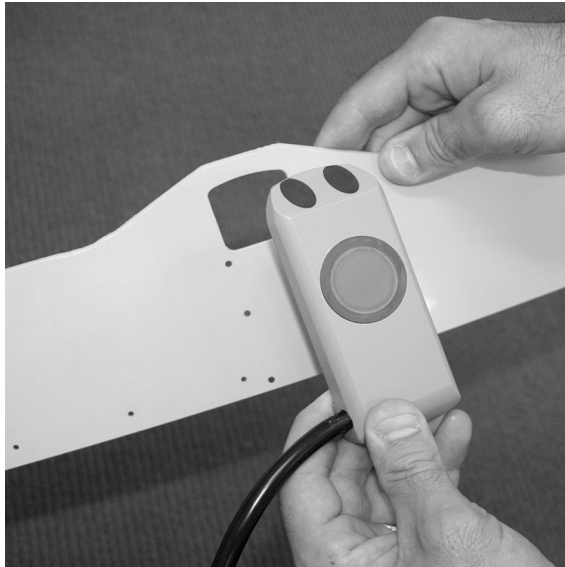

2. Turn the whole assembly over. Make sure the cut out in the strap sits down around the 'foot' on the sensor.

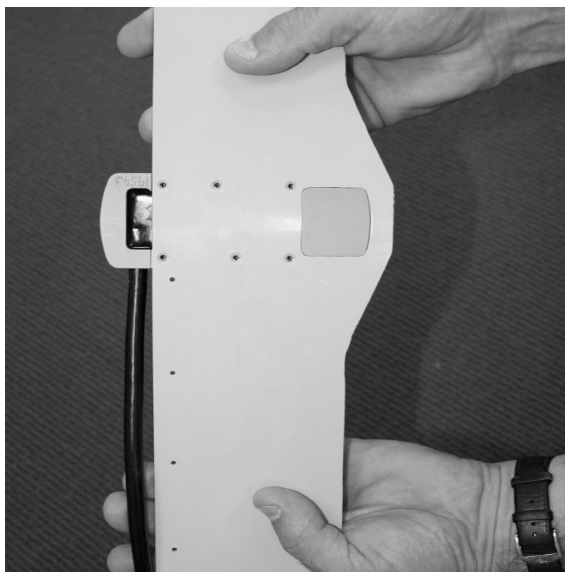

3. You should see six countersunk holes in the strap. Fit the six screws supplied (M3 x 8 mm Phillips head countersunk 304 s/s).

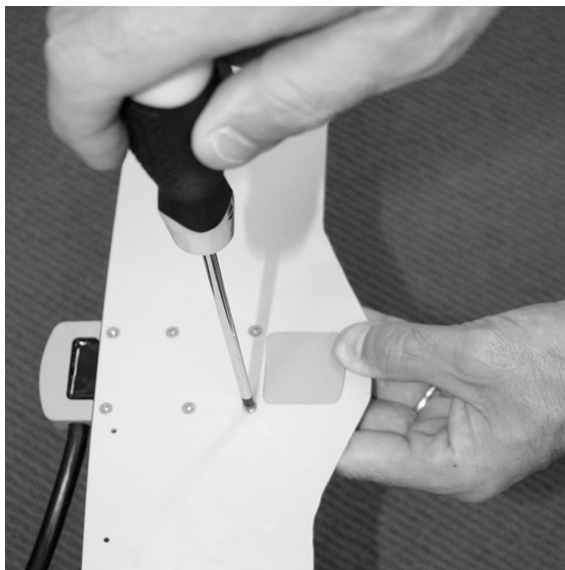

WARNING: Use only a hand screwdriver. Do not over tighten these screws as permanent damage to the thread may result

4. Tie the cable to the plastic strap using the holes and cable ties provided. Make sure that the knob of the cable tie sits to the back of the assembly, out of the flow. **DO NOT OVERTIGHTEN CABLE TIES.**



NOTE: The sensor is now ready to be installed in the pipe

5. Place the strap so you are behind the sensor looking upstream.



NOTE: Upstream is preferred (due to better debris shedding characteristics of the bevelled leading edge) but not critical as this can be reversed in FloCom+
Ensure that minimum straight pipe requirements are still met.

6. A stainless steel buckle is provided. Slide the buckle onto the ZX SnapStrap as shown.

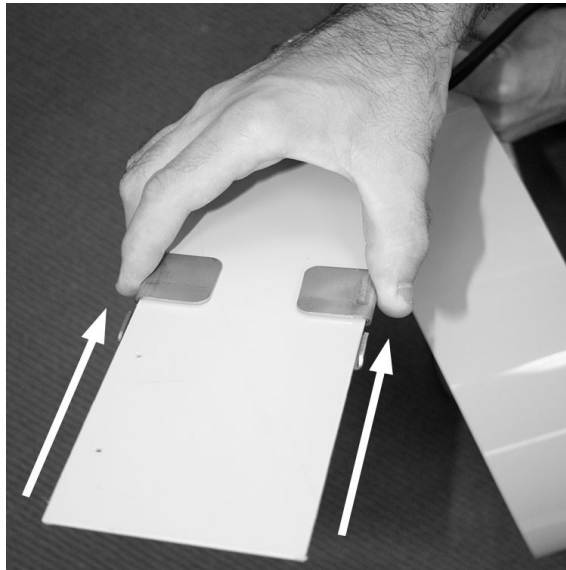

7. The left side of the strap will simply run through the buckle. The position of the buckle on the left side of the strap determines the diameter of the hoop. Therefore, the largest diameter occurs when you first place the buckle on the strap. The right side of the strap curves around inside the left and tucks into the buckle. Pick up the left side of the mounting strap and curve it over to form a semi circle.
8. Bring the right side of the strap up, inside the left and tuck into the ZX SnapStrap. The strap should now form a complete hoop.

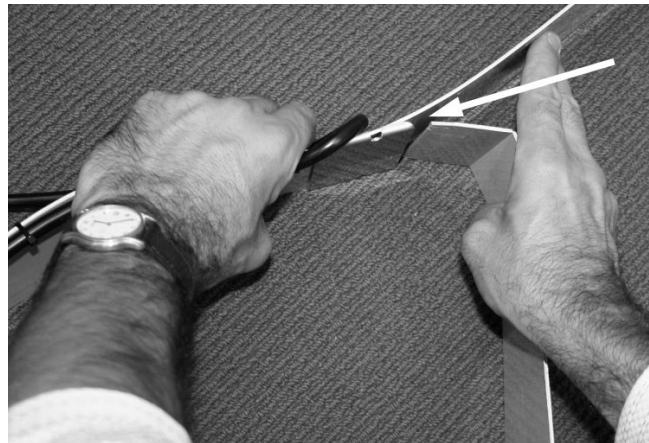

9. Position the buckle so that the whole assembly is slightly too large to comfortably fit in the pipe.

10. Now, form a 'Z' at the creases in the strap as shown below.

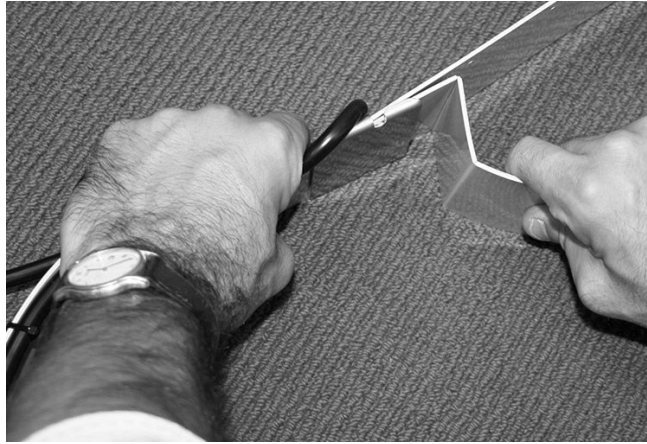

11. Hold the 'Z' with one hand, the sensor with the other and place the assembly into the pipe reaching as far as is comfortable. Ensure that the sensor is parallel to the flow and in the bottom part of the pipe, off set to either side (if there is a build up of debris the sensor will not get covered)

12. Press out the 'Z' in the hoop with the palm of your hand. The strap will 'snap' into place. You won't be able to move the ZX SnapStrap up or down the pipe by hand if done properly.

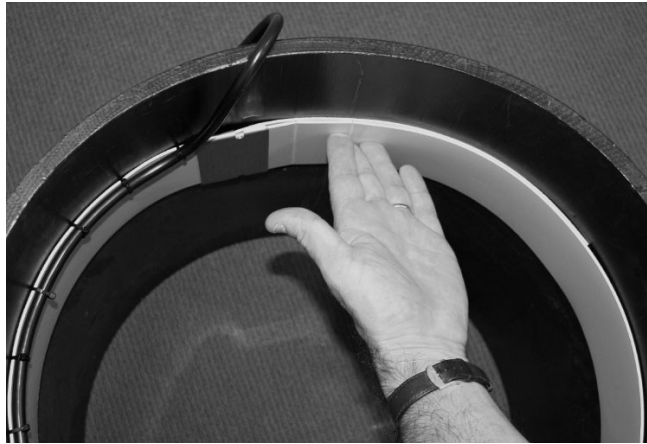
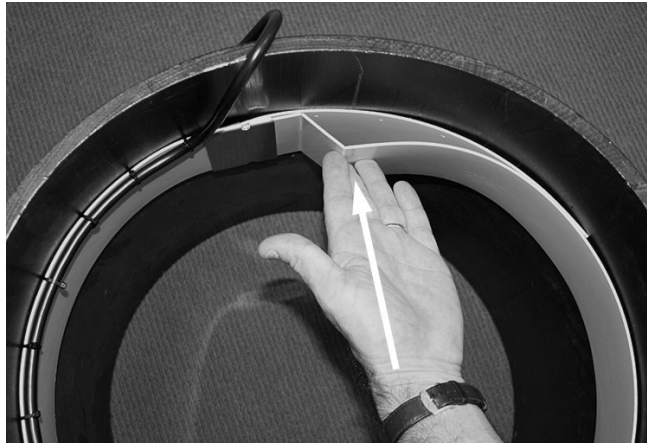

13. Carefully route the cable from the sensor back to where the XCi device enclosure will be mounted.



WARNING: Particular care should be taken when routing cables to ensure that moisture **CANNOT** enter the connector or the air reference line of the sensor cable as permanent damage may occur

14. To remove, open the strap by wedging a screwdriver into the flattened 'Z' and bearing down on the strap.



Installation with a mounting plate

DO NOT cut the sensor cable. Re-termination of the sensor is highly specialised and MUST be carried out at a MACE technical facility.

A mounting plate is normally used in large pipes where a cost-effective solution is required. The sensor is attached to the plate, which is then bolted to the inside surface of the pipe. This plate is supplied in polypropylene.

1. Attach the sensor head securely to the mounting plate by the six 3mm screws supplied (M3 x 8 mm Phillips head countersunk 304 s/s).

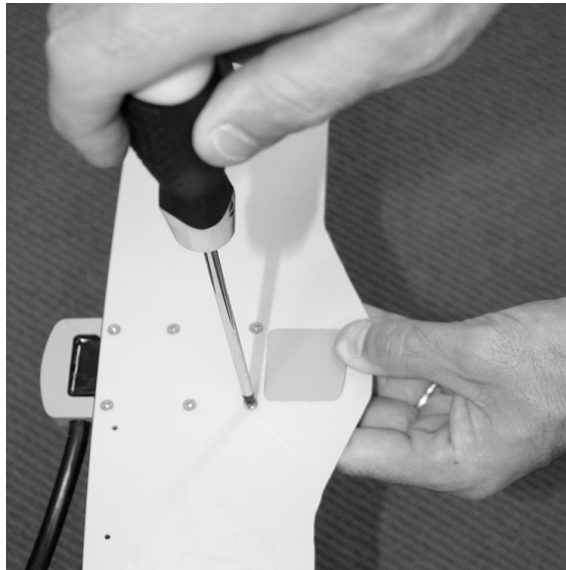

WARNING: Use only a hand screwdriver. Do not over tighten these screws as permanent damage to the thread may result

2. Tie the cable to the mounting plate using the holes and cable ties provided. Make sure that the knob of the cable tie sits to the back of the assembly, out of the flow. **DO NOT OVERTIGHTEN CABLE TIES.**
3. The cable from the sensor to the XCi device should then be run inside the pipe and secured to the pipe in such a manner as to prevent damage by debris in the pipe. The cable should be routed through electrical conduit.

- Using a fixing method that is suitable for the pipe material, the sensor plate should be attached to the pipe or channel in a position such that the sensor is always facing parallel with the pipe.

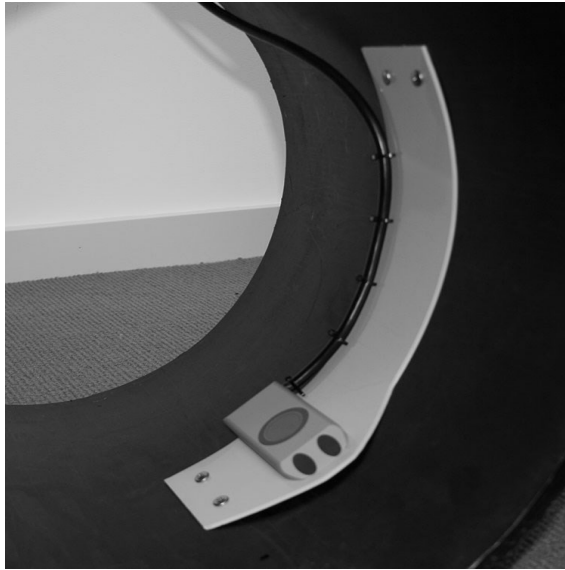

WARNING: Take care to ensure no gap exists between the plate and the pipe wall. This will stop the collection of debris.

- Carefully route the cable from the sensor back to where the electronics box will be mounted as described in installation of insertion sensors.



WARNING: Particular care should be taken when routing cables to ensure moisture **CANNOT** enter the connector or the air reference line of the sensor cable as permanent damage may occur.

See [Connecting a MACE Doppler ultrasonic sensor](#) for details on connecting the area/velocity sensor to the HVFlo XCi device

Installing a MACE Doppler velocity only sensor

There are two methods for mounting the MACE Doppler Area/Velocity sensor:

- Installation with a ZX SnapStrap - typically in pipes smaller than DN600 (24") and where sensors are mounted temporarily
- Installation with a mounting plate - typically in pipes larger than DN600 (24") and where sensors are mounted permanently

[Installation with a ZX SnapStrap](#)

[Installation with a mounting plate](#)

Introduction to FloSeries3 cards

Multiple cards for multiple sensor applications.

The HVFlo XCi system contains one "factory installed" FloSeries3 Doppler Card. A WebComm card may be factory installed upon request.



NOTE: Contact your local MACE representative should other card/s be required.

With a MACE WebComm card installed, your data can be accessed free, 24/7 from the MACE website via PC or smartphone.

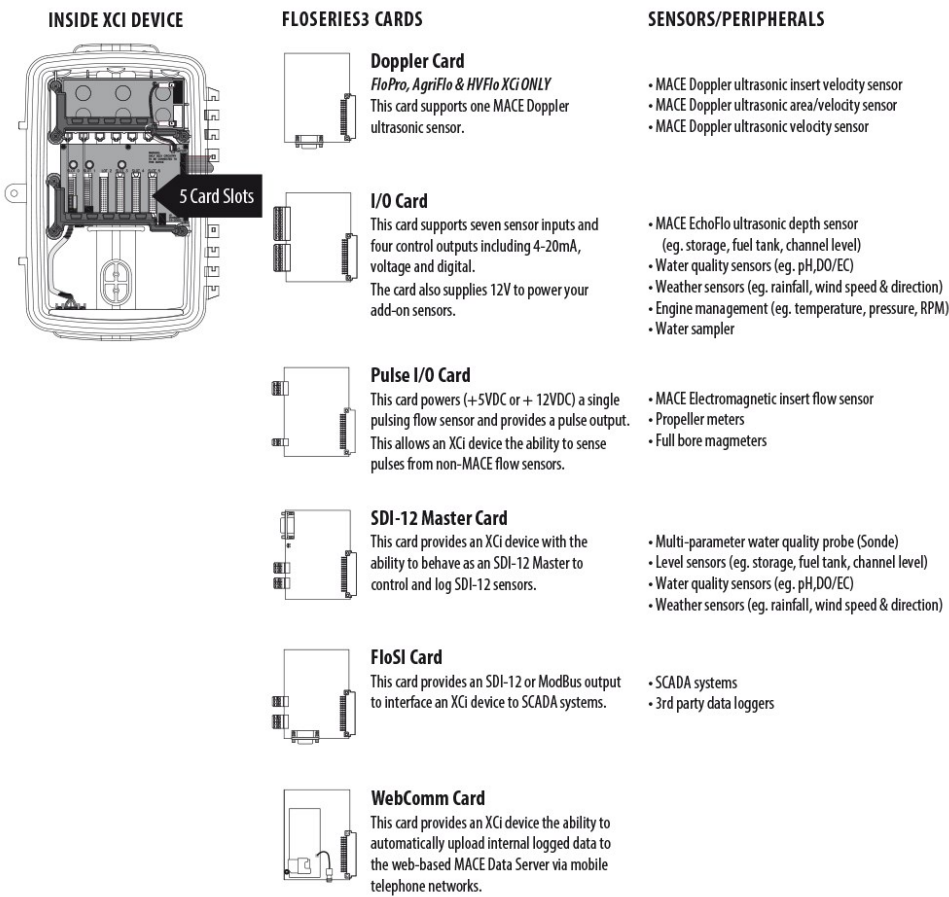

Installing FloSeries3 Cards



WARNING: Where this procedure is carried out on a system that has already been installed and a card/s is being replaced or added you **MUST**:

- [Connect](#) with FloCom+
- [Stop](#) the device
- [Save](#) the device settings
- [Download](#) the logged data
- [Disconnect](#) from the device

1. Open the HVFlo enclosure and ground yourself by touching the "spade" connector on the backplane board



2. Remove the three screws (using a #2 Phillips screwdriver) fastening the PCB clamping bracket.

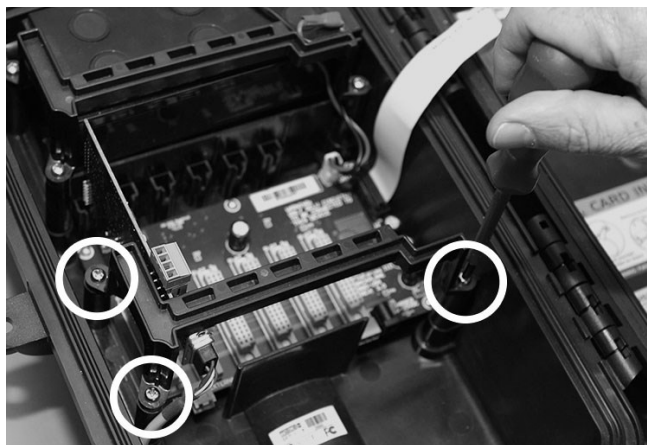



WARNING: Take care not to drop screws in the box as damage may occur to the circuitry

3. Ground yourself again as per instructions in Step 1.
4. Remove the FloSeries3 card from its packaging. Position the new card in your hand such that the large cream 48-pin connector is facing down and aligned with the mating connector on the backplane PCB.

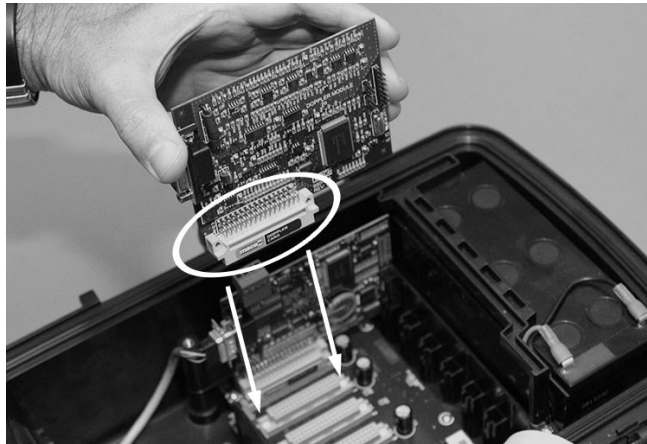

5. **Ground yourself again.** Your finger must remain grounded on the screw whilst carefully inserting the card into any spare slot. Take care to align the pins of the two connectors together. There is a slot at the top of the card area that helps the alignment process. Ensure that the card is contained within this slot and press down firmly to ensure that it is fully seated.



NOTE: If installing a WebComm card then you **MUST** use card slot 5.

6. Replace the PCB clamping bracket ensuring that the slots in the underside of the bracket are aligned with the tops of all the cards. Fix the bracket into place with the three screws.

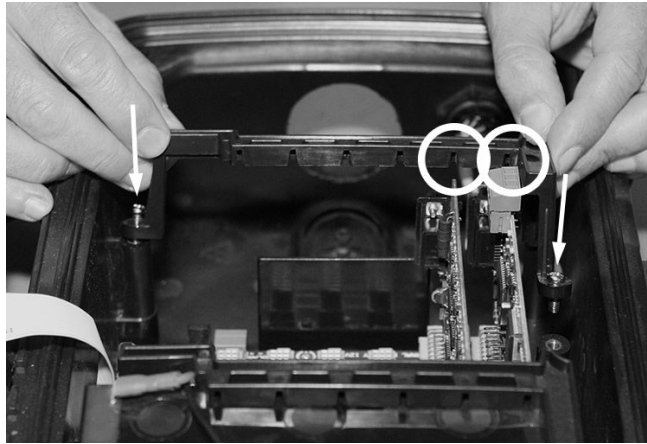

WARNING: DO NOT over tighten the screws as the bracket may be damaged or broken

7. “**Connect**” to the HVFlo XCi device with a PC using FloCom⁺ ([Connecting to an HVFlo XCi device](#))



- From the main menu of FloCom+ click "**System**" then "**Card check**" and ensure that your newly installed card/s are listed **and in the correct card slots**.

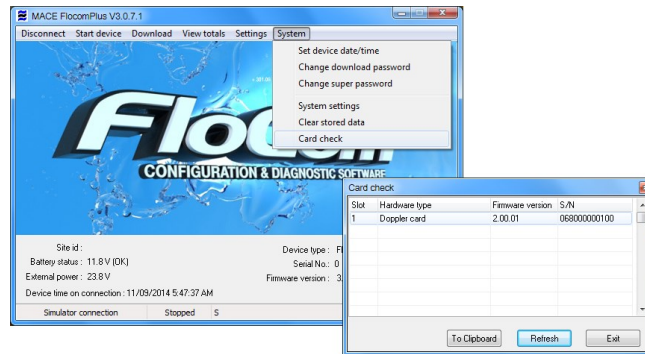

- If they are not listed and/or not in the correct slot, "**Disconnect**" from the device in FloCom+
- REMOVE** the offending card/s and **WAIT for at least one minute. This allows the microprocessor on the card to reset.** Follow steps 1-9 for re-installation.



WARNING: Before removing the card/s you MUST re-ground yourself by following the procedure outlined in step 1.

About the Doppler Card

Once installed (see [Installing FloSeries3 Cards](#)) the Doppler card provides the input for connecting MACE Doppler velocity sensors (A/V sensor, 2" Insert Sensor and Strap Mount Velocity Sensor) to an HVFlo XCi device. Each MACE Doppler sensor is terminated with a 9-pin IP68 "Buccaneer-style" connector that is plugged into the outside of the HVFlo XCi.

Once a sensor has been connected to the Doppler card it must be configured using FloCom+ software so that the HVFlo XCi device can control and record data from the sensor (see [Sensor Type:](#)).

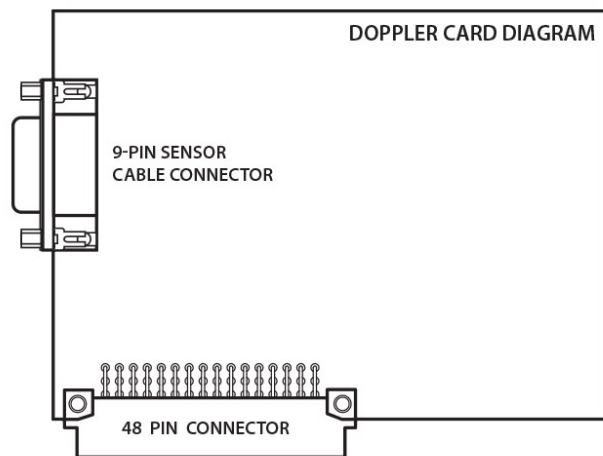

Recharging an HVFlo XCi

The HVFlo XCi can be charged from any DC source of 16-30 Volts (2 Amps).



NOTE: MACE recommends charging using the dedicated MACE Trickle Charger (850-323).

1. The charger available from MACE (Part No. 850-323) comes complete with a circular barrel connector that plugs directly into the XCi device.



NOTE: The barrel connector for the 16-30VDC charger input is centre positive

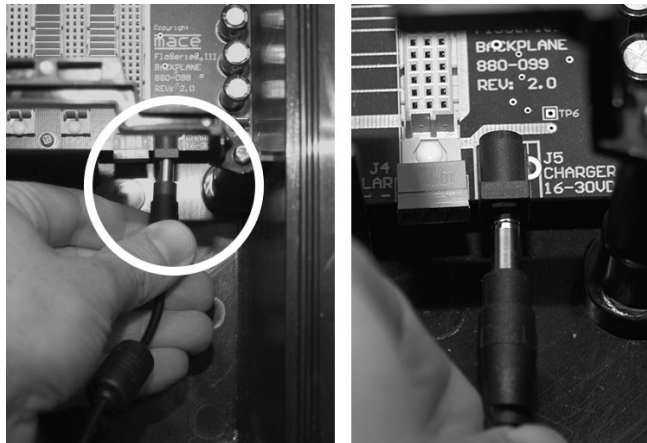

2. Alternatively, if a DC source other than a MACE charger is used, this is terminated using the three-pin connector adjacent to the barrel connector.



NOTE: MACE recommends the HVFi0 XCi is left on charge for at least 8 hours (overnight).

About the WebComm card

The MACE WebComm card provides all MACE XCi devices the ability to automatically upload internal logged data (via HTTP) to the web-based MACE Data Server via mobile telephone networks. The MACE Data Server is integrated with the www.macemeters.com and www.maceusa.com websites, and allows easy access for retrieval of field data. Unlike “conventional” data services, MACE provides this data server free of charge to its customers (subject to MACE SLA).

Alternatively, the WebComm card may be configured to upload via FTP directly to HydroVu Data Services or other FTP servers.



NOTE: Only a WebComm Gen2 card can perform FTP uploads.

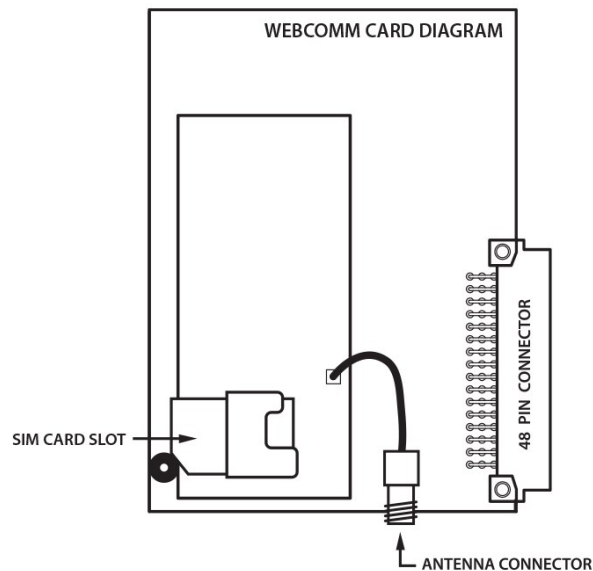

NOTE: Only one WebComm card per XCi device is supported. The WebComm card should be installed in card slot #5 of the XCi device



WARNING: The following "*Essential Steps*" are required to successfully setup a WebComm card and view data on the MACE data server.

Preparing and installing a Webcomm card



NOTE: Contact your cell provider for a SIM card/data plan.



NOTE: MACE recommends that all cables be appropriately routed through electrical conduit or other similar mechanism. MACE will not be liable for damage to cables, especially that caused by vehicles, digging implements, animals or debris in the pipe or channel.

1. Ensure the antenna cable is appropriately routed through conduit and entering the XCi enclosure.
2. Position the SIM card with the cutout notched corner on the right with the electronic chip facing down as shown.

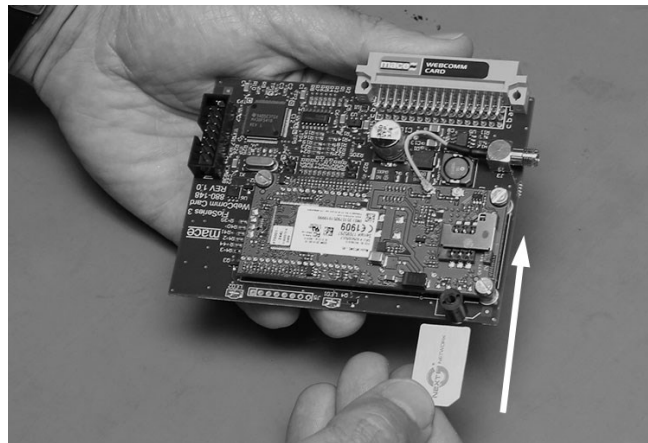

3. Slide the SIM card into the slot until it is fully seated and behind the small black "**holding pin**".

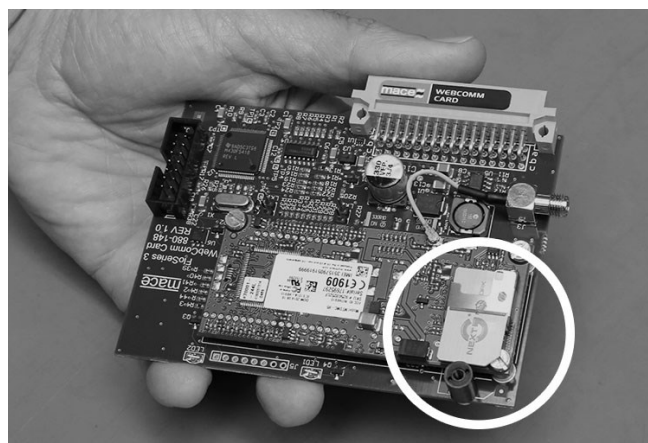

4. Screw the supplied antenna onto the SMA antenna connector.



WARNING: DO NOT USE tools to tighten antenna. Finger tighten only.

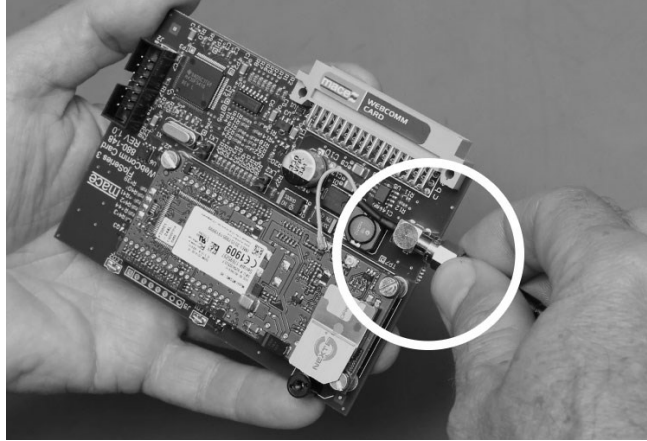

5. The WebComm card is now ready to be installed into the XCi device.
6. Follow [Installing FloSeries3 Cards](#) to install the WebComm card into the XCi device.

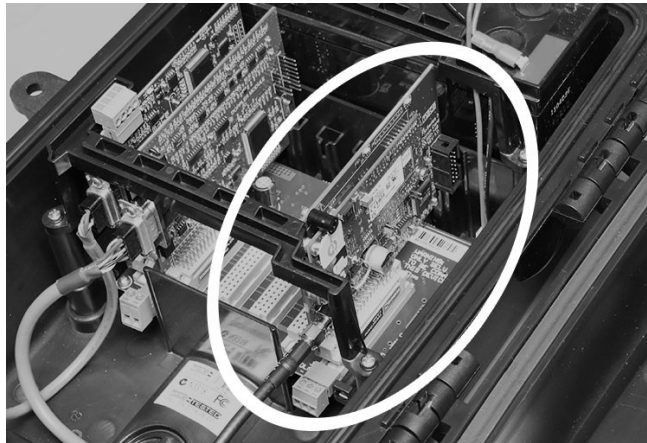

NOTE: The WebComm card should be installed in card slot #5 of the XCi device as shown

Add a WebComm site on the web



NOTE: If you haven't already done so, you need to register for a "**User Login**" on the www.macemeters.com website.

1. "**Login**" to www.macemeters.com with your "**User Login**" and "**Password**". Navigate to the "**WebComm**" page.
2. Click on the "**Add new site**" tab.

All times shown on this page are site local time.
Your current alarm credit is 0 alarms.

My sites | **Add new site** | **Purchase alarm credits**

Site ID: (maximum 8 characters) Fields marked with * are required.

Site Timezone:

Site Description:

Site Access:

- Allow MACE support staff to access this site
- Allow third-party applications to download site data directly from the MACE Data Server.

[Back to top](#)

3. Select a "**Site ID**". This should be the same "**Site ID**" that the XCi device in the field will have. Select the appropriate "**Site Timezone**" from the drop-down list and provide a "**Site Description**" if desired.



NOTE: The "Site ID" entered in this field will be overwritten by the "Site ID" of the XCi device in the field if it is different.



NOTE: MACE recommends that the user does not use daylight savings time. Users should set to standard time zone at all times.

4. Check the appropriate boxes for "**Site Access**"
 - Allow MACE support staff to access this site to enable quick and easy help and problem diagnostics
 - Allowing third-party applications to download site data directly, enables other manufacturers software to directly interrogate the MACE Data Server which alleviates the need for access through the MACE website.
5. Click "**Save site details**" and the "**My sites**" tab-sheet will appear.

All times shown on this page are site local time.
Your current alarm credit is 0 alarms.

Site ID	Site Description	Latest Record
WCTest	WebComm Test Site for XCI Manual	

[Back to top](#)

- Click on the "**Site ID**" hyperlink of the site you've just added, and you will be directed to the "**Site Information**" page.

Site information

[Site details](#) [Site data](#) [My sites](#)

All times shown on this page are site local time.

Site data

[Download site data](#) [Show latest record](#) [Delete site data](#)

Site ID: **WCTest**
Site description: **WebComm Test Site for XCI Manual**
Last record downloaded: **You have not downloaded any of the data available.**
Suppress status messages:
Enter start date: Enter end date:
YYYY-MM-DD or YYYY-MM-DD HH:MM:SS
Leave blank for all data
[View site data](#) [Download site data](#)

[Back to top](#)

Site details

[Site details](#) [Site keys](#) [Site alarms](#) [Site users](#) [Remove site](#) [Alarm history](#)

Last update: 2014-11-05 12:32:24 [Edit site details](#)

Site ID: **WCTest**
Site Timezone: **(UTC+10:00) Australia Eastern Time**
Site Description: **WebComm Test Site for XCI Manual**
Site Access: **MACCE support staff have access to this site.**
Data from this site can be downloaded directly from the MACCE data server.
Oldest data record: **There is no data stored for this site.**
Last record uploaded: **There is no data stored for this site.**
Server storage used: **There is no data stored for this site.**
Device type:
Serial number:
Firmware:
Signal strength: **0**

[Back to top](#)

- From within the "**Site details**" area of the page, click on "**Site keys**" tab.

Site details

[Site details](#) [Site keys](#) [Site alarms](#) [Site users](#) [Remove site](#) [Alarm history](#)

Device upload configuration

These parameters must be entered into the device configuration before data can be uploaded.

Username: [Edit username in your profile](#)
Site upload key: **BLUW-UFPY-E4MC** [Change upload key](#)
[Save upload details to a text file](#)

Device download configuration

These parameters must be used when downloading site data directly from the MACCE data server.
You do not need to use these parameters if you are downloading your data via this website.

Username: [Edit username in your profile](#)
Site download key: **There is no download key set for this site** [Set download key](#)

[Back to top](#)

- If this is the first time you have added a WebComm site you must create a new "**Username**". Click on the "**profile**" hyperlink and you will be re-directed to the "**WebComm settings**" tab sheet of the "**My Details**" page of the website.

- Click on "**Change**" and a field will appear where you may create a "**Username**". Click "**Save username**" and navigate back to the WebComm "**Site information**" page, and then the "**Site keys**" tab sheet.

The screenshot shows the 'Webcomm settings' page with the 'Change password' tab selected. Below the settings table, there is a 'Create username' dialog box. The dialog has a red error message: 'A username is required before you can add a new site.' It contains a text input field with 'UserName' entered, a 'Required: Your username must be at least 4 characters long.' message, and 'Save username' and 'Cancel' buttons.

Below the dialog is the 'Site details' page with the 'Site keys' tab selected. It shows the 'Device upload configuration' section with the following details:

Device upload configuration	
These parameters must be entered into the device configuration before data can be uploaded.	
Username: UserName	Edit username in your profile
Site upload key: BLUW-UPFY-E4MC	Change upload key
	Save upload details to a text file



NOTE: This Username must be at least 4 characters long and only contain letters and numbers.

- The details that you will require to configure your MACE WebComm card in the field are located in the "**Device upload configuration**" field. Click on the "**Save upload details to a text file**" hyperlink and the details will be saved to a text file called "**Site upload configuration (Site ID).txt**". This text file will be needed when you are configuring the WebComm card in the field.



NOTE: The WebComm card is now ready to be configured using FloCom+ software. See [Configure a WebComm card using FloCom+](#)

Configure a WebComm card using FloCom+

This procedure should be undertaken after the WebComm and SIM has been installed *per* [Preparing and installing a Webcomm card](#)



NOTE: You will need the "**Bearer information**" supplied by your cell provider for the SIM card/data plan.

1. From the "**Device settings**" dialogue box, click "**WebComm**" and the "**WebComm card configuration**" will appear.

Webcomm card configuration

Upload interval: disabled Show passwords

Bearer APN:

Bearer user name:

Bearer password:

SIM card PIN:

MACE Server

URL: http:// data.macemeters.com

User name:

Upload key: Enable Remote Connection

HTTP upload

Enabled Use MACE server

URL: http://

User name:

Password: Correct clock using host time

FTP upload

Enabled Use Hydrovu Server

URL: ftp://

Directory:

User name:

Password:

Apply Exit

2. Enter the appropriate "**Bearer information**" as supplied by your cell network provider
 - "**Bearer APN**" - Bearer Access Point Name
 - "**Bearer user name**" - if required
 - "**Bearer password**" - if required



NOTE: SIM cards provided by MACE and In-Situ both require the APN to be set to - EM



NOTE: "SIM card PIN" - MACE recommends disabling any PIN

3. Enable either "**HTTP Upload**" or "**FTP Upload**" by checking the appropriate box.



NOTE: The MACE WebComm card can perform both an HTTP and FTP upload simultaneously. This means for example, that data can be sent to the In-Situ HydroVu FTP server or a water authority FTP server as well as the MACE HTTP Data Server.

HTTP Upload



NOTE: Unless using a different data server, leave the HTTP Upload "Enabled" and "Use MACE Server" check boxes ticked.

1. The "**Server URL**" should remain as "**data.macemeters.com**" unless you are uploading to a different HTTP server.
2. From the information contained in the file called "**Site upload configuration (Site ID).txt**" that was saved during the procedure outlined in [Add a WebComm site on the web](#), copy/paste the relevant "**Server user name**" and "**Upload key**".

```
File Edit Format View Help

Webcomm card site upload configuration

SiteID:           WCTest
Site description: WebComm Test Site for XCi Manual

Username:         UserName
Site upload key:  BLUW-UFPY-E4MC
```



NOTE: Check on "**Show passwords**" to enable easy viewing of the "**Upload key**"

3. Leaving the "Enable Remote Connection" check box ticked will allow for [Remote communications with an XCi device](#)
4. Checking the "**Correct clock using host time**" check box, will ensure that your XCi device time will always be correct. The WebComm card will "talk" to the MACE data server and correct the device time as necessary. This ensures you always have the correct time in your dataset.

Webcomm card configuration

Upload interval: 1 hour Show passwords

Bearer APN: Cell Provider APN

Bearer user name:

Bearer password:

SIM card PIN:

MACE Server

URL: http:// data.macemeters.com

User name: UserName

Upload key: BLUW-JFPY-E4MC Enable Remote Connection

HTTP upload

Enabled Use MACE server

URL: http://

User name:

Password: Correct clock using host time

FTP upload

Enabled Use Hydrovu Server

URL: ftp://

Directory:

User name:

Password:

Apply Exit

FTP Upload to In-Situ HydroVu Data Server



NOTE: If you are using the HydroVu Data Server, contact your local MACE or In-Situ representative for the authentication details required.

1. Leave the "**Use HydroVu Server**" box checked.
2. Enter the authentication details as supplied by MACE or In-Situ.

Webcomm card configuration

Upload interval: 1 hour Show passwords

Bearer APN: Cell Provider APN

Bearer user name:

Bearer password:

SIM card PIN:

MACE Server

URL: http:// data.macemeters.com

User name: UserName

Upload key: BLUW-UFPY-E4MC Enable Remote Connection

HTTP upload

Enabled Use MACE server

URL: http://

User name:

Password: Correct clock using host time

FTP upload

Enabled Use Hydrovu Server

URL: ftp:// ftp.hydrovu.com:2121

Directory: ./

User name: UserName

Password: 12345678

Apply Exit

3. The "**HydroVu headers**" must now be [Edit HydroVu Headers](#)

FTP Upload



NOTE: If you are using FTP uploads to an FTP data server, contact your Network Administrator for the server details required.

1. Enter the "**Server URL**"
2. Enter the file "**Directory**"
3. Enter the authentication details as required.

Webcomm card configuration

Upload interval: 1 hour Show passwords

Bearer APN: Cell Provider APN

Bearer user name:

Bearer password:

SIM card PIN:

MACE Server

URL: http://data.macemeters.com

User name: UserName

Upload key: BLUW-JFPY-E4MC Enable Remote Connection

HTTP upload

Enabled Use MACE server

URL: http://

User name:

Password: Correct clock using host time

FTP upload

Enabled Use Hydrovu Server

URL: ftp://ftpserver.test.com

Directory: /uploads

User name: UserName

Password: 12345678

Apply Exit

3. Select the appropriate "**Upload interval**" for your application from the drop-down list.
4. Click "**Apply**", then "**Exit**" to return to the "**Device settings**" dialogue box.
5. You should now run [The "WebComm Utility"](#)

Edit HydroVu Headers

Get real-time, decision-quality data on your remote monitoring sites anywhere, anytime, with In-Situ HydroVu Data Services. HydroVu gives you up-to-date access to your data while simplifying the task of filtering the data for important results.



NOTE: Visit [HydroVu Data Services](#) for further details.

After enabling [FTP Upload to In-Situ HydroVu Data Server](#), the following procedure must be carried out to ensure that data is visible on the HydroVu platform:

1. The "**HydroVu headers**" dialogue box will now be enabled on the "**Device settings dialog**"

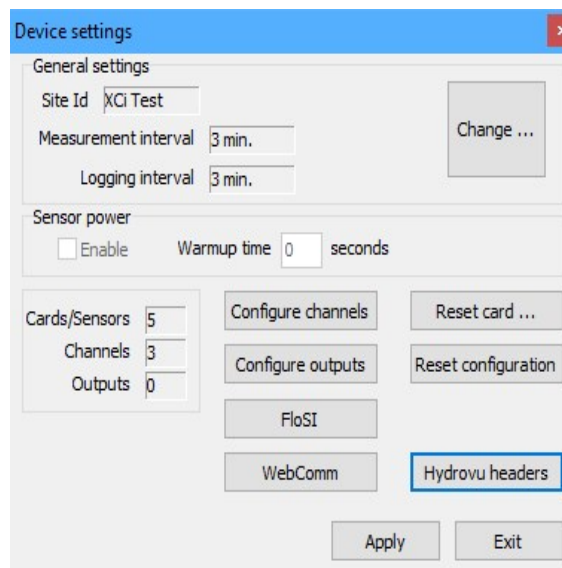

2. Click on "**HydroVu headers**" menu item and the "**HydroVu header information**" box will appear.

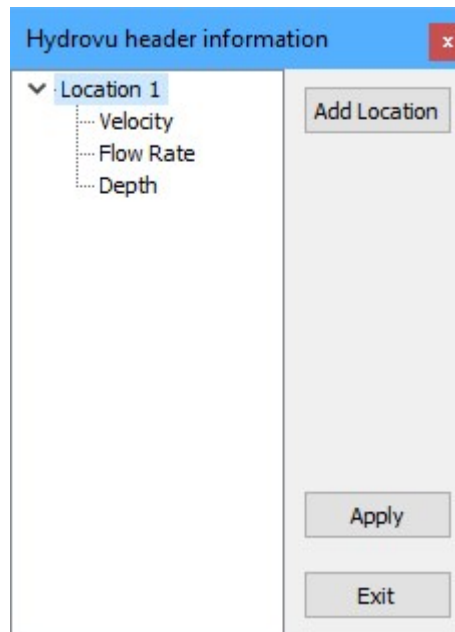

The following "**XCi Channel types**" are supported implicitly within HydroVu. That is, the full range of data viewing and analysis features are available. For "**Channel types**" not supported, HydroVu provides only viewing functionality.

Supported Channel types	Supported units
Velocity	m/s, ft/s
Depth	m, ft
Flow rate	L/s, L/h, kL/day, ML/day, m3/s, m3/h, gal/s, gal/min, gal/h, Mgal/day
Flow Total Net, permanent	L, kL, m3, ML, gal, Mgal, acre-in, acre-ft
Flow Total Net, resettable	L, kL, m3, ML, gal, Mgal, acre-in, acre-ft
Flow Total Positive only, permanent	L, kL, m3, ML, gal, Mgal, acre-in, acre-ft
Flow Total Positive only, resettable	L, kL, m3, ML, gal, Mgal, acre-in, acre-ft
Flow Total Negative only, permanent	L, kL, m3, ML, gal, Mgal, acre-in, acre-ft
Flow Total Negative only, resettable	L, kL, m3, ML, gal, Mgal, acre-in, acre-ft
Battery Voltage	V

Supported Channel types	Supported units
External Voltage	V
Stream index	none

3. Within the HydroVu platform, data is stored in an array consisting of the XCi [Site ID](#) and its related user-defined HydroVu location set in the "**HydroVu header information**" box. The "**Location**" can be re-named by left-clicking on the current location name and entering a new name. The "**Location**" should be something "meaningful" to the user. In the example below, "**Location 1**" has been re-named "**Pump XYZ**".

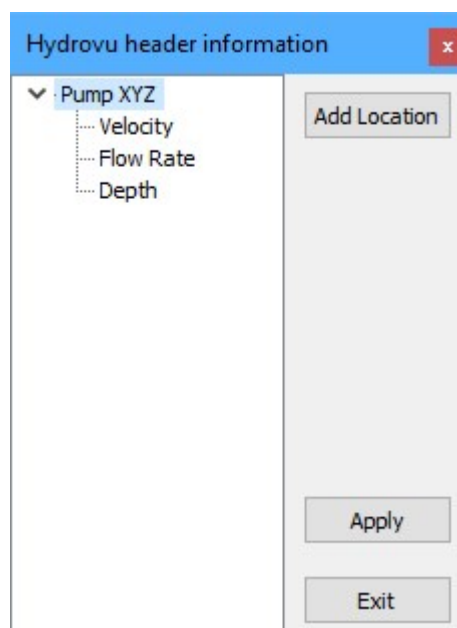

4. Further locations can be added by clicking on the "**Add location**" menu item.
5. "**Channels**" can be moved to a different "**Location**" by dragging and dropping onto a "**Location name**".

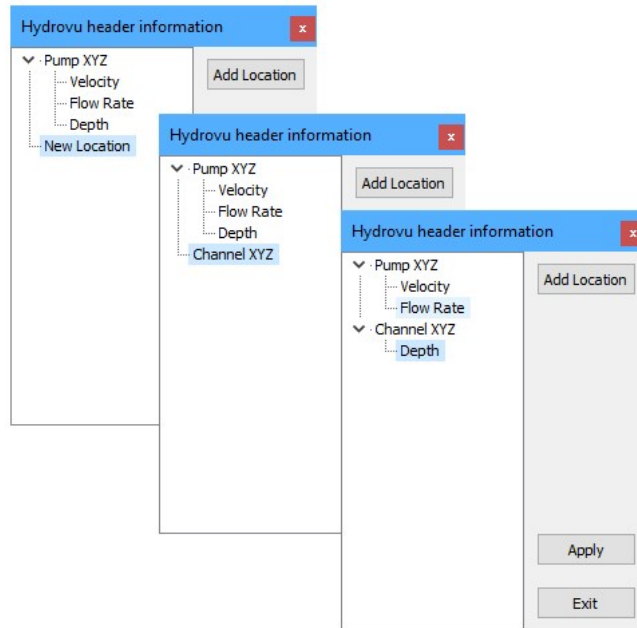

NOTE: A "Location" may only have a single instance of a particular "Channel type".

6. Click "**Apply**" and then "**Exit**" to return to the "**Device settings dialog**".



NOTE: Empty "Locations" will be removed from the "Header information" upon "Applying".

The "WebComm Utility"

This utility provides the user with a simple diagnostic interface to communicate with the WebComm card in order to test the settings and initiate a data upload on the MACE data server. The utility also has an handy feature that enables direct AT command communication with the modem.

From the "**Device settings**" dialogue box click "**WebComm utility**" and the "**WebComm utility**" dialogue box will appear.

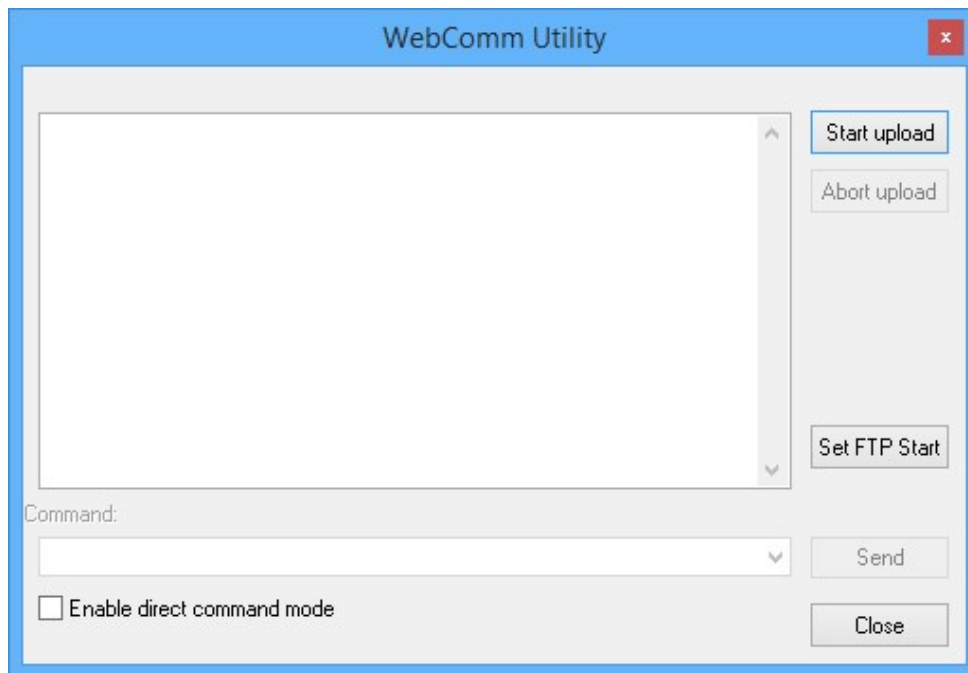

NOTE: The "*Set FTP Start*" will only appear if FTP uploads have been enabled.

Test an *HTTP Upload*



NOTE: If this is your first "*Upload*", you may need to run the "[*Initial upload routine*](#)" described below

1. Click "**Start upload**" and the utility will "force" the WebComm card to talk to the data server and upload any data stored in the log. A successful upload will be completed if all the "**Settings**" in the WebComm card have been entered correctly and there is a cell network in range with sufficient signal strength.



NOTE: The “*Signal strength*” is a measure between 0 and 30. For reliable uploads a “*Signal strength*” of at least 10 should be attained. If a “*Signal strength*” of 10 is not attained, then a higher gain antenna should be used.

2. If “**Upload completed successfully**” then click “**Close**” to exit from the WebComm utility. “**Start**” the device as described in [Start/Stop HVFlo XCi device](#) after the device has been fully configured. Your data will now be uploaded regularly to the data server for storage and available for retrieval at www.macemeters.com

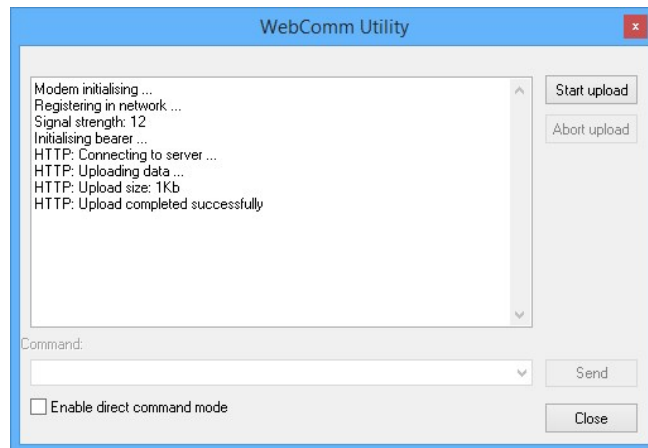

3. If the upload was not successful refer to the “[Error messages table](#)” to troubleshoot the WebComm card.

Test an *FTP Upload*



NOTE: If this is your first “*Upload*”, you may need to run the “[Initial upload routine](#)” described below

1. Click “**Set FTP Start**” and enter the start time from which the WebComm card will upload data stored in the log.

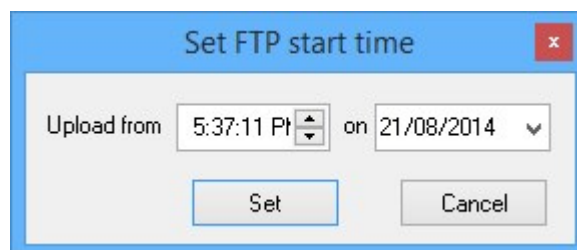

2. Click **“Start upload”** and the utility will “force” the WebComm card to talk to the FTPserver and upload any data stored in the log. A successful upload will be completed if all the **“Settings”** in the WebComm card have been entered correctly and there is a cell network in range with sufficient signal strength.



3. If **“Upload completed successfully”** then click **“Close”** to exit from the WebComm utility. **“Start”** the device as described in [Start/Stop HVFlo XCi device](#) after the device has been fully configured. Your data will now be uploaded regularly to the FTPserver for storage.
4. If the upload was not successful refer to the [“Error messages table”](#) to troubleshoot the WebComm card.

Error messages table:

Error message	Possible cause	Remedy
Didn't register in network	No cell network available	Check with cell provider that you are in a coverage zone
	Wrong cell network	Check with cell provider that you are in a coverage zone
	Low cell signal strength	Check the antenna connection. Run signal strength command in WebComm utility (AT+CSQ). A high gain antenna may need to be installed in low signal strength areas
	Antenna not connected	Ensure antenna connected properly

Error message	Possible cause	Remedy
	Incorrect modem band	Run band check command in WebComm utility (AT+WMBS?). Ensure the correct band for your location is set. WebComm Gen1 <u>only</u>
Bearer error	Network busy	Wait, try again
	Low cell signal strength	Check the antenna connection. Run signal strength command in WebComm utility (AT+CSQ). A high gain antenna may need to be installed in low signal strength areas.
	Incorrect settings in the WebComm card	Check bearer settings with cell provider
HTTP authentication error	Incorrect username or upload key	Check username and upload key and correct if necessary
CMEE error	Probable modem not initialised error	Wait, try again
Data limit reached	WebComm will only upload ~100Kb at a single upload	" Force " another upload, or " Start " the device (Start/Stop HVFlo XCi device) and the WebComm will "catch-up" over subsequent upload periods
Error connecting to server	Incorrect setting in WebComm card	Check the server URL (Configure a WebComm card using FloCom+)
No SIM	No SIM installed	Install SIM card (Preparing and installing a Webcomm card)
Socket timeout	Timeout during socket transaction	Wait, try again
Network timeout	Network busy	Wait, try again
HTTP XXX	Error communicating with server	Try again. If error persists con-

Error message	Possible cause	Remedy
		sult MACE vendor for assistance (see also List of HTTP status codes)
Modem error 0	Modem didn't activate	Wait, try again
Modem error 1	Modem didn't respond to a command	Wait, try again

Using "AT+ commands" to troubleshoot a WebComm card

This WebComm utility has a "**Command**" field where AT+Commands can be input to troubleshoot various parameters of the WebComm card. These AT+Commands are accessed via the drop down menu of the "**Command**" field or by direct input.



NOTE: Check "*Enable direct command mode*". This enables the modem for direct communication via AT+Commands

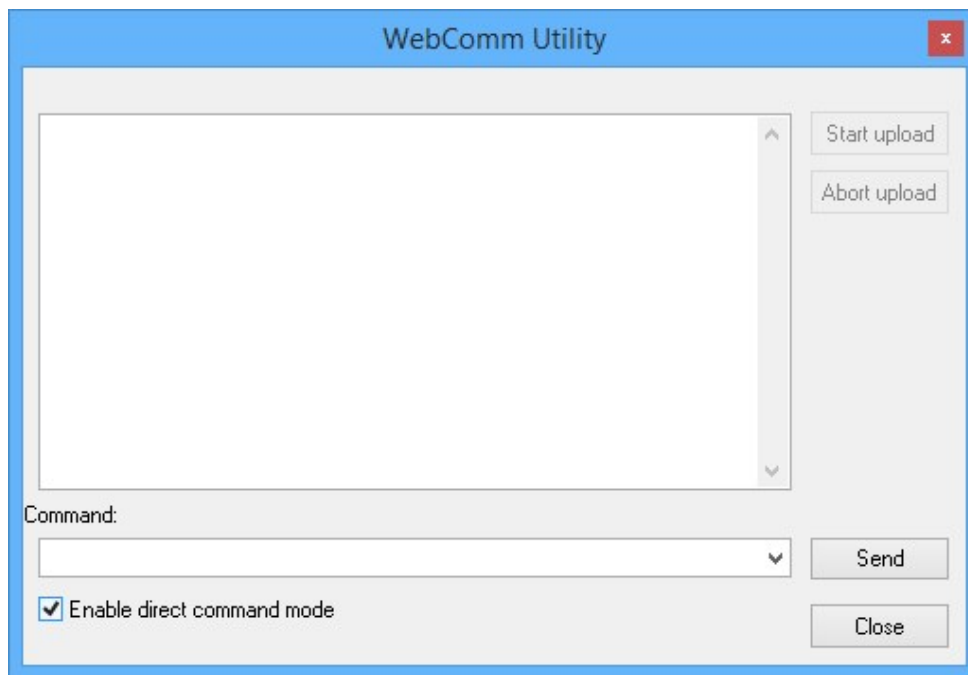

Initial upload routine:

1. After checking the "**Enable direct command mode**" box, wait until you see:
+CREG: 1
+CGREG:1
#QSS:3

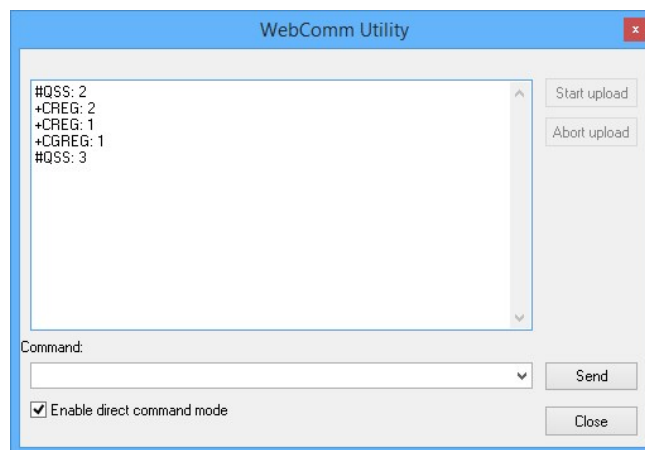

NOTE: The modem may take up to 2 minutes to register in a network for the first time. This is initialising the SIM card and is normal. Future registration attempts will be quicker.



NOTE: You may see +CREG:5 instead of +CREG:1 if you have a cell provider that "roams" on another network.

2. Type "**AT+COPS?**" into the command field and click "**Send**". The modem will respond with the current network identifier.

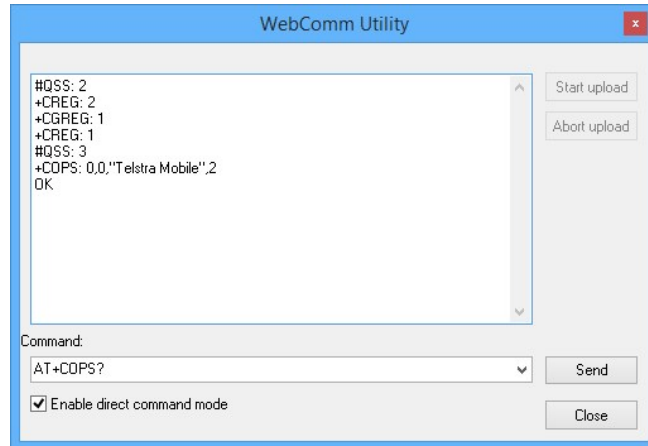

In the example above, the modem is connected on the "Telstra Mobile" network in Australia. In the USA, a network may identify with "T-Mobile" or "AT&T"

3. The SIM has been initialised and a normal "**Upload**" should be carried out as shown above.

Common AT+ commands

AT+ Command	Description
ATI9	WebComm Gen1 ONLY. MACE internal diagnostic use
AT+CSQ	Used to verify the Received Signal Strength

AT+ Command	Description																																			
	<p>Enter the AT+command " AT+CSQ " and click " Send "</p> <p>The response returned has the following format:</p> <p>+CSQ: <rss>,<ber> with:</p> <ul style="list-style-type: none"> • <rss> = received signal strength indication, • <ber> = channel bit error rate. <p>Verify the <rss> value returned using the values below:</p> <table border="0" style="width: 100%;"> <tr> <td style="width: 20%;">Value</td> <td style="width: 20%;">of</td> <td style="width: 20%;">received</td> <td style="width: 20%;">signal</td> <td style="width: 20%;">strength</td> <td style="width: 20%;">indication</td> <td style="width: 20%;">(<rss>)</td> </tr> <tr> <td>0</td> <td>-</td> <td>10</td> <td></td> <td></td> <td></td> <td>Insufficient</td> </tr> <tr> <td>11-</td> <td></td> <td>31</td> <td></td> <td></td> <td></td> <td>Sufficient</td> </tr> <tr> <td>32-</td> <td>98</td> <td></td> <td></td> <td>Not</td> <td></td> <td>defined</td> </tr> <tr> <td>99</td> <td colspan="6">No measure available</td> </tr> </table>	Value	of	received	signal	strength	indication	(<rss>)	0	-	10				Insufficient	11-		31				Sufficient	32-	98			Not		defined	99	No measure available					
Value	of	received	signal	strength	indication	(<rss>)																														
0	-	10				Insufficient																														
11-		31				Sufficient																														
32-	98			Not		defined																														
99	No measure available																																			
AT+CREG?	<p>Used to verify the registration on the network</p> <p>Enter the AT+command " AT+CREG ?" and click " Send "</p> <p>The format of the returned response is as follows:</p> <p>+CREG: <mode>,<stat> with:</p> <ul style="list-style-type: none"> • <mode> = unsolicited registration message configuration, • <stat> = registration state. <p>Verify the state of registration according to the returned value:</p> <p>+CREG: 0,0 Not registered, no registration attempted</p> <p>+CREG: 0,2 Not registered, registration attempted</p> <p>+CREG: 0,1 Yes registered, home network</p> <p>+CREG: 0.5 Yes registered, roaming</p> <div style="border: 1px solid #ccc; padding: 10px; margin-top: 10px;">  <p>NOTE: If a registration is not successful then the cell network provider does not have coverage in this area or the modem is set to the incorrect band for your network provider</p> </div>																																			
AT+COPS=?	Forces the modem to initiate a "network scan" listing the networks in an area.																																			

AT+ Command	Description
	<p>Enter the AT+command " AT+COPS=? " and click " Send "</p> <p>The response will include the identifiers of all networks in an area: Eg. (2,"Telstra Mobile", "50501",2), (2,"Telstra Mobile", "50501",0), (3,"YES OPTUS", "50502",2), (3,"YES OPTUS", "50502",0), (3,"vodafone AU", "50503",2),(3,"vodafone AU", "50503",0),(0-4),(0,2)</p>
AT+COPS?	<p>Used to verify the identity of the network that the WebComm is connected too.</p> <p>Enter the AT+ command " AT+COPS? " and click " Send "</p> <p>The modem will respond with the network identifier to which it is currently connected.</p> <p>Eg. +COPS: 0,0,"Telstra Mobile",2</p>
AT#AUTOBND	<p>Used to enable or disable the automatic band selection at power on.</p> <p>AT#AUTOBND= [value] Set</p> <p>AT#AUTOBND? Read</p> <p>AT#AUTOBND=? Test</p> <p>Value:</p> <p>0 Disables automatic band selection at next power - up.</p> <p>1 Enables automatic band selection at next power -up. The automatic band selection stops as soon as a GSM cell is found (deprecated).</p> <p>2 Enables automatic band selection in four bands (at 850/1900 and 900/1800); differently from previous settings it takes immediate effect. Default: 2.</p> <p>Consult MACE for further details on band selection</p>

Editing/Viewing a WebComm site on the web

1. "**Login**" to www.macemeters.com with your "**User Login**" and "**Password**". Navigate to the "**WebComm**" page.
2. Click on the "**Site ID**" hyperlink on the "**My sites**" tab sheet of the WebComm site you wish to view/edit and you are directed to the "**Site information**" page.

All times shown on this page are site local time.
Your current alarm credit is 48 alarms.

Site ID	Site Description	Latest Record
XCi	MAC Test Bench	2014-11-08 11:48:00

[Back to top](#)

3. The "**Site information**" page is divided into two sections:

Site data

Site data

Download site data	Show latest record	Delete site data
Site ID: XCi		
Site description: MAC Test Bench		
Last record downloaded: 2014-11-07 15:27:00		
Suppress status messages: <input type="checkbox"/>		
Enter start date: 2014-11-07 15:27:01	Enter end date:	
YYYY-MM-DD or YYYY-MM-DD HH:MM:SS Leave blank for all data	YYYY-MM-DD or YYYY-MM-DD HH:MM:SS Leave blank for all data	
<input type="button" value="View site data"/>	<input type="button" value="Download site data"/>	

[Back to top](#)



NOTE: The MACE data server will store up to 500Mb of data per "**Site ID**". When this quota is reached uploads are no longer accepted. Ensure data that you wish to keep is downloaded.

Download site data

1. Enter a "**Start date**" and an "**End date**" (in the required format), or alternatively, just leave the fields blank if you wish to download all available site data. By default, the "**Start date**" is pre-determined by the date of the last record downloaded.
2. Check the "**Suppress status messages**" box if you wish to download only time stamped XCi channel data without the [Status messages](#).
3. Click "**Download site data**", to download the data in the format "**SiteID.CSV**".

4. Click "**View site data**" to view site data as text on your computer screen.



NOTE: When "**View site data**" is used, large data files will not be displayed completely. In that instance a message - "**!DataServer, "Due to size limits not all requested data has been returned."**" will be displayed

Show latest record

1. Click on the "**Show latest record**" tab to view the latest timestamped data record uploaded to the data server from this "**SiteID**"

Site data

Download site data	Show latest record	Delete site data
<p>Timestamp: 2014/11/08 12:24:00</p> <p>Velocity: 0.921 m/s Depth: 0.128 m Flow Rate: 2.966 Ml/day Total: 1.774 Ml</p>		

[Back to top](#)

Delete site data

1. Click on the "**Delete site data**" tab to initiate the data deletion procedure.

Site data

Download site data	Show latest record	Delete site data
<p>Site ID: XCI Site Description: MAC Test Bench</p>		
<p>You are about to delete data for this site:</p> <ul style="list-style-type: none">• Before deleting site data you should make sure it has been downloaded.• MACE makes no guarantees that deleted data will be recoverable from backups.• If backup data is requested and is available a fee will be charged for its retrieval.		
<p>NOTE: This site has additional users that have not downloaded any stored data for this site.</p>		
<p><input type="radio"/> Delete data downloaded by the site owner. Data older than 2014-11-07 15:27:00 will be deleted.</p>		
<p><input type="radio"/> Delete data older than this date: 2013-11-07 00:00:00 Valid date formats (site local time): YYYY-MM-DD or YYYY-MM-DD HH-MM-SS</p>		
<p><input type="radio"/> Delete data newer than this date: 2014-11-08 12:24:00 Valid date formats (site local time): YYYY-MM-DD or YYYY-MM-DD HH-MM-SS <input type="checkbox"/> Force this data to be download again if it is available.</p>		
<p><input type="button" value="Delete site data"/></p>		

[Back to top](#)

2. Check the radio button for the selected data you wish to delete.



NOTE: The first method of data deletion will not be available if no data has been previously downloaded.

Site details

Site details

Site details | Site keys | Site alarms | Site users | Remove site | Alarm history

Last update: 2014-11-08 12:18:53 [Edit site details](#)

Site ID:	XCi
Site Timezone:	(UTC+10:00) Australia Eastern Time
Site Description:	MAC Test Bench
Site Access:	MACE support staff have access to this site. Data from this site can be downloaded directly from the MACE data server.
Oldest data record:	2013-11-07 00:00:00
Last record uploaded:	2014-11-08 12:18:00
Server storage used:	2.4 MB
Device type:	FloPro
Serial number:	123456
Firmware:	V3.06.10
Signal strength:	13
Battery status:	OK
Battery voltage:	12.47V
External voltage:	0.35V

[Back to top](#)

Site Details

The "**Site details**" tab sheet, gives you an overview of the XCi device in the field and its stored records on the database.

Click "**Edit site details**" to change any of the editable details ([Add a WebComm site on the web](#)).



NOTE: The MACE data server will store up to 500Mb of data per "Site ID". When this quota is reached, uploads are no longer accepted. Ensure data that you wish to keep is downloaded.



NOTE: The MACE data server will store data for each "Site ID" for 12 months after upload. After the 12 month period, the data will be scheduled for deletion by the data server. Ensure data that you wish to keep is downloaded. A message will be displayed on the website warning that data will be deleted in due course.

Oldest data record: 2013-11-08 00:00:00 NOTE: This site has data scheduled for deletion that has not been downloaded.

Site keys

Site details

Site details Site keys Site alarms Site users Remove site Alarm history

Device upload configuration

These parameters must be entered into the device configuration before data can be uploaded.

Username: UserName	Edit username in your profile
Site upload key: BLUW-JFPY-E4MC	Change upload key
	Save upload details to a text file

Device download configuration

These parameters must be used when downloading site data directly from the MACE data server. You do not need to use these parameters if you are downloading your data via this website.

Username: UserName	Edit username in your profile
Site download key: There is no download key set for this site	Set download key

Back to top

The "**Site keys**" tab sheet, gives you the authentication details necessary for the XCi device to upload data to the MACE data server, as well as the details for download via a third-party software program.

Should your authentication details be compromised, click "**Change upload key**" to generate a new set.

Site alarms

See [Edit Alarms](#)

Site users

Site details

Site details Site keys Site alarms Site users Remove site Alarm history

Adding a user to a site will allow them to download the site's data.

Enter the email address of the user you wish to add

username@user.com x

Note: The user you are adding must be a registered user of this website.

Add site user

Cancel

Back to top

Under certain circumstances, you may wish to "share" your data with other users. For example, a farm manager may wish his irrigation superintendent to also access site data.



NOTE: ONLY "Site Owners" can "Edit site details", or "Delete site data". ONLY "Site Owners" can add site users.



NOTE: "Site users" MUST be registered users of the MACE website.

1. Click on "**Add site user**" from the "**Site users**" tab sheet.
2. Enter the email address of the user that you wish to add and click "**Add site user**".

Remove site

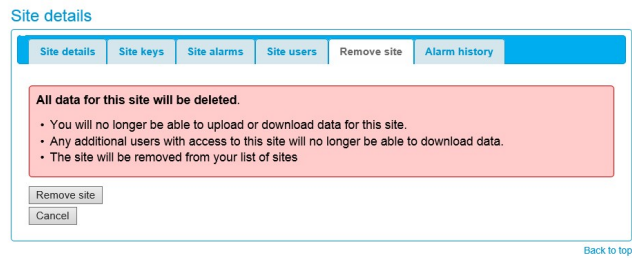

Click on "**Remove site**" from the "**Remove site**" tab sheet.



WARNING: Ensure that you have downloaded all the data that you wish to retain PRIOR to site removal.

[Alarm history](#)

See [Alarm history](#)

All about Webcomm SMS/Email alarms

With the introduction of the MACE WebComm card, the MACE FloSeries3 and/or XCi devices have the ability to upload data to the MACE Data Server on a user-configurable interval for viewing and retrieval on the MACE website (www.macemeters.com/www.macusa.com). The user is also able to configure SMS and email text alarms based on uploaded site data. Some examples:

1. An alarm can be configured based on “**Flow Rate**” to notify the user that a pump has stopped pumping (when the flow rate is zero).
2. An alarm can be configured based on “**Total**” accumulation to notify the user that a certain amount of water has been pumped.
3. An alarm can be configured based on “**Depth**” to notify the user that a river is no longer deep enough for water to be extracted.
4. An alarm can be configured based on “**Rain**” accumulation to notify the user that an amount of rain has fallen.
5. An alarm can be configured to notify the user that their WebComm card has “**stopped**” uploading.

Really, the options for alarm configurations are only limited by the sensor/s that the user has connected to their XCi device.



WARNING: As with any cellphone technology, alarms sent from the MACE Data Server should not be relied upon for “critical” information, particularly in areas with limited cellphone coverage.

Getting started

Follow the instructions for installing a WebComm card ([About the WebComm card](#)) and configuring the card and the website for data uploads ([Add a WebComm site on the web](#), [Configure a WebComm card using FloCom+](#)) In order to configure alarms, the device in the field must be commissioned, and at least one upload must have been received by the MACE Data Server (either from a scheduled upload or one “forced” by FloCom+). This first upload allows the channel structure to be assigned by the data server so that the alarm configuration procedure can be followed.

Enable alarm usage

1. Login to your www.macemeters.com account.
2. Navigate to the “**WebComm settings**” tab sheet in “**My details**”

My details	Mailing lists	Webcomm settings	Change password
Username: UserName			Change
SMS phone number: 6112345678			Change
SMS alarms: Receiving SMS alarms is enabled.			Disable
Email alarms: Receiving email alarms is enabled.			Disable
Alarm credits: 5			Purchase
Auto credit renewal: You have auto alarm credits disabled. If you run out of credit alarms will not be sent.			Enable

- The settings here are used for all Webcomm sites you own, have access to or are configured to send alarms to you.
- The phone number above is used for all SMS alarms that are configured to send messages to you.
- If you disable alarms here **you will not receive** messages from any Webcomm sites.

In this tab sheet, you must:

- a. Enter the SMS phone number at which you wish alarms to be sent.



WARNING: You must enter your full phone number including your country code or SMS alarms WILL NOT work

- b. Enable SMS alarms (if required) by clicking the “**Enable**” link
 - c. Enable Email alarms (if required) by clicking the “**Enable**” link
3. In order to receive alarms (both SMS and email) you must first buy alarm credits by clicking on the “**Purchase**” link and following the directions. If no credit is available on a user account, alarms will be shown in “**Alarm history**” as “**No credit**”. See section on “Alarm history” for further details.
4. “**Enable**” “**Auto credit renewal**” if desired. “**Auto credit renewal**” ensures that alarms can always be sent from your account.
5. Navigate to the “**WebComm**” page and the “**My Sites**” tab sheet will appear listing all your currently configured WebComm Sites.
6. Open the site for which you wish to configure alarms by clicking the “**Site ID**” and the “**Site information**” page will open.
7. In the “**Site details**” area of the page click on the “**Site alarms**” tab sheet

Alarm configuration

1. From the “**Site alarms**” tab sheet, click on “**Add alarm**” and a new alarm can be setup.
2. Select the “**Alarm type**” from the drop-down list and click “**Next**”:

For each alarm type, a form similar to that shown below will appear:

Site details

Site details | Site keys | Site alarms | Site users | Remove site | Alarm history

Alarm description:

Channel to use for this alarm:

Send the alarm when the channel value is **above**: This value triggers the alarm

Clear the alarm when the channel value is **below**: This value clears the alarm

After the alarm has been sent disable it for: This prevents the alarm triggering too often

Send an SMS message to these phone numbers: OK (Test Site)
[Add another phone number](#)
Leave blank for no SMS message.
Use full phone numbers including the international country code.
Only phone numbers for registered users of this website will be accepted.

Limit SMS message size:

Send an email message to these addresses: OK (Test Site)
[Add another email address](#)
Leave blank for no email message.
One alarm credit per email recipient.
Only email addresses for registered users of this website will be accepted.

Message:

Special strings:
[date] Substitutes the date the alarm occurred (YYYY-MM-DD).
[time] Substitutes the time the alarm occurred (HH:MM:SS).
[timestamp] Substitutes the timestamp the alarm occurred (YYYY-MM-DD HH:MM:SS).
[timestamplatestrecord] Substitutes the timestamp of the last record uploaded.
[channelname] Substitutes the name of the channel that caused the alarm.
[channelvalue] Substitutes the value of the channel that caused the alarm.
[channelunits] Substitutes the units of the channel that caused the alarm.
[siteid] Substitutes the site ID the alarm came from.
[sitedescription] Substitutes the site description the alarm came from.

[Back to top](#)

Alarm description:

By default, the description is merely the “**Alarm type**” transposed. However, this description can be changed by the user to something more identifiable if desired.

Channel to use for this alarm:

Using the drop-down list of all the channels in your device that are available, select the channel for which you wish to configure an alarm.

Send the alarm when the channel value is **above/below**:

This is the value of the channel (set point) for which the alarm will be triggered. For example, if you wish to be notified when the velocity of a stream reaches 1m/s , then this is the value to enter here.

Clear the alarm when the channel value is **above/below**:

This is the value of the channel for which the alarm will be cleared. For example, if the stream (example above) triggers an alarm (at 1m/s), then NO further alarms will be sent for this UNTIL the clear point is reached (0.75m/s). After this time, if the stream meets the alarm conditions again, it will trigger a new alarm. See also [After the alarm has been sent disable it for](#):

Add this value to alarm set point each time the alarm occurs:

For a “**Total channel change**” alarm, this is the value that will be added to the alarm trigger point in

order to “re-trigger” the alarm. For example, if an irrigation pump has been started when 0 ML is on the totaliser and you wish to be alarmed whenever there has been 50 ML pumped, the “**Send the alarm.....above**” should be set at 50 and then the “**Add this value....occurs**” should also be set at 50. With this function irrigators can be notified when to shut off pumps/close gates etc.

[After the alarm has been sent disable it for:](#)

When an alarm has been sent, this “**Disable**” function means that the alarm will not be re-sent for the period of time selected from the drop-down list. For example, if the velocity reaches 1m/s and you do not wish to be alarmed again one day, then “**1 day**” would be selected from the drop-down list. If the alarm is cleared (via the “**Clear**” set point described above) and then re-triggered, an alarm WILL NOT be sent again until the one day period is over.

[Send an SMS message to these phone numbers:](#)

Alarms can be sent as SMS messages to mobile phones. An unlimited number of phone number recipients can be added to an alarm. FULL phone numbers including international country code must be entered in the field provided. Leave the form blank if you do not wish to send SMS alarms



WARNING: The recipients of SMS alarms from the MACE Data Server MUST be registered users of the MACE website.

[Limit SMS message size:](#)

When configuring an alarm, the number of credits used to send the particular alarm can be ascertained and limited:

- Each SMS of 160 characters or less = 1 alarm credit per recipient
- Each SMS of 161-306 characters = 2 alarm credits per recipient
- Each SMS of 307 - 459 characters = 3 alarm credits per recipient

[Send an email message to these addresses:](#)

Alarms can be sent as email messages. An unlimited number of email recipients can be added to an alarm. Enter the email address of the alarm recipient in the field provided. Leave the form blank if you do not wish to send email alarms



WARNING: The recipients of email alarms from the MACE Data Server MUST be registered users of the MACE website.



NOTE: Each email regardless of number of characters = 1 alarm credit per recipient.

Message:

Enter in the field provided the message that you wish to be sent (via SMS or email) when the alarm occurs. The default message is:

Alarm from [siteid] at [timestamp].

The [channelname] is [channelvalue][channelunits].

For example, on a mobile phone the message will look like this:

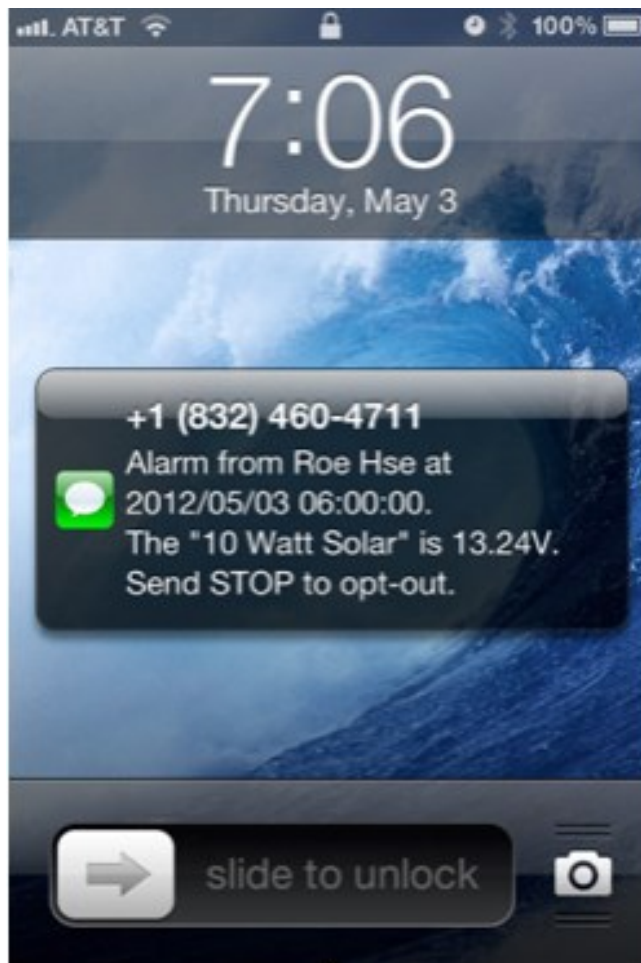



WARNING: For users in USA: Users in the USA will receive SMS messages (like the above) that will give an “Opt-out” option by replying with “STOP”. If this is sent, ALL SMS alarms for ALL sites on the MACE Data Server will be BLOCKED and SMS alarms will cease. MACE recommends setting the phone number +18324604711 as a contact “MACEMETERS” in your cell phone so that you are aware of the SMS origin and do not reply “STOP” by mistake. If SMS alarms have been blocked, the user can send a message “SUBSCRIBE” to the phone number +18324604711 to re-enable.

For example, an email message received will look like this:

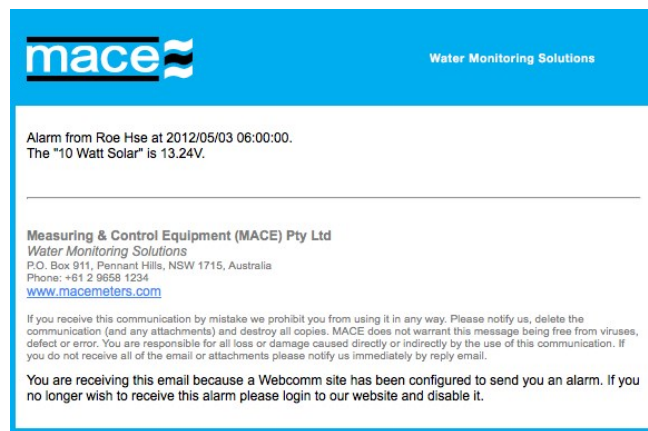

3. Once the alarm has been configured click **“Save alarm details”**.

Alarm state

Once alarms have been configured, the alarms will appear on the **“Site alarms”** tab sheet with their current **“State”**.

Site details

State	Alarm type	Channel name	Set point
Active	Send an alarm when a channel is above a value	Velocity	0.9
Waiting	Send an alarm when a total channel changes	Total	50
Waiting	Send an alarm when a status message occurs		

Back to top

There are four (4) different alarm states:

Active:

The “**Active**” alarm state occurs when the alarm has been triggered. It will stay in this state until the alarm is cleared by reaching the “**Clear setpoint**”. An “**Active**” alarm will have the “**State**” highlighted in a **RED** box.

Waiting:

The “**Waiting**” alarm state occurs when the alarm trigger point has not yet been met. When the alarm set point is reached, the alarm state will change to “**Active**”.

Sleeping:

The “**Sleeping**” alarm state occurs when an alarm has been disabled via the “**After ... sent disable it for**” function (see [After the alarm has been sent disable it for:](#)).

Disabled:

The “**Disabled**” alarm state occurs when an alarm has been permanently disabled via the “**Disable this alarm**” function available when an alarm is edited. See ([Edit Alarms](#)

Edit Alarms

Alarms can be edited after initial configuration by clicking on the hyperlink in the “**Alarm state**” field (such as “**Active**”).

Site details

Site details	Site keys	Site alarms	Site users	Remove site	Alarm history
Alarm details					
Remove this alarm Disable this alarm Edit this alarm Back to alarm list					
Description:	Send an alarm when a channel is above a value				
Channel used:	Velocity				
Send the alarm when the channel value is above:	0.9				
Clear the alarm when the channel value is below:	0.85				
After the alarm has been sent it is disabled for:	1 day				
Number of credits for this alarm:	2				
Message:	Alarm from [siteid] at [timestamp]. The [channelname] is [channelvalue] [channelunits].				

In the “**Alarm details**” information page, there are four buttons that can be used to:

Remove this alarm

Will permanently **remove** the alarm from the site.

Disable this alarm

Will **disable** the alarm from the site without removal.

Enable this alarm

Will **enable** an alarm that had been disabled by the user.

Edit this alarm

Allows the alarm values and recipients to be changed if necessary.

[Back to alarm list](#)

Navigates to previous “**Site alarms**” tab sheet.

Alarm history

The “**Alarm history**” tab sheet provides the user an “audit trail” of the alarms that have been triggered and their recipients for each “**Site ID**”.

Click on the “**Timestamp**” hyperlink for the alarm of choice and jump to the full details of the alarm:

Site details

Site details | Site keys | Site alarms | Site users | Remove site | Alarm history

Alarm event details [Back to alarm history list](#)

Description: Send an alarm when a channel is above a value

Channel used: Temp.

Date set: 2012-05-15 12:00:00

Set point: 21.500 C

Set value: 21.600 C

Message: Alarm from MACDural at 2012/05/15 12:00:00.
The "Temp." is 21.6C.

Credits used: 3

Recipient	Sent to	Status
Mathew Campbell	123456789000	SMS received by recipient.
Mathew Campbell	sales@macemeters.com	Email sent.
Tim Quinlan	123456789111	SMS received by gateway.

[Back to top](#)

The “**Alarm history**” information relates the date/time at which the alarm was set and the date/time it was reset.

The recipient information tells where the alarm was sent (SMS and/or email) and the “**Status**” of the message sent.



WARNING: SMS alarms are sent via an SMS gateway. Status messages are dependent upon the carrier. A status that is “received by gateway” indicates successful transmission by the MACE Data Server. This does not guarantee that the carrier has relayed the SMS alarm to the recipient.

Installing an HVFlo XCi



NOTE: The HVFlo XCi is a waterproof logging flow meter. It has an International Protection (IP) rating of 68 for submergence to a maximum of 3m (10ft). MACE highly recommends that the HVFlo XCi is mounted in an area above known flood levels wherever possible to avoid damage by water ingress.

Installing the HVFlo XCi enclosure

1. The HVFlo XCi should typically be mounted on a railing or ladder-rung using the HVFlo XCi mounting strap (850-407).
2. Locate the HVFlo mounting strap that was supplied with the HVFlo XCi.
3. Open the "**snap-hook**" on one end of the strap.



4. Insert the open end through the mounting hole located on the top of the XCi device and let it "snap" shut



5. Wrap the strap multiple times around the railing or ladder rung.
6. Open the "snap hook" on the free end of the mounting strap.
7. Insert the open end through the mounting hole adjacent to the one to which the other end of the mounting strap is attached and let it "snap" shut.



WARNING: DO NOT put undue weight on the strap (>10kg/22lb). Avoid eye injury. DO NOT overstretch. ALWAYS keep face and body out of recoil path. DO NOT use when strap has visible signs of wear or damage.

9. Let the HVFlo XCi hang loosely.



Connecting a MACE Doppler ultrasonic sensor

1. Unscrew the cap from the Doppler sensor port on the right underside of the HVFlo XCi enclosure.



2. Unscrew the Doppler sensor connector cover off the sensor you wish to plug into the HVFlo XCi



3. Plug the sensor into the sensor port, and screw the retaining ring firmly into place.



WARNING: Ensure that the retaining ring is **NOT** cross-threaded as this **WILL** lead to the HVFlo not maintaining its waterproof rating.

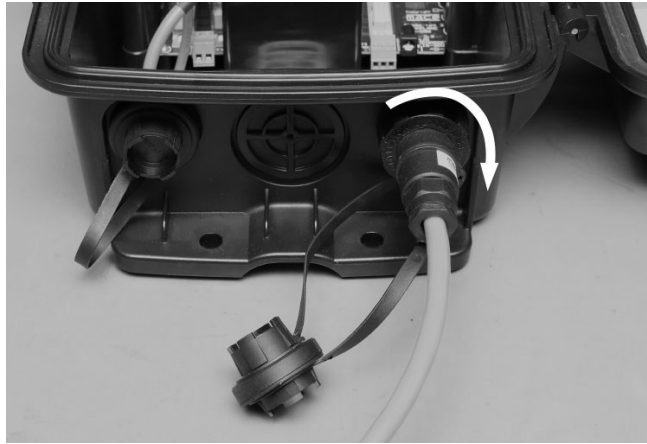

4. Screw the sensor port cap and the sensor connector cover together as shown in the photo above. This will ensure that debris does not enter the threaded section of either cap/cover.

Introduction to FloCom⁺

MACE FloCom⁺ is the software that enables you to communicate, configure and download data from your HVFlo XCi device

System Requirements

Minimum system requirements for PC are:

- Windows® XP
- 10Mb available hard drive space
- USB port
- For many of the functions described in this manual FloCom⁺ Version 3.X.X.X



MACE Software End User License Agreement (EULA)

Users should read and accept the terms of the MACE EULA before installing FloCom⁺ on their PC. The EULA can be found on the downloads page of the [MACE website](#).

Installing FloCom+ Software

Download FloCom+ from our website www.macemeters.com

1. Run the “**FlocomPlus_[version number].exe**” file to start the installation process.
2. Follow the instructions on the welcome screen then click the “**Next**” button to move to the next screen.
3. Choose a location on your computer to install FloCom+. FloCom+ will setup a folder in your program files called “**MACE\MACE FlocomPlus**”. This is the default option. Click the “**Next**” button to continue.
4. Select an Installation Folder. “**MACE FloComPlus**” is the default.

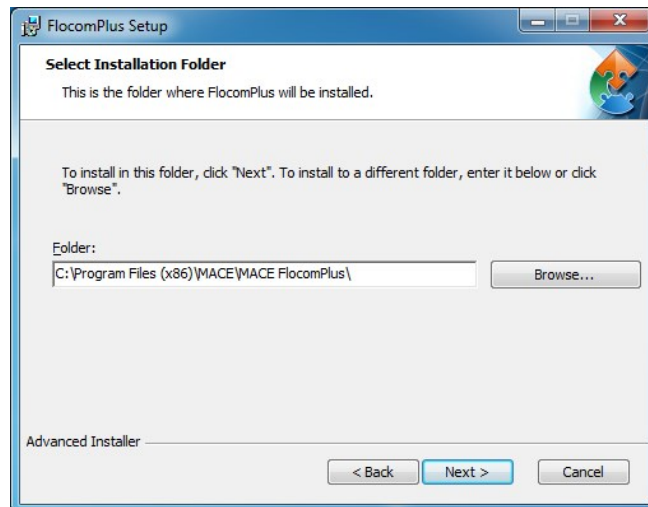

5. Starting installation. Click “**Next**” to begin installing FloCom+.
6. FloCom+ will now install. Once the software installation is complete click the “**Finish**” button to exit the setup program. FloCom+ is now ready to be used.
7. Run FloCom+ using the shortcut provided on your desktop. The startup menu will appear as shown

below. Click **"File>Comms settings..."** to configure FloCom+ for your computer.



Windows XP:

[Download and install](#) the drivers for MACE FloSeries3 - USB external comms lead from www.macemeters.com prior to plugging the cable into a USB port.

Windows Vista/7 & Windows 8:



WARNING: After plugging the MACE comms lead into a USB port, Windows will search for the drivers and automatically download and install on your PC. A connection to the internet is recommended during this phase.



NOTE: If there are connection problems, check the "Troubleshooting" section, I can't "[Connect](#)" to my XCi with FloCom+

8. Check the **"Always use MACE cable if present"** box.

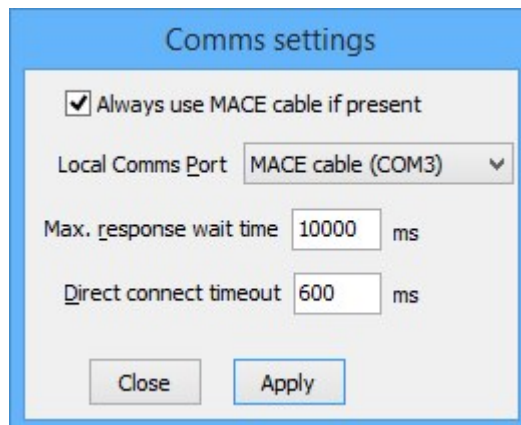

9. If you are not using a MACE USB Comms lead, select the “**Local Comms Port**” of your computer which will be used to communicate with the XCi device when a local connection will be made.



WARNING: If using a USB to Serial adapter please refer to the product documentation supplied with the adapter to ensure the correct driver is installed

10. Click “**Apply**” to save the settings.

Connecting to an HVFlo XCi device

Connecting to the device using the communications port

1. Unscrew the cover from the communications port.
2. Connect a MACE USB Communication Cable (Part No. 850-363) between the USB port of the computer and the communications port of the HVFlo XCi device located on the left underside of the enclosure.



3. With FloCom⁺ running, click "**Connect to Flo3 device**" and the "**Connect to Device**" dialogue will open. Enter the password which has been set in the unit and select "**Continue**". (The default password is **superid**)
4. The main menu of FloCom⁺ that includes the device status summary screen is now visible as shown below.

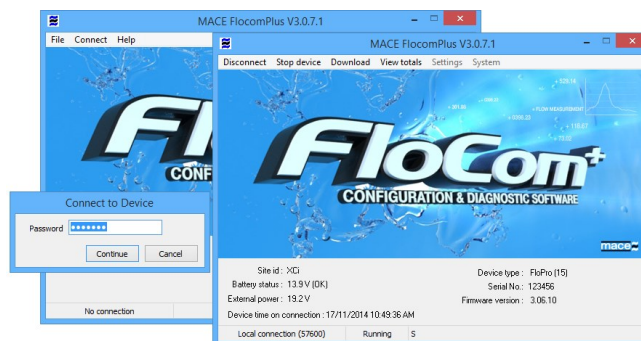

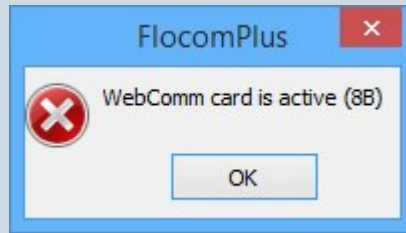

NOTE: If a WebComm card is installed and an upload session is active, you will **NOT** be able to "*Connect*" to the XCi device. In this case an error will occur until the WebComm session is inactive.



NOTE: The device must be configured and started before the instrument will measure and record data



NOTE: Once finished, remove the MACE comms cable and screw the comms port cover back in place to maintain environmental protection

Remote communications with an XCi device

When a MACE WebComm card is [installed and configured](#) in the HVFlo XCi device a remote communications session may be initiated.

1. With FloCom⁺ running, click "**Connect>to remote site**" and the "**MACE Remote Access application**" will open.
2. For further details see [Remote communications with an XCi device](#)



NOTE: The XCi device **MUST** be configured and started via the local communications port **BEFORE** a remote comms session can be initiated.

What to do if the password is lost/forgotten

In the event that you have forgotten or lost your password, the following steps should be taken:

1. From the "**MACE FloCom Plus**" main screen, click "**Help>Show device authorisation code**".
2. Click "**Connect**" and the "**Connect to device**" dialogue box will appear.

3. In this dialogue box the device's unique authorisation code is seen at the bottom

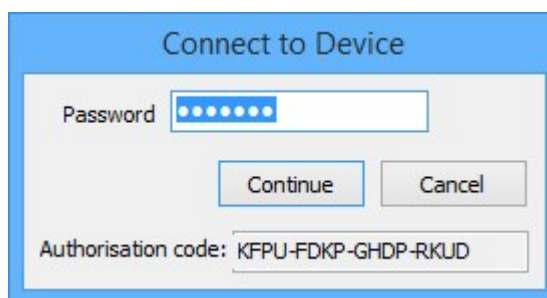

NOTE: You MUST note this code EXACTLY to fulfil the next steps

4. The unique device serial number located on an adhesive label inside the box should also be noted.
5. Once you have noted the code and serial number, you must contact your local MACE dealer/distributor and inform them of these details. They will obtain a "counter-code" for your device.
6. From the "**MACE FloCom Plus**" main screen, click "**Connect**" and the "**Connect to device**" dialogue box will appear.



NOTE: This "counter-code" has a time limit on its validity (typically three days). It must be used to access the unit within this time or it will be void and a new one will need to be produced

7. Enter the 16 character authorisation "counter-code" into the "**Password**" field and click "**continue**". You will now have super user access to the device.



NOTE: You should immediately change the super password to one that will not be forgotten (see [Change super password](#))

Remote communications with an XCi device

Getting ready for a “Remote Access” session

A remote access session utilizes the MACE Data Server (MDS) and the MACE WebComm card in the XCi device as a pass through to send/receive commands from FloCom⁺. In order to initiate a remote access session, you **must**:

- Be running Windows 7 or above
- Have an XCi device running firmware version 3.07.14 or above
- Have a WebComm card running firmware version 1.03.34 or above
- Have FloCom+ version 3.00.10 or above
- [Have a site set up on the MDS](#)



NOTE: To update to the required firmware version see [How to update XCi firmware](#)

Enable a “Remote Connection” in the WebComm card

After ensuring that the correct firmware versions are uploaded into the XCi device, the user must ensure that the WebComm card has been enabled for a “**Remote Connection**”.

1. Click on **Settings>Webcomm>**
2. Ensure that your WebComm card has been [configured correctly](#).
3. Check the “**Enable remote connection**” checkbox in the “**MACE Server**” details section

MACE Server

URL http:// data.macemeters.com

User name UserName|

Upload key •••••••••• Enable Remote Connection

4. Click **Apply** then **Exit** to return to the “**Device Settings**” dialogue box.

Run a WebComm “Forced Upload”

To ensure that the MDS recognizes that a site is using firmware versions capable of a remote access session, you should first initiate a “forced upload” using the “[WebComm utility](#)”.

1. Click on **Settings>Webcomm utility>Start upload**
2. Ensure that an “**RHS: Connecting to server**” message is received from the MDS.

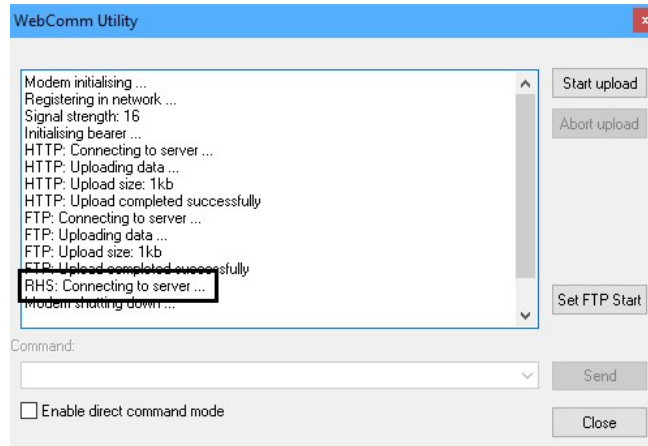

3. **Close** the **WebComm utility**
4. Make any necessary changes to the XCi device by **Edit settings**:
5. **Start** the device and **Disconnect**

Connect to an XCi device remotely



NOTE: A remote access session will only be available ONCE per upload period. That is, it will take the server nominally the time of one upload period to be able to initiate a remote access session. For example, if an XCi device is uploading to the MDS every hour, the user will need to “wait” for up to an hour in order to gain remote access.

1. In FloCom+ **Connect>to Remote site**

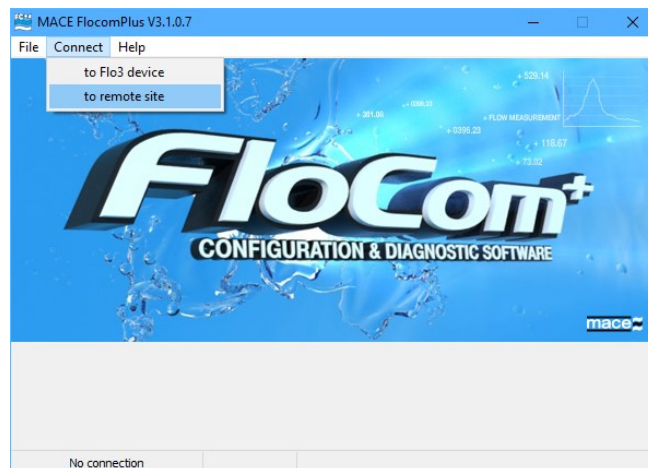

2. The **MACE Remote Access Utility (MRAU)** will start.
3. Enter your **MACE User Authentication** credentials.



NOTE: These are the credentials that you use to Login to view your MACE WebComm site data

MACE User Authentication

data.macemeters.com

User name
User@YourEmail.com

Password
••••••••

Remember password [Register](#)

OK Cancel

4. The MRAU will populate a list with the sites that can be accessed remotely

The **Next Wakeup** column tells the user how long it is until the WebComm card at the **Site name** is scheduled to send an upload. When remotely accessing the XCi device, the MRAU must “tell” the WebComm card to stay “awake” in order to initiate a remote access session.

Name	Description	Status	Next Wakeup
C46	CAIDD site with MSB Sensor and Standard 850-052	Disabled	20 min
Fresno	Fresno State Pump Site	Waiting	29 min
XCi Test	MAC Test Bench	Waiting	Less than 1 min

Name: Mathew Campbell Company: MACE

- Right-click on **the Site name** and **Request Remote Host Comms Session**. If you wish to be notified by SMS/Email click on **Request Remote Host Comms Session with Notifications**.

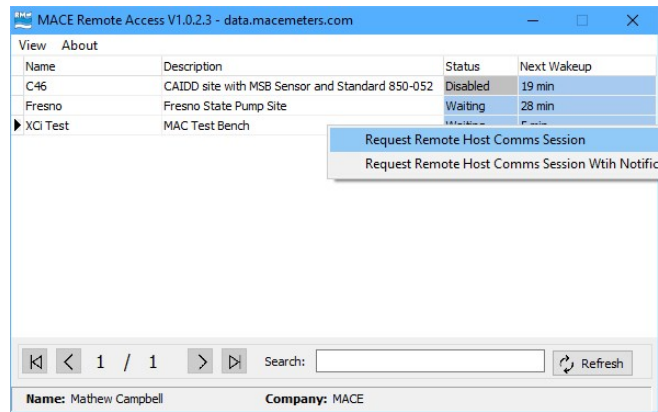

NOTE: You will only be notified by SMS/Email if you have enabled "[Alarms](#)" and have sufficient alarm credits.

- The **Status** will change to "**Requesting**" and the "**Next wakeup**" time will countdown. When the Remote access session can be used, the status will change to **Ready**

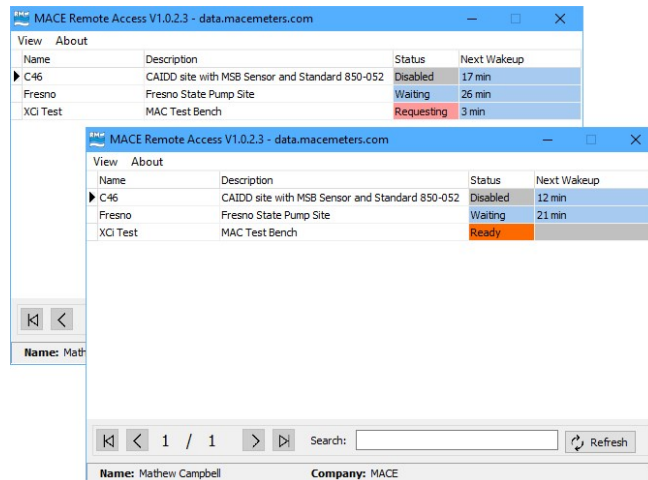

7. Right-click on **the Site name** and **Request Enter Host Comms Session**.

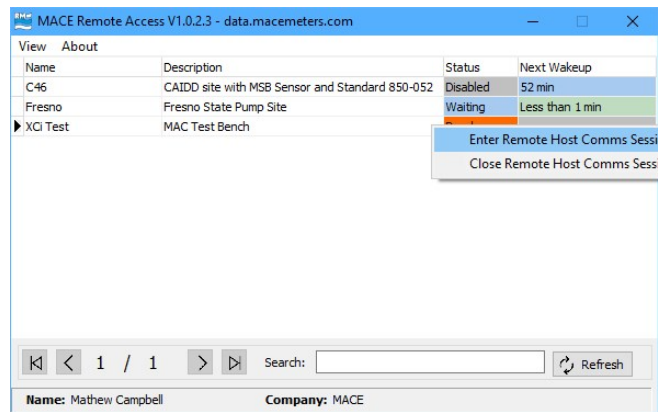

After a short period where the remote comms session is being connected to the device, FloCom+ will prompt for the XCI device password to be entered as usual.

8. Since during a remote session, FloCom+ is talking to the XCI device via the MDS, there may be a noticeable lag between sending a command and receiving a response. In this case, FloCom+ will give the user an indication that communications are being established.

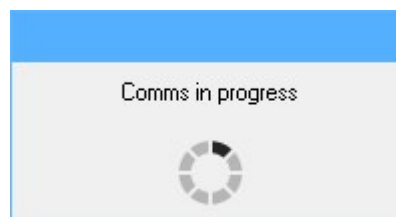

Normal communications can now be undertaken using FloCom+ as usual. The majority of functionality that can be accessed when using a local connection with FloCom+ may also be accessed during a remote session, however, certain functionality may be restricted. For example, making changes to certain Webcomm settings.



NOTE: Should the user (and therefore the connection) be inactive for 15 minutes, a warning will appear in the Windows Notification centre and on the screen of FloCom+. If no action is taken, the XCI device will be **Started** with it's last **Applied** settings and **Disconnected** from the MDS.

When the remote session is completed, simply **Start** the device and **Disconnect** from the unit. The MRAU will prompt for the session to also be closed with the MDS. If you answer **No**, the remote session will return to the **Ready** state.

Right click on the **Site name** to **Enter** a new session or **Close** the session

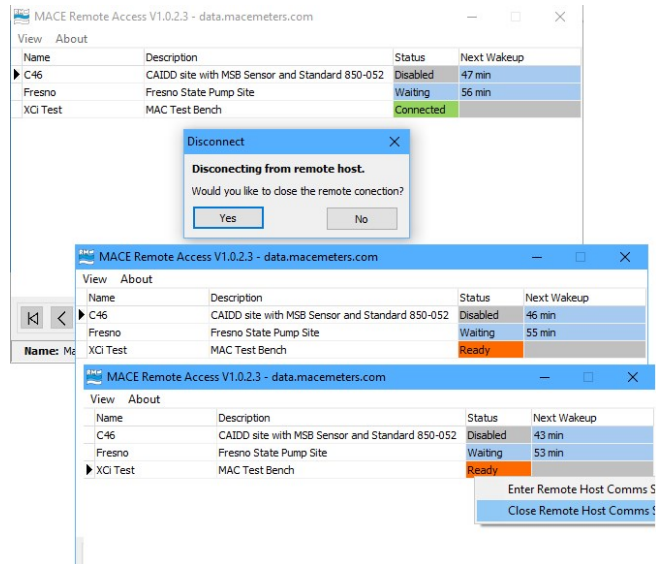

9. The host comms session will be closed and the FloCom+ main screen will be seen.

FloCom+ - The essential steps to configuring an HVFlo XCi device

Before an HVFlo XCi device can be used, it must be "configured" for operation. This entails a knowledge of the field application and what you wish to measure.

For example, if you wish to measure flow rate in a partially-full pipe and totalise that flow, four parameters (known as "**Channels**" in an XCi), will need to be added and configured:

- **Velocity channel**- The velocity of the stream flow in the pipe must be measured
- **Depth channel** - The depth of the stream flow through the pipe must be measured
- **Flowrate (using velocity) channel** - The flow rate of the stream is calculated from the measured velocity and multiplying by the cross-sectional area of the pipe (calculated from the depth of the stream and the pipe size)
- **Total channel** - The total is calculated by multiplying the flow rate, by a time period

With a knowledge of the application and what parameters need to be measured, the XCi device can be configured for use in a few simple steps. The procedure is structured in a logical sequence so that the device is configured in the correct order.

1. From the main menu click "**Settings**" and the "**Edit configuration settings**" dialogue box will appear as shown.

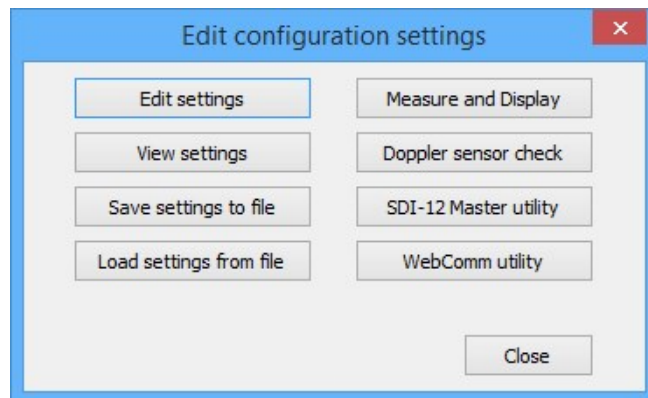

2. Click "**Edit settings**" and the main "**Device Settings**" dialogue box will appear.

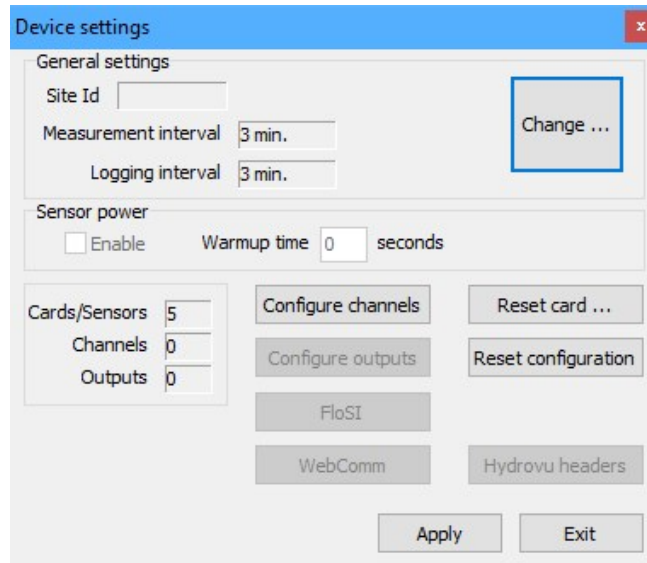

Edit general settings

1. The first step is to edit the "**General settings**".
2. From the main "**Device Settings**" dialogue box click "**Change**" and the "**General Settings**" dialogue box will appear as shown.

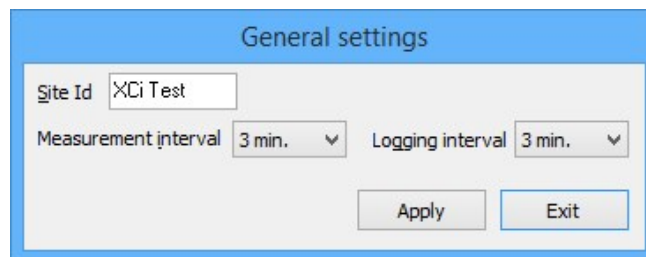

3. Type in a "**Site ID**"

Site ID

The "**Site Id**" is a text field used to identify the location of the device. When data is retrieved from the device, it will be identified by this name. For example, the "**Site Id**" might be the name of the treatment plant or license number.



NOTE: The instrument's "**Site Id**" is required before the configuration can be applied successfully

4. Select a "**Measurement interval**" and a "**Logging interval**" from the drop-down list boxes.

Measurement and Logging interval

The measurement interval is the time at which the device 'wakes up' to measure/calculate the values on each of the configured channels. Data is logged in the data file ONLY at the logging interval. The measurement interval will always be shorter than or equal to the logging interval. In the case of the measurement interval being shorter than the logging interval, then the data logged will be the average of those values calculated per measurement interval.



NOTE: The measuring and logging intervals available, are affected by other settings in the XCi configuration: eg. integration time and sensor power. The XCi will always warn the user of the implication of changing a setting that impinges on these intervals.



NOTE: The logging interval can only be a multiple of the measuring interval.

5. Click "**Apply**" and the main "**Device Settings**" dialogue box will re-appear.

Add XCi channels

As described in the introduction to this chapter, a knowledge of the field application and what you wish to measure is essential to the successful configuration of the HVFlo XCi device

1. From the main "**Device Settings**" dialogue box click "**Configure channels**" and the "**Configure channels**" dialogue box will open.

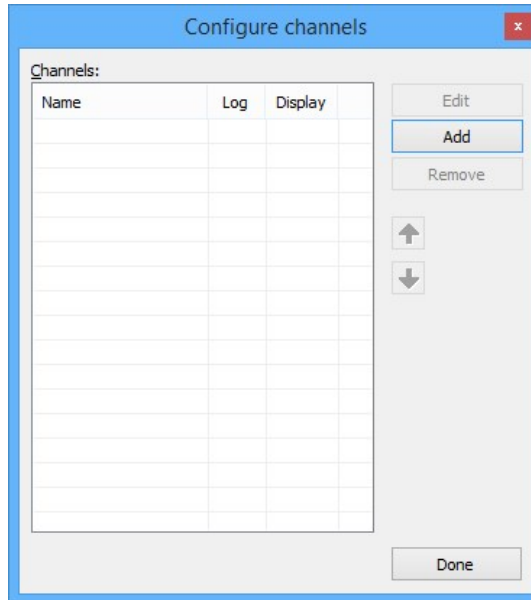

2. Click "**Add**" and the "**New channel**" dialog box will open to allow the selection of a "**Channel type**" to add.

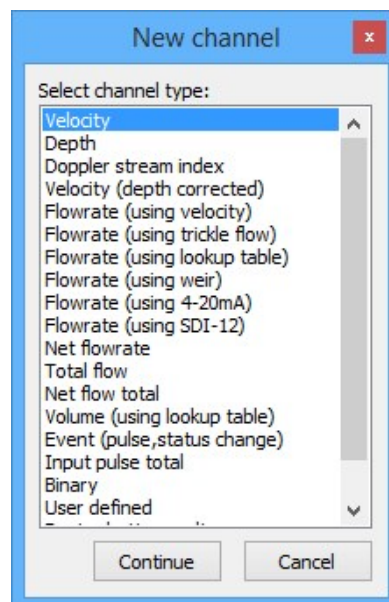



NOTE: The “*Channel types*” visible in the “*New channel*” dialogue box are dependent upon the cards that have been installed in the HVFlo XCi device.

3. Select the “*Channel type*” that is required and click “*Continue*”. The “*Channel name*” dialogue box will appear. Enter a channel “*Name*” in to the text field (16 character maximum). Click “*Continue*”.
4. In the “*New channel - Select card*” dialogue box that appears, select the FloSeries3 card (and physical input, see [XCi Input Types](#)) from which the named channel will receive its value. (If a Doppler card is selected, a further configuration step is required see [Doppler Card - Velocity channel type](#)



WARNING: Each MACE card available is referenced in the list by its type and slot number. (eg. Doppler card @ 1). ALWAYS ensure that the appropriate card in the correct slot is selected. This is particularly the case when multiple cards of the same type are inserted in the HVFlo XCi device.

5. Click “*Continue*” to complete the new channel. The “*Configure channels*” dialogue box will re-appear with the new channel listed.

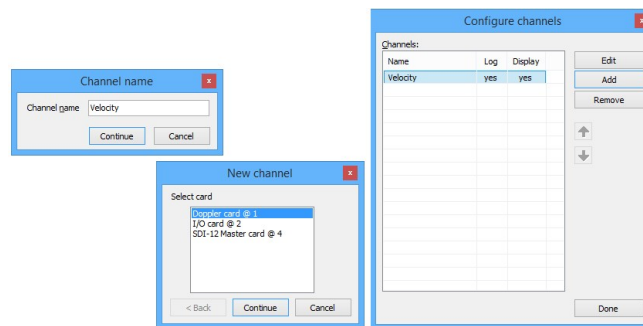

NOTE: As a particular card’s input becomes fully utilised the card will not appear on the “*Select card*” list.

Edit XCi Channels

Once the required channels have been added, they must then be edited to ensure that the measured values are meaningful.



WARNING: All configured channels MUST be edited prior to starting the XCi device. Editing the channel/s enables the correct configuration information to be sent to the controller module.

1. From the main "**Device Settings**" dialogue box click "**Configure channel**" and the "**Configure channels**" dialogue box will appear.
2. Highlight the channel you wish to edit and click "**Edit**". A channel specific "**Edit channel**" dialogue box will appear.
3. Edit the settings in the "**Edit channel**" dialogue box to suit your application as per the recommendations in [XCi Channel Types](#). In all cases, the "**Edit Channel**" dialogue box provides information of:
 - "**Channel path**" - This describes the channel type and the card input source.
 - "**Channel name**" - This is the name given to the channel by the user when [added to the configuration](#).
 - "**Decimal places**" - The user can set the number of decimal places (0, 1, 2, 3) using the drop down list box. Data can be logged with these decimals in the data file .

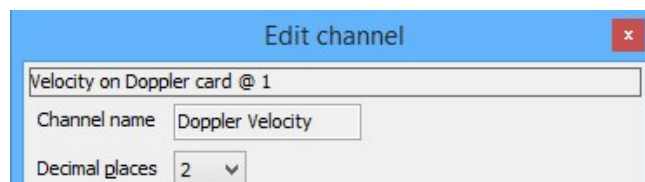

4. Click "**Apply**" to save the settings and return to the "**Configure channels**" dialogue box.

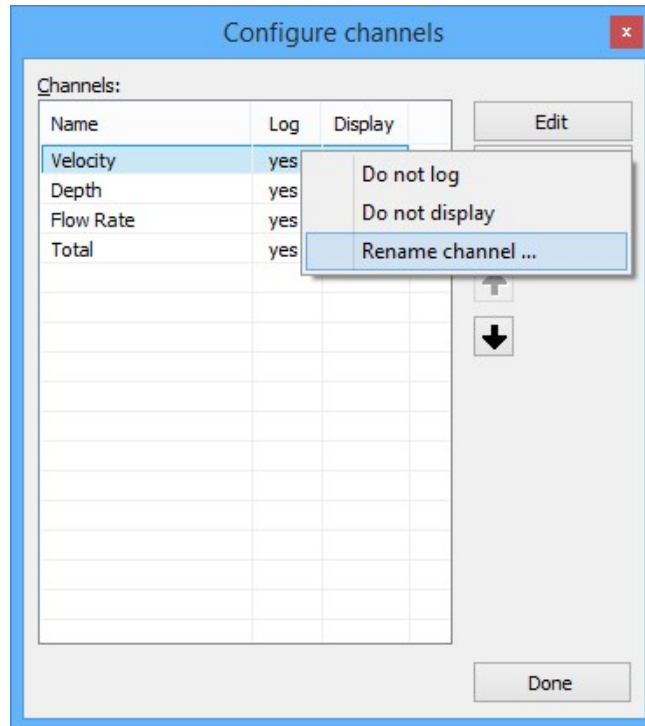

NOTE: A channel name can only occur once in a configuration. If a channel is given the same name as an existing channel, FloCom+ will give an error message



WARNING:

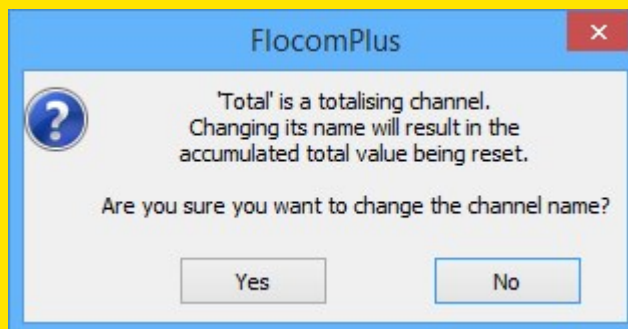

Renaming a Total "*Channel Type*", will necessitate the totaliser being reset. FloCom+ will give a message to warn of this behaviour.

Setting logging attributes for channels

Under certain circumstances, it may be desirable to log only the values from certain channels of an XCi configuration. For example, when logging a flow rate and accumulated total that is calculated from a velocity and a depth measurement in a partially-full pipe, the user may decide that only the flow rate and totaliser channels will be logged.

1. Simply highlight the channel name that is to have the logging attribute set to "**yes**" or "**no**", right-click on the highlighted channel and select "**Do not log**" or "**Log channel**". Once the attribute has been set, it will appear in the "**Configure channels**" dialogue box.

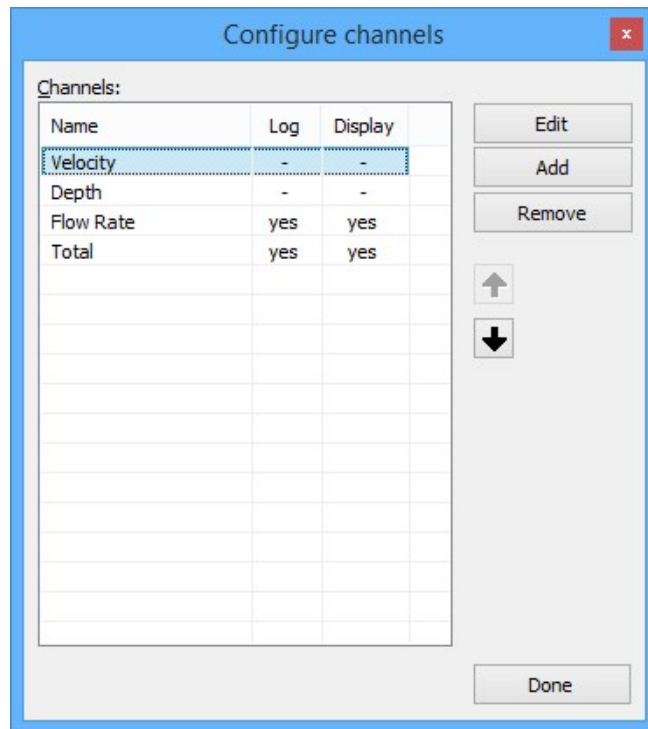

Removing configured channels

1. Highlight the “Channel” in the list you wish to remove and click “Remove”.



NOTE: The removal is hierarchical and certain limitations apply. A “*Channel*” that is referenced by at least one other “*Channel*” cannot be removed unless the dependent “*Channel*” is also removed first.

2. If dependent channels also require removal, accept the change by clicking “**Remove**”.

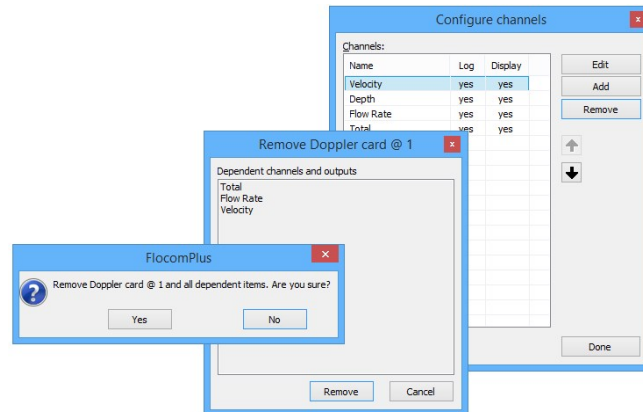

Reset card/configuration

Reset card

This function enables the user to remove a configured card and all its associated channels.

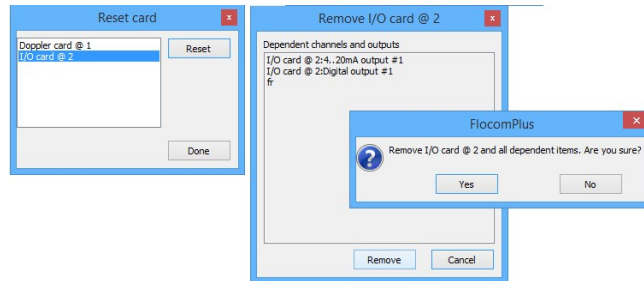

WARNING: Use "Reset card" with care

Reset configuration

Clicking "**Reset configuration**" causes all configured modules, channels and outputs to be removed.

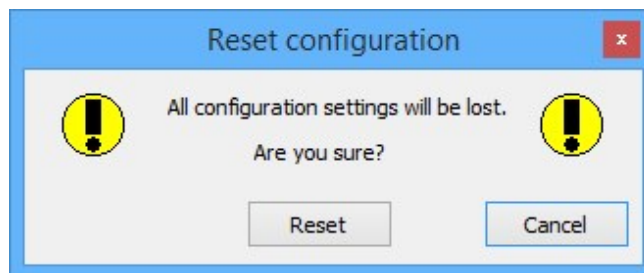

WARNING: Use "Reset configuration" with care

The File menu

These functions are accessed via the "**File**" menu from the "FloCom+ **Home screen**" and then selecting the related option.

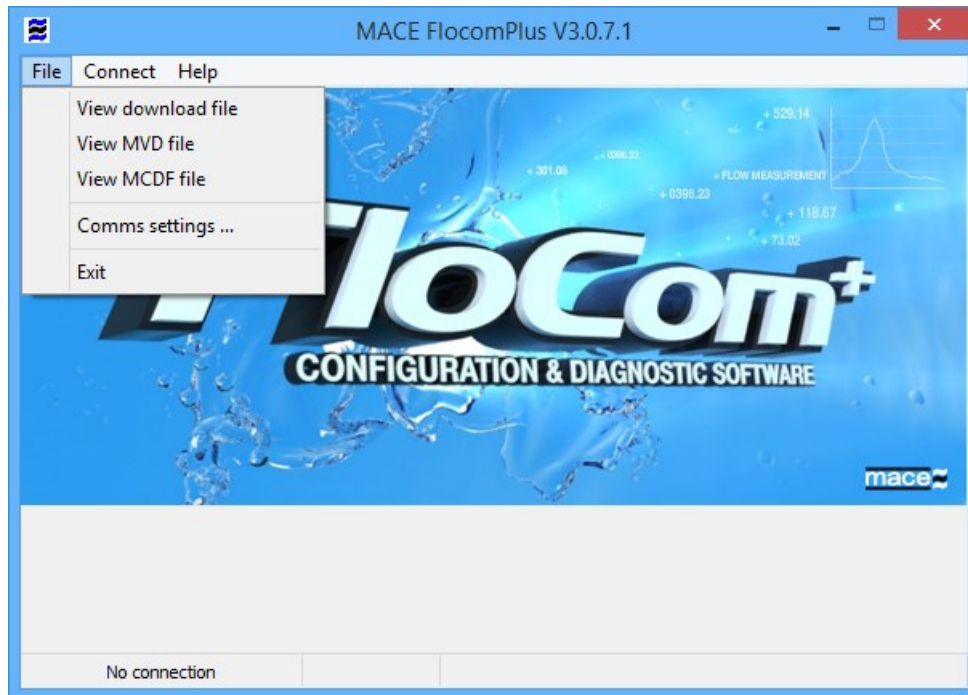

NOTE: The "**File**" menu is only available when not connected to the HVFlo XCi device

[View download file](#)

[View MDCF file](#)

[View MVD file](#)

[Comms settings](#)

View download file



NOTE: MACE Download files are saved as CSV files

Opening a file

On entry, an open file prompt window is displayed. If downloaded data was saved during the current session, the last downloaded data file appears as the default selection. On selecting “**Open**” the selected file is loaded and if successful the data is displayed as a text file. A different downloaded data file may be selected at any time by selecting the local “**File**” function and repeating the file selection procedure.

Viewing a file

Time stamp tree view

This pane enables the user to quickly navigate the data file by date and time. Expand the tree on the date of interest to reveal the various time stamps. Click the time stamp you wish to view and the data file will automatically scroll to it.

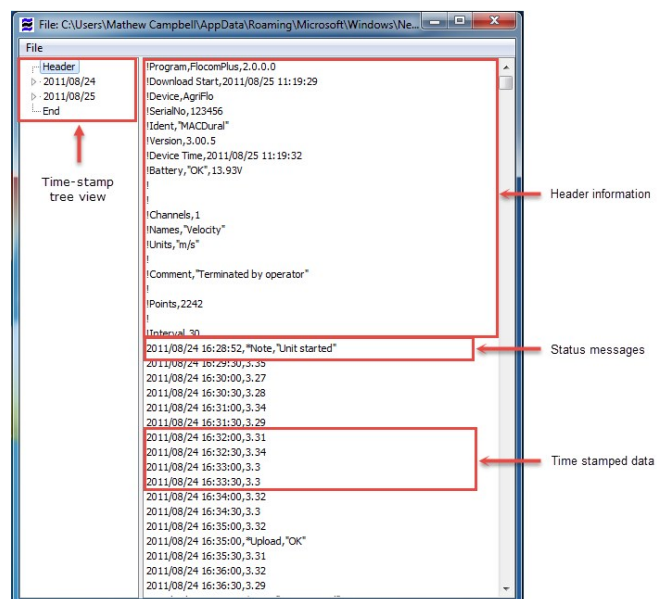

Header information

At the top of each data file the following information is displayed:

- Version of FloCom⁺ used to download the file;
- Time and date the data was downloaded to the PC;
- Device type; HVFlo XCi device;
- Serial number of the XCi device;

- Version of firmware installed in the XCi device;
- Time and date of the clock in the XCi device;
- Battery status and charge (voltage) of the XCi device;
- Number of channels being recorded;
- The names of each channel being recorded;
- The units of measure used for each channel being recorded;
- 'Points' refers to the number of data lines in the downloaded file;
- 'Interval' refers to the time in seconds between each time stamp (logging interval).

Status messages

Status messages are defined by the use of an asterisk (*) immediately following a time stamp. For example, in the download image above the following message appears which tells the user the date and time the unit was started.

2011/08/24 16:28:52, *Note, "Unit started"

Table of Status messages

Status message	Description
Unit Started	Device was started
Unit stopped	Device was stopped
No external power	No external power was detected. If a solar panel is used this will occur at sunset
External power restored	External power is detected. If a solar panel is used this will occur at sunrise.
Low Battery	Time at which battery voltage fell below 11.5V
Battery normal	Time at which battery voltage exceeded 11.5V
Flat battery condition	Battery voltage at download time is less than 10V
Battery was flat	Battery was less than 10V
Sensor not detected	MACE Doppler sensor not detected
Sensor error	Any configured module not detected
Device reset #0*	Power up reset occurred. Generally occurs when the battery has been changed without first " Stopping " the unit
Device reset #1*	Clock reset. Generally occurs if a command line error occurs when

Status message	Description
	talking to the Real-time clock (RTC).
Device reset #2*	May occur between "Low battery" and "Flat battery" under certain conditions.
TOD clock error*	Error reading time-of-day clock
Upload "HTTP OK"	A successful HTTP upload was made to the MACE data server
Upload "FTP OK"	A successful FTP upload was made to an FTP data server
Upload timeout	An unsuccessful upload attempt was made
Upload bearer error	The WebComm card was unable to establish a bearer connection and an unsuccessful upload attempt was made
Terminated by operator	The download was aborted by the user
Incompatible session/s skipped	The download includes only data since the last channel re-structure



NOTE: * - These messages are NOT symptomatic of a unit failure. Rather, they are a sign that the XCi has dealt with a potential problem internally.



NOTE: For further "WebComm" related status messages, see [Error messages table](#):

Time stamped data

At each time stamp the date, time and recorded channel values are shown. The date and time are followed by the recorded values for each of the configured channels. In the popup above, the configured channel is "**Velocity**" and it's time-stamped values include:

2011/08/24 16:32:00, 3.31

2011/08/24 16:32:30, 3.34

2011/08/24 16:33:00, 3.3

2011/08/24 16:33:30, 3.3

End of file

The end of the data file is always delineated by a "**Download End**" followed by the date and time.

View MVD file



NOTE: MVD Files - MACE Velocity Data File

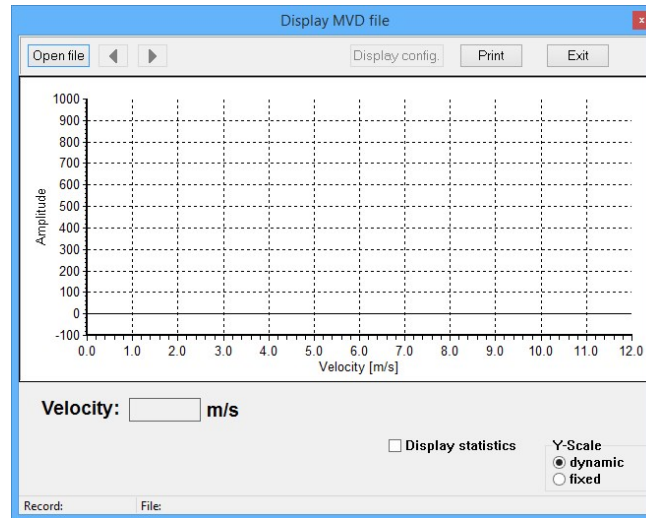

Click "**Open file**" and an open file prompt window is displayed. If MVD file/s were saved during the current session, the last saved MVD file appears as the default selection. On selecting "**Open**" the selected file is loaded and the MVD file is displayed. A different MVD file may be selected at any time by selecting the local "**Open file**" function and repeating the file selection procedure.

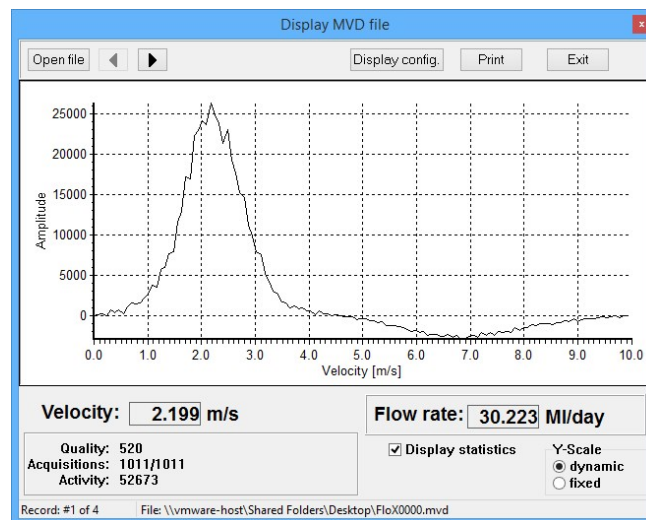

If more than a single "**Real-time graph**" was saved, the "**Arrow**" buttons



may be used

to cycle forward/reverse through the saved graphs. The "**Print**" button may be used to send the "**Real-time graph**" to a printer.



NOTE: See "[Doppler sensor check](#)" and [interpreting real-time data](#) for further details.

The configuration of the Doppler card/sensor associated with the saved "**Real-time graph**" can be viewed by clicking "**Display config.**". The "**Print**" button may be used to send the "**Display config.**" to a printer.

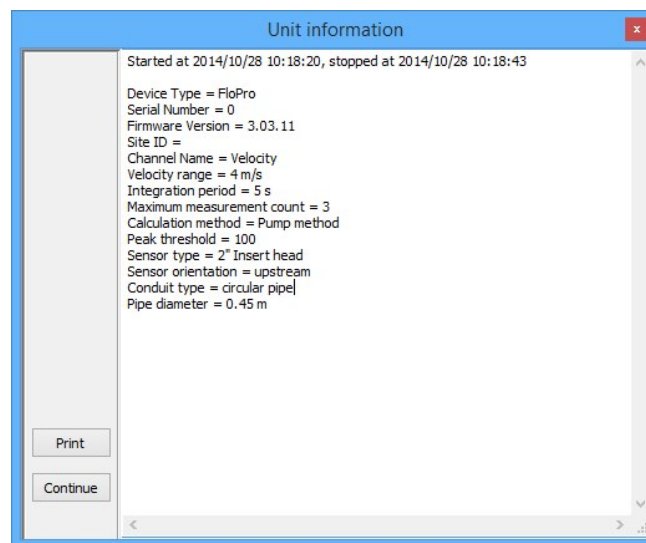

View MDCF file



NOTE: MDCF Files - MACE Data Configuration File

The "**Select configuration file**" prompt window is displayed. If MDCF file/s were saved during the current session, the last saved MDCF file appears as the default selection.

On selecting "**Open**" the selected file is loaded and the MDCF file is displayed showing a tree view of all configured cards and their respective sensors and measured channels.. A different MDCF file may be selected at any time by selecting the local **New file**" function and repeating the file selection procedure.

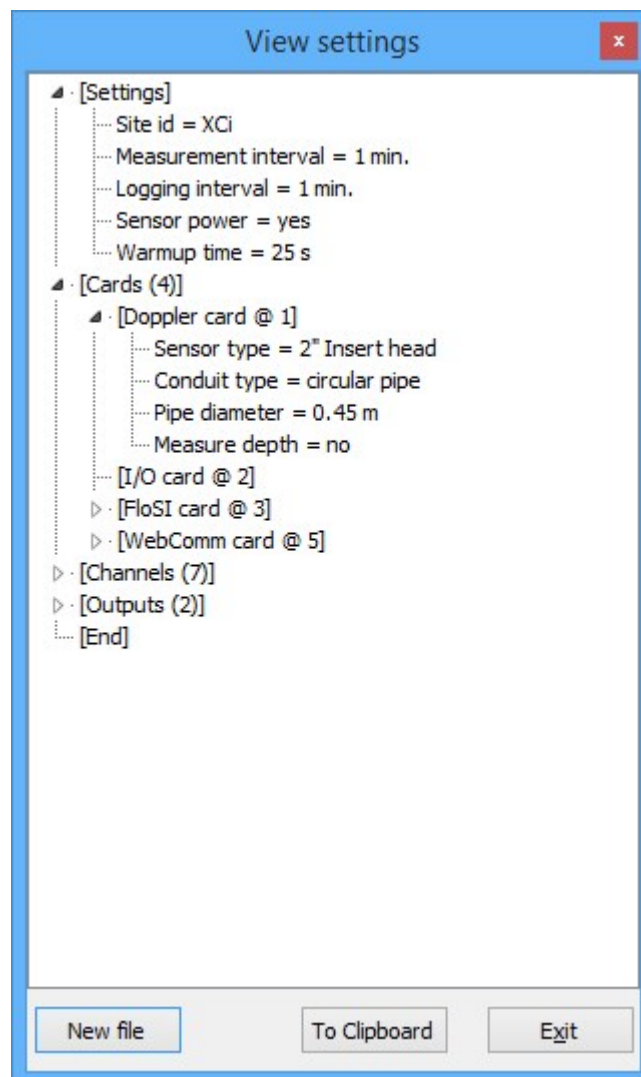

Comms settings

The "**Comms settings**" dialogue box will open

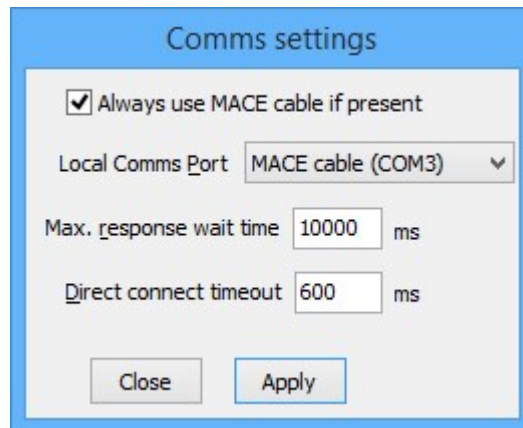

NOTE: MACE recommends using a MACE USB Communications cable (Part No: 850-363) for ease of use

1. Check the "**Always use MACE cable if present**" box and FloCom+ will automatically find and use the appropriate settings.
2. Click "**Apply**" to return to the FloCom+ "**Home screen**" where the "**Connect**" menu item is located.

See [Installing FloCom+ Software](#) and [Connecting to an HVFlo XCi device](#) for further details



WARNING: If using a USB to Serial adapter please refer to the product documentation supplied with the adapter to ensure the correct driver is installed

The Main Menu

Upon "**Connecting**" successfully to the HVFlo XCi device the "**Main menu**" will display as shown.



The system area of the "**Main menu**" contains information about the XCi device that is connected:

Site id:

The "**Site Id**" is a text field used to identify the location of the device.

Battery status:

Provides a value in V(olts) of the main battery when connected to the device.

External power:

Provides a value in V(olts) of the external power source when connected to the device.

Device time on connection:

The date and time on the XCi device real-time clock when the connection with FloCom+ was made.

Device type:

The XCi device type; AgriFlo, FloPro, HydroMace or HVFlo.

Serial No:

The internal electronic serial number of the device

Firmware version:

The firmware version (operating software version) of the XCi device controller card.

Disconnect

From the main menu click "**Disconnect**" and you will be asked "**Are you sure?**". Click "**Yes**" and the HVFlo XCi device will be disconnected and you will be returned the start up menu. Click on "**File>Exit**" to shut down FloCom⁺

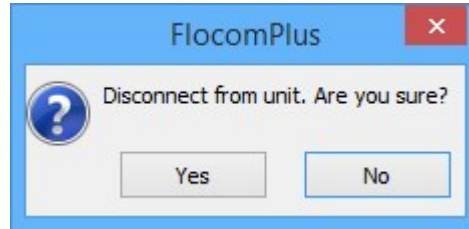

WARNING: If FloCom⁺ is not disconnected from the HVFlo XCi device excess current will be drawn from the main battery.

Download

From the main menu, click "**Download**" to initiate the stored data download procedure. A save file dialogue box will appear.

The default file name is the unit ID. The default target directory is the directory into which the previous download file was stored.

Click "**Save**" once you are ready to download the device. The "**Download**" dialogue box will appear which shows the amount of stored data in the device and the date of the earliest available record. If the download end time is left unchanged or set to a time earlier than the earliest record, all stored records will be downloaded. Otherwise, only those data stored after the chosen "**Download from**" date will be downloaded.

Click "**Start download**" to complete the download procedure.

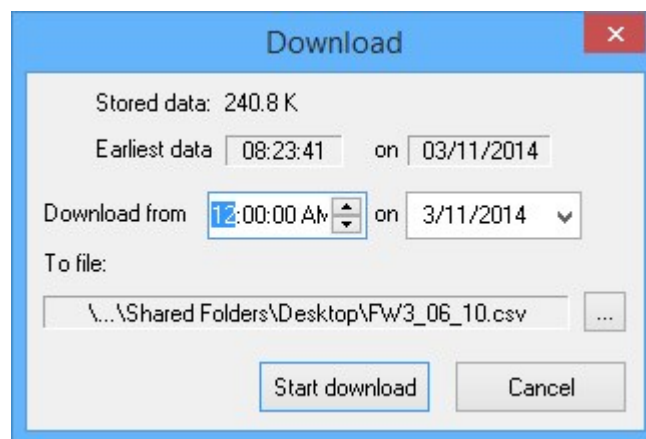

WARNING: Adding a new channel creates a new data session. It is essential to download the data from the XCi device **PRIOR** to adding new channels to an HVFlo XCi device that has already been configured and has had data recorded.

For further information about the downloaded data file [View download file](#)

Settings

From the main menu click “**Settings**” and the “**Edit configuration settings**” dialogue box will appear as shown.

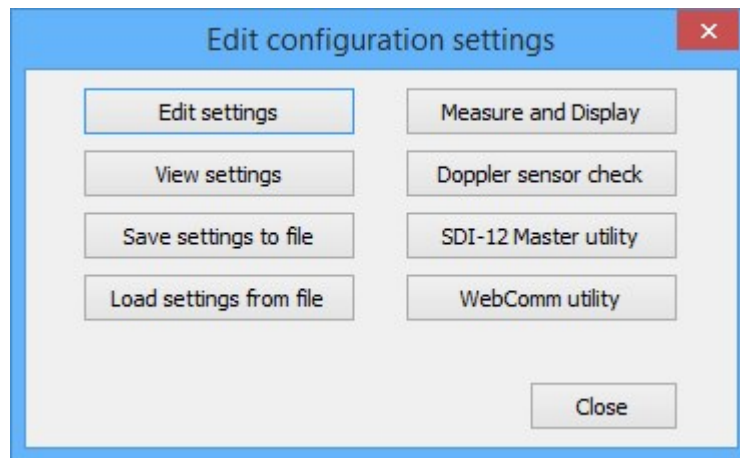

NOTE: Menu items may be "greyed out" depending upon the FloSeries3 cards physically installed.

Edit settings

Click “**Edit settings**” and the main “**Device Settings**” dialogue box will appear. The procedure for configuring an XCi device is structured in a logical sequence so that the device is configured in the correct order.



WARNING: For further details see [FloCom+ - The essential steps to configuring an HVFlo XCi device](#)

View settings

By clicking “**View settings**” from the “**Edit configuration settings**” dialogue box the user is able to see a tree view of all configured cards and their respective sensors and measured channels.

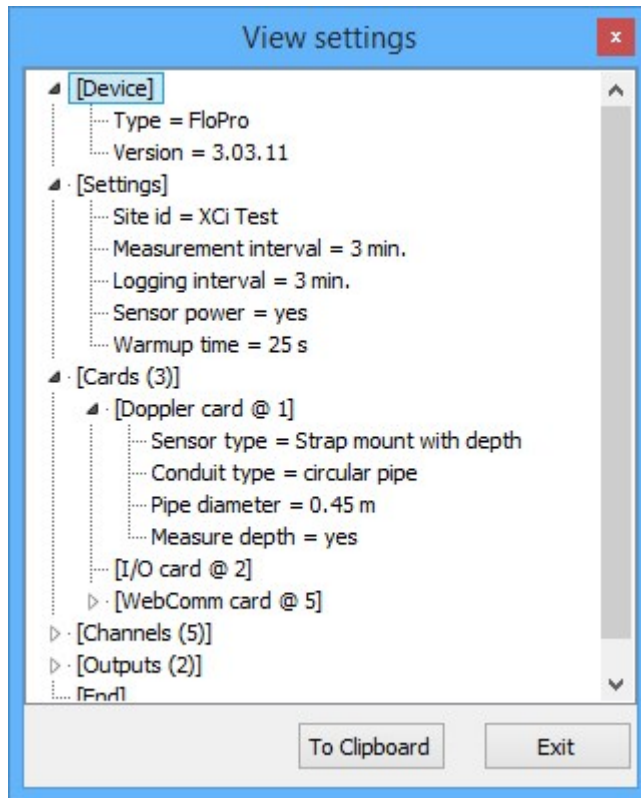

By clicking "**To Clipboard**" the user can then paste the tree view into any text document.



NOTE: There is no tree view available until at least one channel is configured.

Save settings to file

Clicking "**Save settings to file**" from the "**Edit configuration settings**" dialogue box allows the user to save a MACE Data Configuration File (MDCF) for later viewing and/or loading into another XCi device.

Load settings from file

A previously saved MDCF file can be loaded into an HVFlo XCi device by clicking on "**Load settings from file**". The "**Select configuration file**" prompt window is displayed. If an MDCF file was saved during the current session, the last saved MDCF file appears as the default selection. After selecting the required configuration file, click "**Open**" and the file will be loaded into the HVFlo XCi device.



NOTE: If a configuration file for an HVFlo XCi device contains cards that are not available, or in different slot numbers than the XCi device into which you are trying to load the file, then the loading procedure will attempt to "Cleanup" the configuration. The following steps may be necessary:

1. From the "Load configuration" dialogue, note any "Configuration discrepancies" and assess whether or not they are to be expected. If not, a particular card may need to be re-installed (see [Installing FloSeries3 Cards](#))

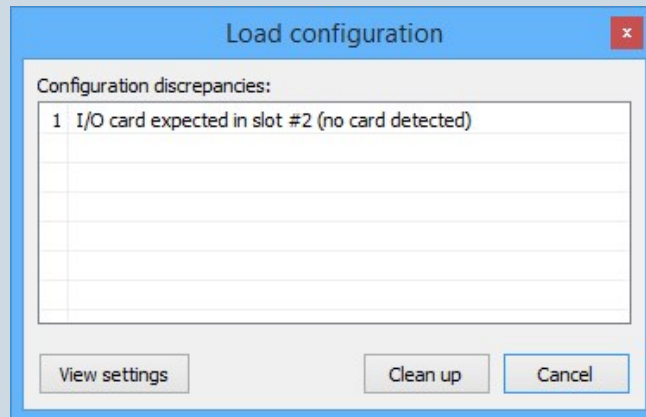

2. Click on "Cleanup" and the "Missing cards" dialogue will ask whether you wish to remove the missing cards. After verification, click "Remove"

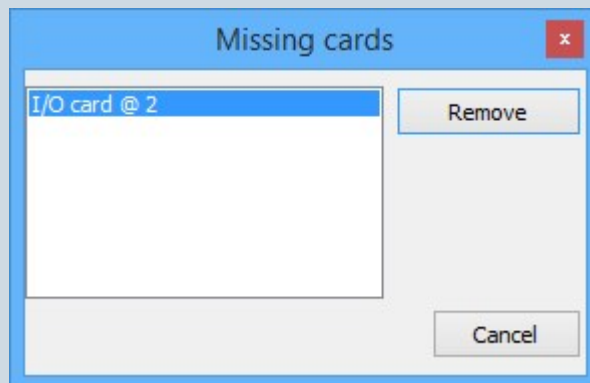

3. Any "Dependent channels and outputs" will be listed. After verification, click "Remove" again and you will be asked "Are you sure?"

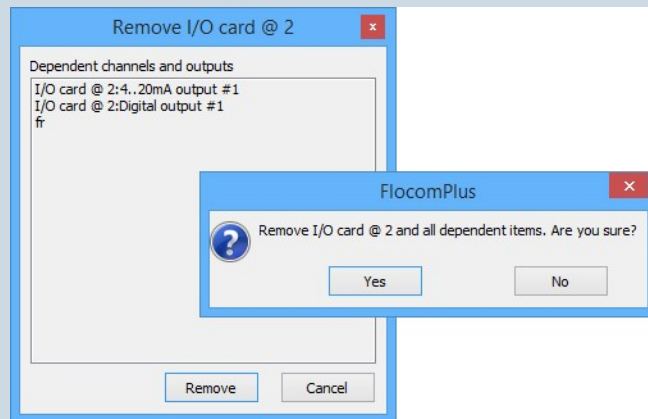

4. Send the "*Device configuration*" and update the unit.

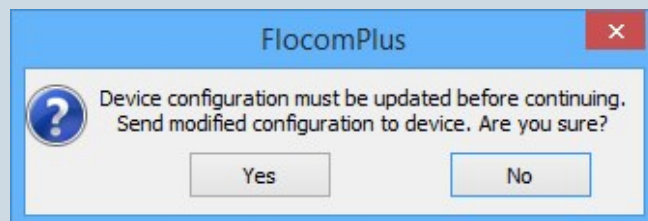

WARNING:



MDCF files can **ONLY** be loaded into XCi devices of the same type. For example, a file from a FloPro XCi **CANNOT** be loaded into an AgriFlo XCi and *vice versa*. A warning will be displayed

Measure and display

The "*Measure and Display*" function provides a quick utility to check that all connected and configured sensors and calculated channels are reporting "expected values". These are the data as they would be logged by the XCi device.



NOTE: This utility should be run every time a unit is configured or re-configured to ensure that the XCi device is correctly setup for the monitoring application.



NOTE: Total channels are not updated in the *"Measure and Display"* mode.

Click *"Measure and display"* then *"Start"* to observe the current channel values. Click *"Stop"* then *"Close"* to return to the main menu.

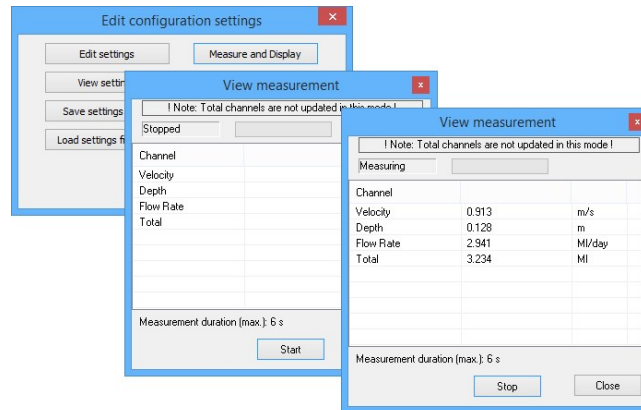

NOTE: See ["Measure and Display" function](#) for further details

Doppler sensor check



NOTE: See ["Doppler sensor check"](#) and [interpreting real-time data](#) for full details

SDI-12 Master utility

When enabled, provides the ability to control SDI-12 sensors prior to deployment. For full details see The ["SDI-12 Master Utility"](#)

WebComm utility

When enabled, provides a utility to communicate directly with the WebComm card prior to deployment. For full details see [The "WebComm Utility"](#)

Start/Stop HVFlo XCi device

Once the HVFlo XCi device has been configured and tested it is ready to be started so that measuring and logging is initiated.



WARNING: If the device is NOT started measurements will NOT occur

From the main menu click “**Start device**” and you will be asked “**Are you sure?**”. Click “**Yes**” and the device will start and you will be returned to the main menu. You will notice that the “**Start Device**” has changed to “**Stop device**” in the main menu.

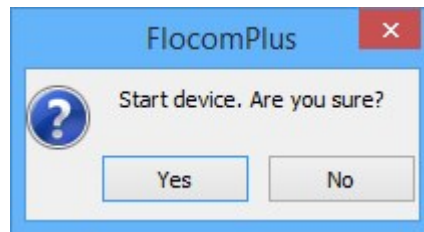

NOTE: To enable changing of settings, access of real-time data and resetting totals, the HVFlo XCi device must first be stopped.

From the main menu click “**Stop device**” and you will be asked “**Are you sure?**”. Click “**Yes**” and the XCi device will stop and you will be returned to the main menu. You will notice that the “**Stop Device**” has changed to “**Start device**” in the main menu.

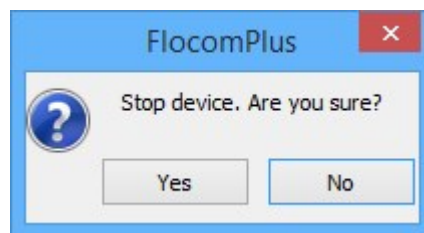

The System menu

From the FloCom+ Main Menu, click "**System**" and the following menu options will appear as listed below:



Set device date/time:

The device date and time must be set correctly, so that data can be accurately matched to known time intervals.

- The date and time can be set by manual entry or by synchronizing with the computer time.
- The time is held in 24 hour time.
- Allowance can be made for daylight savings time.



NOTE: MACE recommends that the user does not use daylight savings time. Users should set to standard time zone at all times.

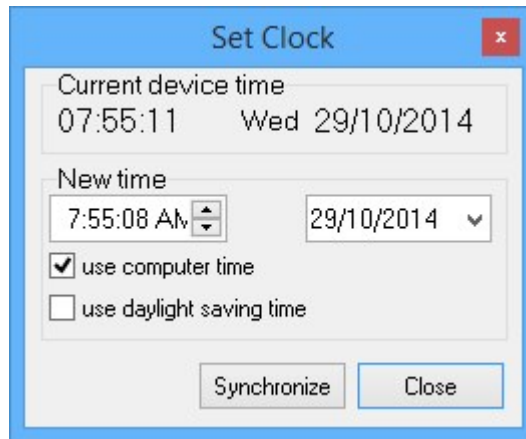

NOTE: MACE recommends that if the user has a WebComm card installed and the device time is needed to be set to an *earlier time*, "[Test an FTP Upload](#)" should be carried out before the time is reset.

Change download password

The download password allows low level access to the device. When this password is used for entry to the device, channel totals may be viewed and data can be downloaded.

Many irrigation districts give this password to irrigators to allow them to use the data for water management operations.



Change super password

The super password allows high level access to the device. When this password is used for entry to the device, all editing functions (including data downloading) are allowed.

Most irrigation districts set this password to prevent non authorized access to the device.



NOTE: Both the super and download passwords are case sensitive.

System settings

The system settings function allows the user to change the measurement units from metric to U.S and vice versa.



NOTE: For US units: "Depth" can be measured in "ft or in". Velocity is always measured in "ft/s".

For Metric units: "Depth" is always measured in "metres", and "Velocity" in "m/s".



NOTE: If the units system is changed the configuration will be reset to defaults

Clear stored data

This function should only be used by high level users. It clears all stored data from the device including all time stamped flow rate data.

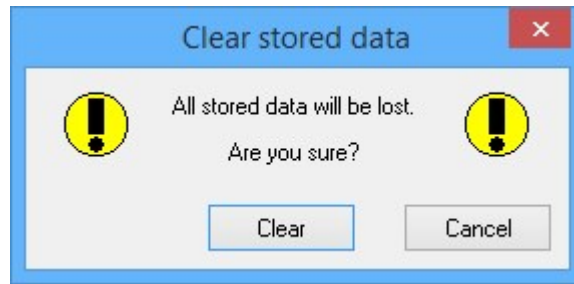

Card check

This function provides the user with a simple method of identifying the FloSeries3 cards that are currently installed in the device. It also includes the various card firmware versions and serial numbers. This information is important as functionality may be changed with later firmware releases.

A dialog box titled "Card check" with a red close button in the top right corner. It contains a table with four columns: Slot, Hardware type, Firmware version, and S/N. The table has five rows of data. Below the table are three buttons: "To Clipboard", "Refresh", and "Exit".

Slot	Hardware type	Firmware version	S/N
1	Doppler card	2.00.08	000014B25FAE
2	I/O card	1.02.04	000013D20E3D
3	SDI-12 Master card	1.01.07	00001408FC7A
5	WebComm SM card	1.02.20	000016BF22F3
	Display card	1.01.04	00000EEDAC0A

View totals

From the main menu click “**View totals**” and the “**Flow volume totals**” dialogue box will appear. This dialogue box lists all the accumulated flow channels and their respective totals and units.

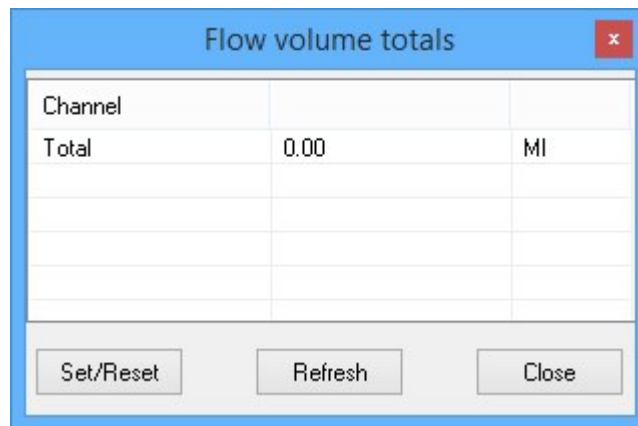

If the HVFlo XCi device has not been started, the “**Set/Reset**” button will be active and the totalised reading can be changed.



NOTE: Only total channels that have been configured as Resettable can have their value reset



WARNING: It is strongly advised to download the logged data **PRIOR** to resetting the total value

1. Highlight the channel you wish to reset by clicking on it's name.
2. Click “**Set/Reset**” and the “**Set total value**” dialogue box will appear.

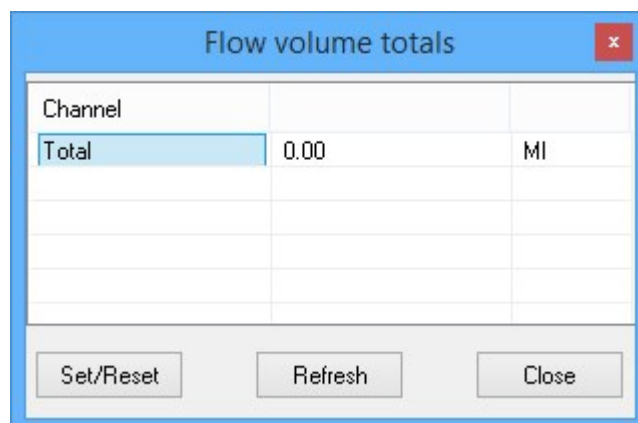

3. Enter the **"New value"** into the field and click **"Set value"**. The new value will then be displayed in the **"Flow volume totals"** dialogue box.

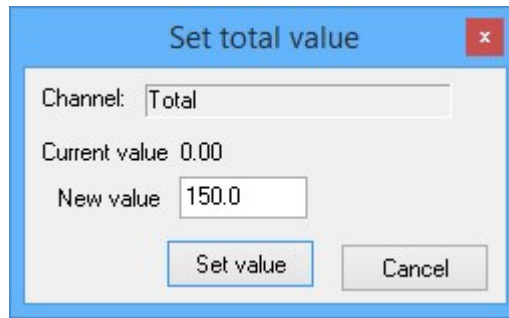

Set total value

Channel: Total

Current value 0.00

New value 150.0

Set value Cancel



WARNING: Double check that this value is CORRECT

4. If the HVFlo XCi device has not been stopped, the **"Set/Reset"** button will be greyed out and the total/s will not be re-settable.
5. To update the reading whilst flow is accumulating, click **"Refresh"**.

Introduction to XCi channel types

The MACE XCi system uses "**Channels**" to enable various measurements to be made and other parameters to be calculated (see [FloCom+ - The essential steps to configuring an HVFlo XCi device](#)). These "**Channel types**" can be defined as:

Connected sensor channels -

These channels output their value based on information received from physically connected sensors wired to the various MACE FloSeries3 Cards.

Calculated channels -

These channels use the values received from "**Connected sensor channels**" and apply algorithms in order to output calculated values. For example, when calculating a flow rate in a partially full pipe a "**Flow rate (using velocity)**" channel type uses the values received from a connected velocity sensor and a connected depth sensor

System channels -

These channels have values directly received from the XCi system.

Full list of XCi channel types and brief description:

XCi Channel Types	Description
Velocity	This channel type MUST be used whenever the resultant velocity measurement will be used in a flow rate calculation. It MUST be used whenever a MACE Doppler ultrasonic sensor is used to measure velocity.
Depth	This channel type MUST be used whenever the resultant depth measurement will be used in a flow rate calculation. It MUST be used whenever a MACE Doppler ultrasonic sensor is used to measure depth.
Doppler stream index	Provides a measure of the signal strength received by a MACE Doppler velocity sensor in calculating the average stream velocity.
Velocity (depth corrected)	Used to apply a correction factor to measured velocity data based upon different depth regimes of the stream.
Flowrate (using velocity)	Used to calculate a flow rate based upon the results obtained from configured velocity and depth channels.

XCI Channel Types	Description
Flowrate (using trickle flow)	This channel uses the Mannings formula to calculate flow rate in a circular pipe based upon depth measurement.
Flowrate (using weir)	Used to calculate a flow rate based upon a depth channel and a selected weir type.
Net flowrate	Used to calculate positive or negative flowrate based on the results obtained by addition or subtraction of two or more configured flow rate channels.
Total flow	Used to calculate an accumulated positive or negative total based on the results obtained from a configured flow rate channel.
Net flow total	Used to calculate an accumulated positive or negative total based on the results obtained by addition or subtraction of two or more configured flow rate channels.
Volume (using lookup table)	Used to calculate the volume of a storage (dam/tank) based upon a depth measurement and a user configured lookup table of the storage geometry.
Device battery voltage	Used to monitor the XCI device internal battery voltage.
Device external voltage	Used to monitor the XCI device external voltage from a solar panel or mains charger.

Add a "Velocity" - channel type

This channel type MUST be used whenever a MACE Doppler ultrasonic sensor is used to measure velocity. This channel type MUST be used whenever the resultant velocity measurement will be used in a flow rate calculation.

Other 3rd party velocity sensors can also be interfaced to the XCi device. These sensors must be one of: [4-20mA](#), Frequency Voltage, or SDI-12 input type. Refer to their respective input "**Channel type**" topics.

1. When adding a "**Velocity**" channel type configured for a MACE Doppler velocity sensor, after selecting the appropriate Doppler card from the "**New Channel - Select card**" dialogue a "**Doppler sensor options**" dialogue box will appear.
2. Select the appropriate "**Sensor type**" from the drop-down list:

Sensor Type:

- MACE Doppler ultrasonic insert velocity sensor - "**2" insert head**"
- MACE Doppler ultrasonic ZXSnapStrap mounted velocity only sensor - "**Strap Mount**"
- MACE Doppler ultrasonic ZXSnapStrap mounted area/velocity (A/V) sensor - "**Strap mount with depth**"

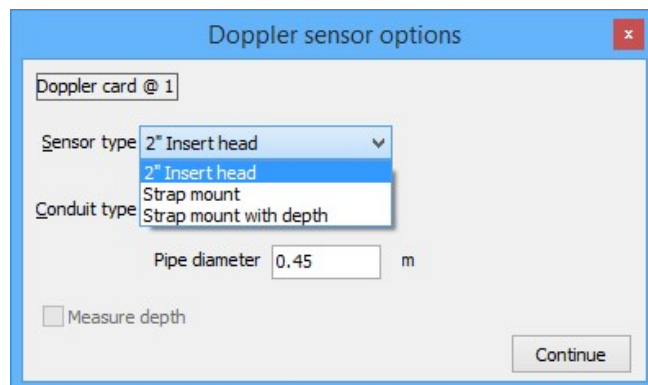

3. Select the appropriate "**Conduit type**" from the drop down list:

Conduit Type:

- "**Circular pipe**" - May be full or partially-full
- "**Non-circular full pipe**" - A full pipe with a known cross-sectional area, such as a box culvert or oval pipe
- "**Other conduit type**" - Non-circular open channel such as a trapezoidal or irregular earthen channel

4. Enter the "**Pipe diameter**" or "**Cross-sectional area**" if applicable.



WARNING: Ensure the diameter or cross-sectional area of the pipe is entered in the appropriate units of measure.

5. If a "**Strap mount with depth**" sensor type was selected and you wish to measure depth with this sensor, click the "**Measure depth**" check box.



WARNING:

Doppler card @ 1

Sensor type: Strap mount with depth

Conduit type: circular pipe

Pipe diameter: 1.5 ft

Diameter/depth units: ft in

Measure depth

Continue

If using US units, ensure that you have selected the appropriate depth units for your application (either ft or inches) at this step as this will globally effect your depth units in the XCi device

Add a "Velocity" - channel type

This channel type MUST be used whenever a MACE Doppler ultrasonic sensor is used to measure velocity. This channel type MUST be used whenever the resultant velocity measurement will be used in a flow rate calculation.

Other 3rd party velocity sensors can also be interfaced to the XCi device. These sensors must be one of: [4-20mA](#), Frequency Voltage, or SDI-12 input type. Refer to their respective input "**Channel type**" topics.

1. When adding a "**Velocity**" channel type configured for a MACE Doppler velocity sensor, after selecting the appropriate Doppler card from the "**New Channel - Select card**" dialogue a "**Doppler sensor options**" dialogue box will appear.
2. Select the appropriate "**Sensor type**" from the drop-down list:

Sensor Type:

- MACE Doppler ultrasonic insert velocity sensor - "**2" insert head**"
- MACE Doppler ultrasonic ZXSnapStrap mounted velocity only sensor - "**Strap Mount**"
- MACE Doppler ultrasonic ZXSnapStrap mounted area/velocity (A/V) sensor - "**Strap mount with depth**"

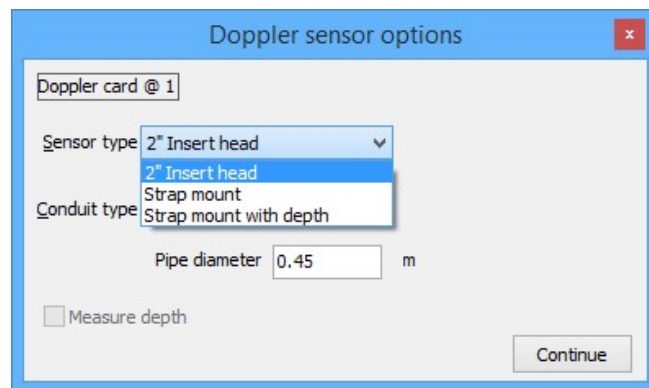

3. Select the appropriate "**Conduit type**" from the drop down list:

Conduit Type:

- "**Circular pipe**" - May be full or partially-full
- "**Non-circular full pipe**" - A full pipe with a known cross-sectional area, such as a box culvert or oval pipe
- "**Other conduit type**" - Non-circular open channel such as a trapezoidal or irregular earthen channel

4. Enter the "**Pipe diameter**" or "**Cross-sectional area**" if applicable.



WARNING: Ensure the diameter or cross-sectional area of the pipe is entered in the appropriate units of measure.

5. If a "**Strap mount with depth**" sensor type was selected and you wish to measure depth with this sensor, click the "**Measure depth**" check box.



WARNING:

Doppler card @ 1

Sensor type: Strap mount with depth

Conduit type: circular pipe

Pipe diameter: 1.5 ft

Diameter/depth units: ft in

Measure depth

Continue

If using US units, ensure that you have selected the appropriate depth units for your application (either ft or inches) at this step as this will globally effect your depth units in the XCi device

Edit a "Velocity" - channel type

After clicking "Edit" from the "Configure channels" dialogue box, the following "Edit channel" dialog will appear if the velocity channel is configured for a MACE Doppler ultrasonic velocity sensor.

 **WARNING: ALWAYS "Apply" the settings after making changes.**

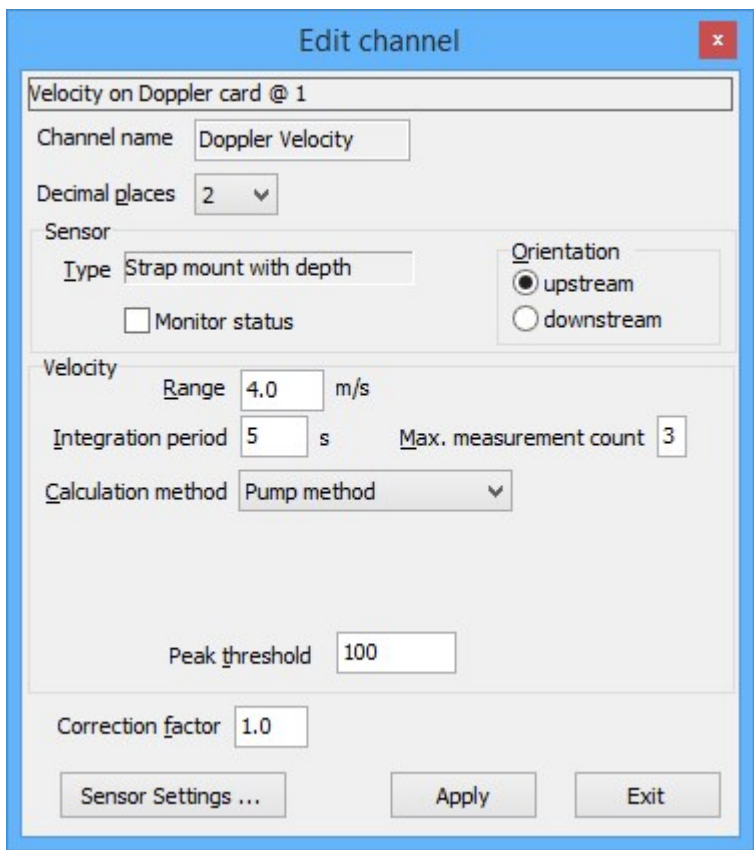

Sensor type

This is the Doppler velocity sensor type selected during the "[Doppler sensor options](#)" procedure.

Monitor status

If this check box is ticked the XCi device will monitor whether or not the sensor is correctly connected to the Doppler card.

Sensor orientation

Under usual field conditions the velocity sensor should be positioned so that the transmitted beam is faced upstream. For example, MACE recommends that the velocity sensor is positioned so that there are 6 pipe diameters of straight flow before the sensor and 2 pipe diameters of straight flow behind the sensor (see [Selecting a suitable site for Doppler ultrasonic velocity measurement](#)). In practice this may not always be possible. However, these conditions may also be met by positioning the sensor to face downstream for 6 pipe

diameters. At poor signal sites, turning the sensor around may help to increase signal strengths.

The “**Orientation**” feature allows the user to tell the processing electronics that although the velocities received are negative (when the sensor is facing downstream), you wish to totalise this flow as positive flow.



NOTE: When receiving data from a sensor facing downstream, the real-time velocity graph will show a spectrum that appears upside down

Velocity range

This parameter sets the range of expected velocities that are to be analysed. MACE Doppler ultrasonic sensors “pigeon-hole” velocity readings into 128 positions over the velocity range set by the user. For example, each “hole” in a range of 0 - 4 m/s is .03125 m/s wide, whereas in a 0 - 1 m/s range each hole is .0078 m/s wide. For example, in a stream in which the user knows that the peak velocity will never exceed say, 0.6 m/s a velocity range of 1 m/s may be set. In this way, the resolution of the final average velocity is increased. In slow moving streams or ones that contain few acoustically reflective particles, a smaller velocity range will often result in far more repeatable data because the instrument does not waste processing power gathering data outside of expected ranges. To be safe, the velocity range should be set larger than expected and the site monitored for several weeks under different flow conditions to determine the peak expected velocity. After this period, the user may find it prudent to increase the resolution by changing the velocity range. MACE Doppler velocity sensors calculate an average velocity by measuring the speed of particles moving through the whole stream cross-section.

In the real-time graph below, the peak velocity (6ft/s) is typically the centre of the pipe whilst the minimum velocity (0-1ft/s) is typically found along the edges.

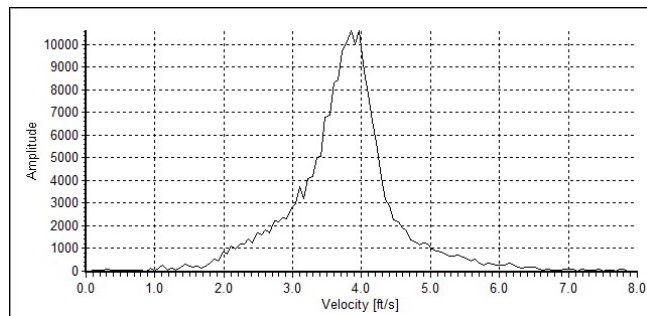

WARNING: The velocity range must be set so that ALL components of the stream velocity are captured when viewed on the “real-time” graph. Failure to do so will compromise the validity of the velocity calculation.



NOTE: As a general rule, the velocity range should be set to double the average velocity of the stream.

Integration period

The integration period is the time period in which samples of the velocity spectrum are taken before an average velocity reading is calculated. The minimum integration time is 4 sec and the maximum integration time is 180 seconds and may be reduced automatically by the measurement interval and the maximum measurement count depending upon the instrument configuration.

The integration time may be varied for several reasons:

- Under field conditions where the flow is fluctuating dramatically, increasing the integration time will help to get a more accurate average velocity reading, because more samples are available to calculate the average .
- Under field conditions where the flow has a low number of acoustically reflective particles, increasing the integration time will help to get a more accurate average velocity reading, because more reflective targets will be sampled to calculate the average.



NOTE: The power consumption of the system is affected by the integration time. The longer the unit is on and physically sampling, the shorter the battery life without charging. The XCi device internal battery has a 7.2 Ah capacity. During an integration period each Doppler sensor will draw approximately 80 mA.

Maximum measurement count

Under certain flow or no flow conditions signal noise may disrupt the calculation of a true average velocity reading. As described the peak threshold feature is designed to overcome this problem. However, unwanted velocity readings may be derived from other sources such as aquatic life, which may give strong signal strengths.

Within all MACE Doppler ultrasonic instruments one of two flow states can occur. The stream can either be moving or stationary. For example, a sensor submerged in a river diversion pipe that is used to pump irrigation water may be full at times when no water is being pumped. Under these conditions, it is common for fish and aquatic invertebrates to inhabit the pipeline. Unfortunately, to a Doppler ultrasonic velocity sensor, a fish swimming at 500 mm/s is computed as a full pipe of water moving at 500 mm/s. This type of erroneous flow reading will result in an increase in the totalised flow. Conversely, in a slow moving stream or one that contains few acoustically reflective particles, a velocity reading may be missed if there is insufficient data to analyse. Under this circumstance, the totaliser will not be incremented.

To overcome this problem, MACE XCi devices include the maximum measurement count feature whereby if the instrument detects a state change (i.e flow has started or flow has stopped) it stays on and takes X number of readings to confirm this situation. If all X number of readings meet the criteria for a valid reading as set by, peak threshold, flow threshold, minimum stream activity and stream activity percentage, then the reading is accepted and the change of state confirmed. If the readings do not all agree that there has been a change of state, then the reading is “discarded” and the current flow state remains. That is, the unit continues to calculate zero flow or accepts the flow rate as calculated. Furthermore, the instrument also checks that the direction of flow has not changed within the X readings. For example, if there is zero flow and the unit detects a reading of positive flow and another of negative flow then the overall reading is discarded and the unit continues to register a zero flow.

The number of readings used for the maximum measurement count is configurable by the user.

Calculation method

“Pump method”

Under normal conditions, water flow that is provided by a pump is turbulent and contains a vast number of acoustically reflective particles, particularly miniature air bubbles that are a result of cavitation events. In monitoring sites that are pumped, or where low signal strengths are uncommon, the pump method should be used.

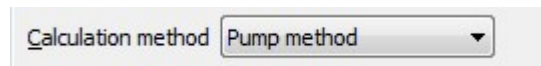

"Surface wave rejection"

In severely turbulent, open conduit flows such as encountered in a sewerage system, it is common for standing waves to develop in the flow stream. If situated closely, these standing waves (surface waves) may confound a Doppler ultrasonic sensor because they typically result in reflections of a significantly slower velocity. In the diagram, a surface wave can be seen as a sharp peak on the real-time graph at about the 0.2 m/s mark.

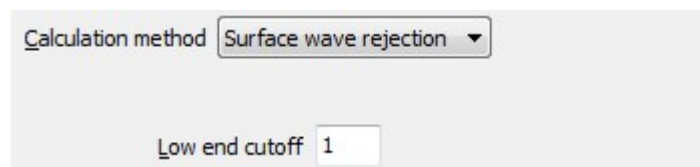

In this case, if the user selects the surface wave rejection calculation method a menu item called “low-end cutoff” will be displayed. This feature enables the user to force the instrument to ignore Doppler shifts that lie between zero and the low-end cutoff. The low-end cutoff is a percentage of the range (x-axis) of the real-time graph. In the diagram the low-end cutoff would be configured to about 10% of the graph. That is, any data that are received between 0 and 0.4m/s will be ignored when computing an average stream velocity

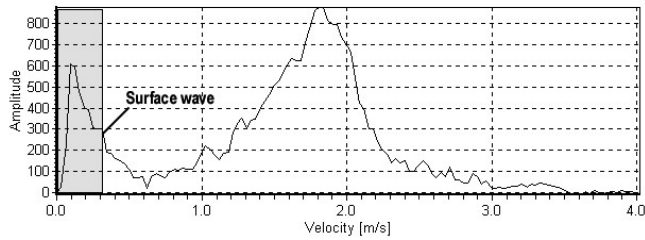

NOTE: Greyed area, not represented in actual real-time graph

“Gravity method”

This method should be used wherever a stream is slow moving and/or contains few acoustically reflective particles. Because this calculation method is designed to enhance the velocity processing of slow

moving/clean streams, it may also result in erroneous velocity readings unless enabled correctly. When enabled, this method will display two new menu items.

- **“Minimum stream activity”** - Under conditions of zero flow within a conduit (see maximum measurement count) a single aquatic life form can produce large Doppler shifts. The minimum stream activity parameter must be set to negate the effects of these aquatic life forms. This parameter should be set to low values (2-10) in sites where extremely slow average velocities are expected (< 0.2 m/s). Values greater than 10 can be set where average velocities of >0.2 m/s are expected.
- **“Stream activity percentage”** - To be used in conjunction with the minimum stream activity parameter, this parameter forces the instrument to utilise only those velocity spectra that have a minimum stream activity value greater than set by the user. Under good acoustic conditions typically 90 –100% of the data received by the velocity sensor will be used to calculate an average velocity. Under conditions where the data received by the velocity sensor has been caused by aquatic life, typically <10% of the data will be used. Therefore, this parameter should be set to low values (2-10) in sites where extremely slow average velocities are expected (< 0.2 m/s). Values greater than 10 can be set where average velocities of >0.2 m/s are expected.



WARNING: The user **MUST** check that the value entered for both “Minimum stream activity” and “Stream activity percentage” do not cause real velocity data to be ignored

- **“Wind effect filter”** - Under certain field conditions, a stream may move in a positive direction but the prevailing winds may come from the opposite (negative) direction. The effect of this on Doppler ultrasonic processing is that a strong negative Doppler shift may be “seen” as well as the actual positive shift of the stream itself. In some cases the shift caused by the winds may overwhelm the shift from the slower moving water flow and cause erroneous flow rate readings. The “Wind effect filter” is built in to allow the user to overcome such sources of error.
 - **“Disabled”** - When checked, all filtering is off.
 - **“Positive ”** - When checked, all negative velocity components are filtered out.
 - **“Negative ”** - When checked, all positive velocity components are filtered out.



WARNING: The user **MUST** check that the “Wind effect filter” does not cause real velocity data to be ignored

Velocity peak threshold

Doppler shifts that are unrelated to the measurement of velocities in a stream are often called “signal noise”.

This “noise” can be a result of several different factors including:

- Electromagnetic interference;
- Reflections of signals from other echoes.

In some situations background noise may interfere with the calculation of correct average velocity readings.

MACE XCi instruments feature a “noise filter” called a **“Peak threshold”**.

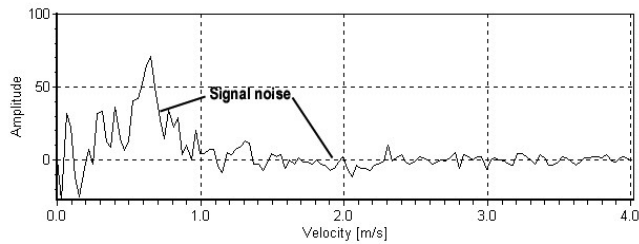

In the figure above signal noise can be seen on the velocity spectrum graph as low signal strength echoes. In the graph above you can see that the signal noise has an approximate amplitude value of 75. Therefore, by setting a threshold of say 100, this noise will be ignored in the computation of average velocity. The user should be careful however, at sites where signal strength is inherently lower, a peak threshold that is set too high could mean that true velocity readings are discarded.

This feature is particularly useful at sites where the sensor may be submerged for periods where no flow is occurring. For example, signal noise encountered in a submerged 1 m diameter pipeline that gives a false “average velocity” of 1 m/s will still increase a totalising counter by 785 litres per second, even though no true flow existed. By watching several real-time graphs of no flow conditions and monitoring the extent of signal noise apparent, a peak threshold may be set so that signal noise is not computed as real flow.

Correction factor

Unfortunately, ideal hydraulic conditions cannot be achieved at every site that requires monitoring. In locations where hydraulic conditions are such that velocity calibrations at various flow regimes are required, then the “**Correction factor**” may help. Under abnormal hydraulic conditions, the average velocity of the stream must be calculated using traditional means that comply with Australian (refer to AS3778 series) or International Standards (refer to ISO772).



WARNING: The velocity correction factor can be set to scale the calculated velocity result and should only be used with extreme care

It allows a single multiplication factor to be applied to the calculated velocity readings.

For example, should a **trusted** primary source of flow measurement show that the XCi device is under-reading by 5%, then the correction factor should be set to 1.05. If it is proven to be over-reading by 5% then the correction factor should be set to 0.95.

"Sensor settings"

Clicking on "**Sensor settings**" will open up the "**Doppler sensor options**" dialogue box. The only available function is the ability to change the "**Pipe diameter**" or "**Cross-sectional area**". All other settings are "greyed out".



NOTE: To change the "Sensor type" or "Conduit type", the complete "Velocity" channel must be removed ()

Recommended "Velocity" settings for typical Doppler ultrasonic applications

The following settings are recommended as a starting point for configuration of the Doppler sensor/card for typical applications.



NOTE: The user should ALWAYS ensure that the configuration is correct for their specific application.

"Velocity" Channel Type Parameter	Doppler Ultrasonic Sensor Applications					
	Pumped irrigation ¹ (Full pipe)	Pumped Wastewater (Full pipe)	Gravity-fed irrigation (Full pipe)	Gravity-fed Irrigation (Partially full pipe)	Gravity-fed Wastewater (Partially full pipe)	Gravity-fed Irrigation (open channel)
Orientation	Upstream	Upstream	Upstream	Upstream	Upstream	Upstream
Velocity Range ¹	Double the Average Velocity	Double the Average Velocity	Double the Average Velocity	Double the Average Velocity	Double the Average Velocity	Double the Average Velocity
Integration Period	10 seconds	5 seconds	20 seconds	20 seconds	10 seconds	30 seconds
Calculation Method ²	Pump Method	Pump Method	Gravity Method	Gravity Method	Gravity Method	Gravity Method
Max. Measurement Count	1	1	3	3	1	3
Minimum Stream Activity ³	n/a	n/a	4	4	0	4
Stream Activity Percentage ³	n/a	n/a	5	5	0	5

1. The velocity range must be set so that ALL components of the stream velocity are captured when viewed on the "real-time" graph. Failure to do so will compromise the validity of the velocity calculation. As a general rule, the velocity range should be set to double the average velocity of the stream. To determine the average velocity the user MUST perform a "Doppler Sensor Check".

2. "Pump method" should be used whenever a MACE Doppler ultrasonic velocity sensor is installed in either the suction or discharge pipe of a pump. Once the fluid is free flowing then the "Gravity method" should be used. For example, If a pump discharges into an open channel the "Pump method" should be used in the discharge line of the pump, whilst the "Gravity method" should be used in the open channel.

3. The user MUST check that the value entered for both "Minimum stream activity" and "Stream activity percentage" do not cause real velocity data to be ignored.

"Doppler stream index"- channel type

The Doppler stream index provides a simple measure of the number of acoustically reflective particles and their relative signal strengths. This index is generated for each velocity calculation. As a general rule of thumb an index value of 10 or greater is a requisite for repeatable velocity readings.



WARNING: If an index value of less than 10 is consistently observed the site may not be suitable for Doppler ultrasonic velocity measurement

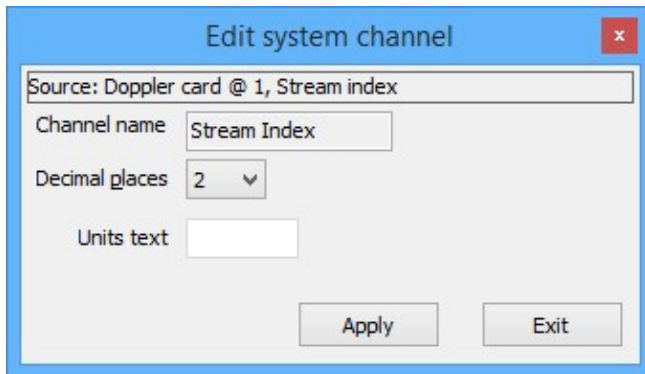

Source: Doppler card @ 1, Stream index

Channel name: Stream Index

Decimal places: 2

Units text:

Apply Exit



NOTE: There are no editable parameters for this channel type.

"Depth" - channel type

This channel type MUST be used whenever the resultant depth measurement will be used in a flow rate calculation. It MUST be used whenever a MACE Doppler ultrasonic sensor is used to measure depth.

So, what are "Slope" and "Offset"?

Most environmental sensors have a linear relationship between the measuring range and the electrical output range of the sensor.

For a depth sensor this relationship can easily be described using the well known equation of a straight line $Y = mX + B$

Where:

- **Y** = Depth
- **m** = Slope
- **X** = Sensor output
- **B** = Offset

Or in other words:

$$\text{Depth} = \text{Slope} \times (\text{Sensor output}) + \text{Offset}$$

Where:

- **Depth** = measured value
- **Slope** = Sensor measuring range / Span (difference between the sensor output at the top of the measured range and the sensor output at zero)
- **x** = Sensor raw value output
- **Offset** = - (Slope X Sensor output at zero)

For example, a typical ceramic depth sensor incorporated into the MACE Area/Velocity sensor, has a sensing range of 4 metres and a frequency output range of approx. 1.5 kHz to 14.5 kHz. Therefore:

- Sensor measuring range = 4 metres
- Sensor span = 14.5 kHz - 1.5 kHz = 13 kHz
- **Slope = 4/13 = 0.30769**
- **Offset = -(0.30769 X 1.5) = - 0.46154**
- The final equation - **Depth = 0.30769X - 0.46154**

Or, for a graphical representation of this equation:

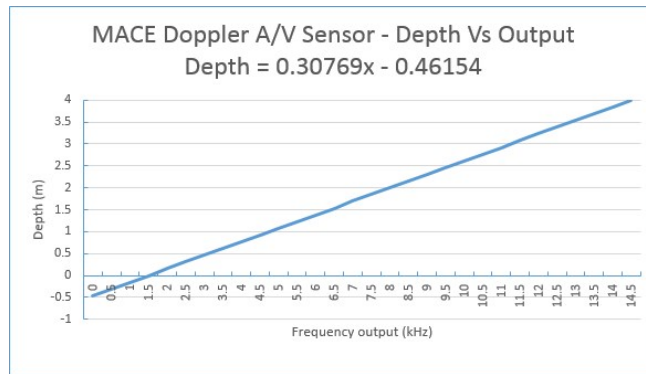

WARNING: Due to natural variability of the ceramic depth sensing diaphragm and associated electronics, these numbers are approximations and should not be used in configuring an XCi device. They are provided for illustrative purposes ONLY

"Depth" channel from a MACE Doppler Sensor



NOTE: This "Depth" channel will ONLY be enabled if the "Measure depth" check box was ticked in the setup during "Doppler sensor options" procedure see [Sensor Type](#):

The MACE ceramic depth sensor that is incorporated into the MACE Area/Velocity (A/V) sensor has a frequency output proportional to depth. This sensor is supplied with factory calibration tag indicating the sensor's slope and offset values



NOTE: The factory calibration tag includes slope/offset values for both metres (m) and inches (in). Be sure to enter the correct values for the selected depth units

"Depth" channel from a MACE EchoFlo Depth Sensor

The Slope and Offset values of the installed EchoFlo are dependent on the "Fill Height" as entered during the EchoCal configuration procedure.



NOTE: The following calculations are based on the EchoFlo being configured with a frequency output.

Manually calculating Slope

Slope = Fill Height ÷ Sensor Span

Fill Height: The maximum depth measured by the EchoFlo. Refer to the EchoFlo Quick Start Guide for further details.

Sensor Span: Is the difference between the sensor output at the top of the “**Fill Height**” (2000Hz) and the sensor output at the bottom (976Hz). The frequency output of an EchoFlo has a span of 1024Hz .

Manually calculating Offset

Offset = - (Slope x Sensor output at zero)

Metric example - you wish to calculate the slope and offset for an EchoFlo that has been configured with a “**Fill Height**” of 0.75m (75cm).

The following calculations will provide the sensor’s slope and offset:

Slope

$$= 0.75 \div (2000-976)$$

$$= 0.75 \div 1024$$

$$= 0.00073$$

Offset

$$= - (0.00073 \times 976)$$

$$= - 0.71484$$

US example - you wish to calculate the slope and offset for an EchoFlo that has been configured with a “**Fill Height**” of 30”.

The following calculations will provide the sensor’s slope and offset:

Slope

$$= 30 \div (2000-976)$$

$$= 30 \div 1024$$

$$= 0.02929$$

Offset

$$= - (0.02929 \times 976)$$

$$= - 28.59375$$



NOTE: Be sure to record the relevant values for “*Slope*”, “*Offset*”, and depth units.

Edit a "Depth" - channel type

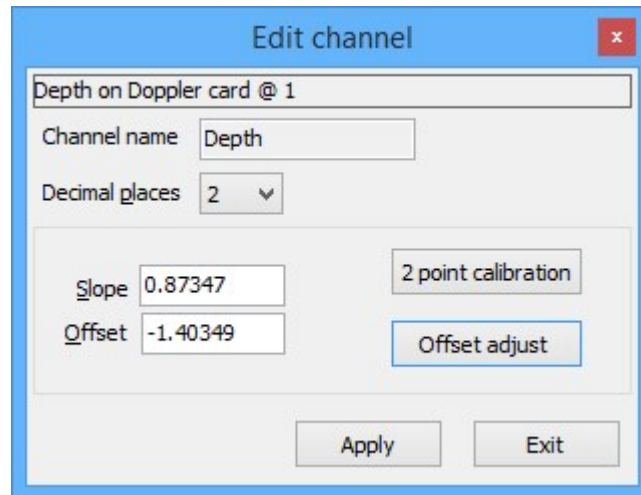

The screenshot shows a dialog box titled "Edit channel" with a red close button in the top right corner. The dialog contains the following fields and buttons:

- Channel name: "Depth" (text input)
- Decimal places: "2" (dropdown menu)
- Slope: "0.87347" (text input)
- Offset: "-1.40349" (text input)
- Buttons: "2 point calibration", "Offset adjust", "Apply", and "Exit".

1. Enter the appropriate "**Slope**" and "**Offset**" values that are either supplied with the depth sensor or have been calculated.
2. Perform either an "**Offset adjust**" or "**2-point calibration**" to ensure accurate measuring results are recorded



NOTE: See either "**Offset adjust**" function or "**2-Point Calibration**" function for full details of these procedures.

3. Click "**Apply**" to save the settings and "**Exit**" to return to the "**Configure channels**" dialogue box.

"Flowrate (using velocity)"- channel type

This channel type is used to calculate a flow rate based upon the results obtained from configured velocity and depth channels.

Add a "Flowrate (using velocity)"- channel type

1. After selecting the ""**Flowrate (using velocity)**" channel type and naming the new channel, the "**Select velocity channel**" dialogue box will appear prompting you to use the drop down list to highlight the "**Velocity channel**" from which the new "**Flowrate (using velocity) channel**" will receive its value.

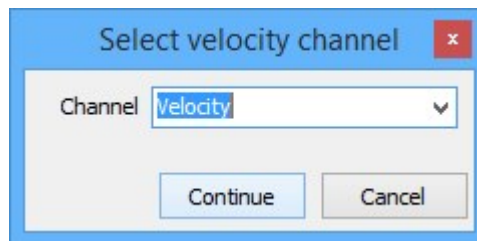

2. Click "**Continue**" and the "**Flowrate measurement type**" dialogue box will appear.

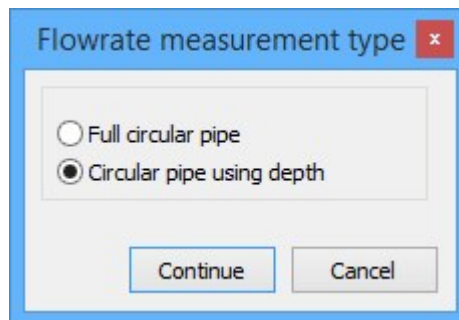

3. Select either "**Full circular pipe**" or "**Circular pipe using depth**" depending upon your application.
4. If you select "**Full circular pipe**", click "**Continue**" to complete the new channel. If you select "**Circular pipe using depth**", click "**Continue**" and the "**Select depth channel**" dialogue box will appear. In the "**Select depth channel**" dialogue box use the drop down list to highlight the "**Depth**" channel from which the "**Flowrate (using velocity)**" channel named will receive its value. Click "**Continue**" to complete the new channel.



NOTE: If “*Other conduit type*” was selected when adding a “*Velocity*” channel, then the “*Flowrate measurement type*” dialogue box will not appear and FloCom+ will automatically prompt for selection of both “*Velocity*” and “*Depth*” channels.

Edit a “Flowrate (using velocity)” - In a full pipe or circular pipe using depth

Flowrate: circular pipe using depth

Channel name: Flow Rate

Decimal places: 2

Velocity channel: Velocity

Depth channel: Depth

Flowrate units: Ml /day

Pipe diameter: 0.45 m

Siltation depth: 0.0 m

Apply Exit

Flowrate units

Select the units and the timebase from the drop down list boxes. This sets the units on the logged value.

Pipe diameter or cross-sectional area

The “*Pipe diameter*” or “*Cross-sectional area*” when configuring a “*Flowrate (using velocity)*” channel is preset when the “*Velocity*” channel is added to the configuration.

Siltation depth

This parameter can be used to correct the calculated flow rate if a known amount of silt is inside the pipe. The depth of silt will be subtracted from the area calculation in order to calculate the corrected flow rate.

Edit a “Flowrate (using velocity)” - In an open channel

When the stream flow is in an open channel (non-circular), the user must determine the cross-sectional area and relate it to depth via a polynomial equation. MACE XCi devices use 5th order polynomial equations.

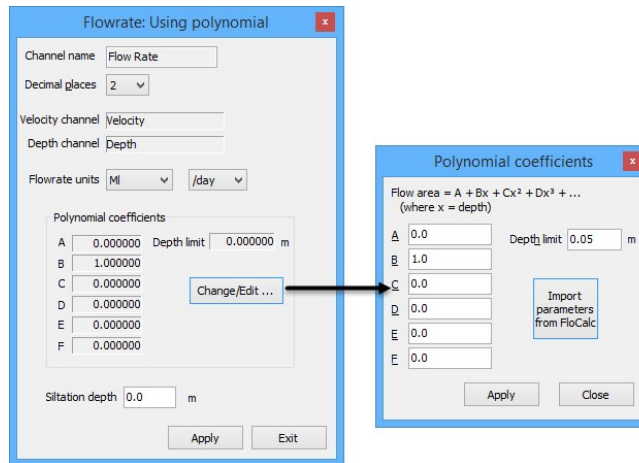

Flowrate units

Select the units and the timebase from the drop down list boxes. This sets the units on the logged value.

Polynomial coefficients

The polynomial coefficients listed in FloCom+ are related to the following equation:

$$\text{Cross-Sectional Area} = A + B \cdot X + C \cdot X^2 + D \cdot X^3 + E \cdot X^4 + F \cdot X^5$$

Where X = depth of stream The coefficients are listed in order A, B, C, D, E, F.

Siltation depth

This parameter can be used to correct the calculated flow rate if a known amount of silt is inside the pipe. The depth of silt will be subtracted from the area calculation in order to calculate the corrected flow rate.

Depth limit

When the cross-sectional area of a stream is calculated using the polynomial coefficient method, the user must set the "**Depth limit**" at which the polynomial reaches a maximum. For example, if a channel has a maximum depth of 1.0m the "**Depth limit**" should be set at 1.0m as well. Alternatively the "**Depth limit**" can be set within *FloCalc* and the procedure described for importing polynomial coefficients.

Import parameters from FloCalc

If the user does not know the coefficients for the polynomial equation, they can be calculated using the MACE utility "*FloCalc*"

Using MACE "*FloCalc*" to calculate polynomial coefficients

The Mace utility program "*FloCalc*" (download separately from www.macemeters.com) can be used to draw regular and irregular channel shapes. These shapes are then converted into a 5th order polynomial. Their coefficients can be imported directly into the appropriate fields in FloCom+

1. Click "**Import parameters from FloCalc**" and MACE FloCalc will open on the "**Profile Designer**" tab sheet.

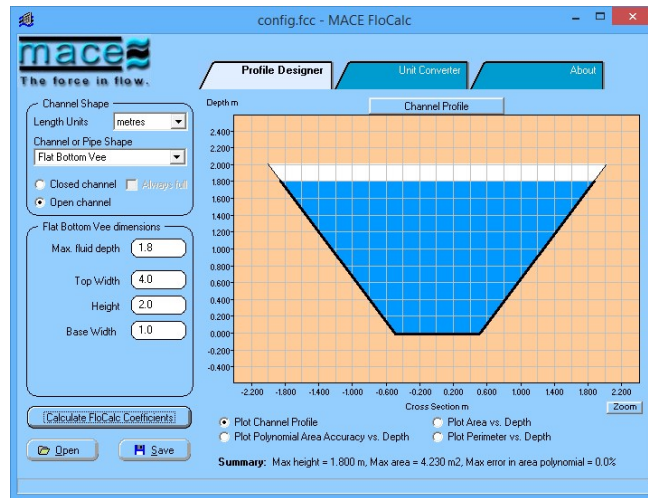

2. Describe/draw your channel or pipe shape using FloCalc (see separate FloCalc Product Manual)
3. Click "**Calculate FloCalc Coefficients**" and the "**MACE FloCalc Coefficients**" dialogue box will appear.

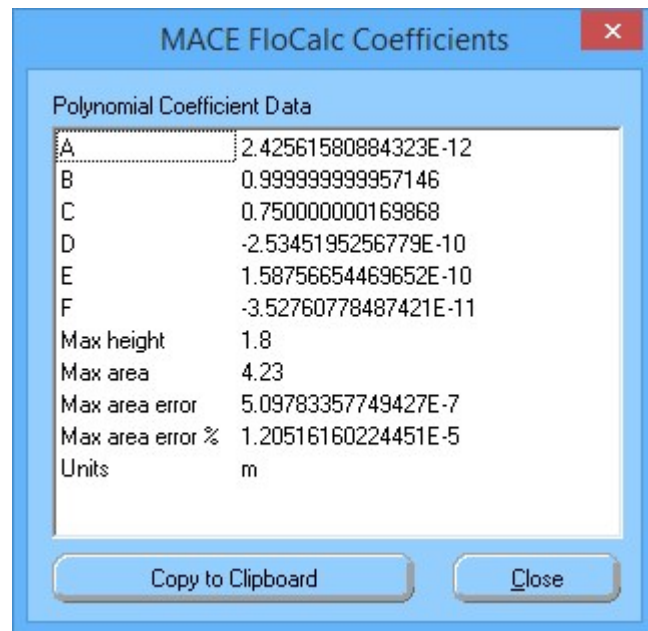

4. Click "**Copy to Clipboard**" then click "**Close**" and exit from FloCalc.
5. The "**FloCalc parameters**" dialogue box will appear containing the calculated polynomial coefficients.
6. Review the coefficients and click "**Apply**" to update the "**Polynomial coefficients**" dialogue box.
7. Click "**Apply**" and the coefficients in the "**Flowrate: Using polynomial**" dialogue box will be set.

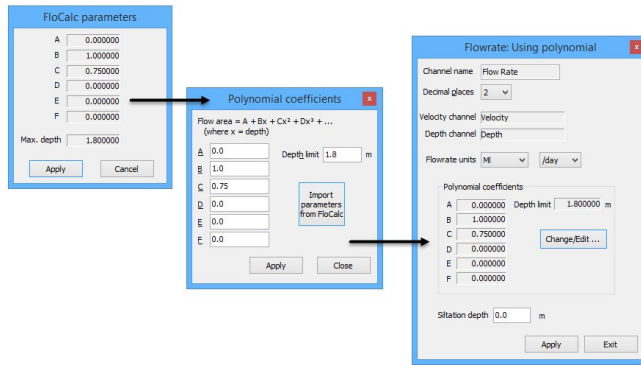

"Flowrate (using velocity)"- channel type

This channel type is used to calculate a flow rate based upon the results obtained from configured velocity and depth channels.

Add a "Flowrate (using velocity)"- channel type

1. After selecting the ""**Flowrate (using velocity)**" channel type and naming the new channel, the "**Select velocity channel**" dialogue box will appear prompting you to use the drop down list to highlight the "**Velocity channel**" from which the new "**Flowrate (using velocity) channel**" will receive its value.

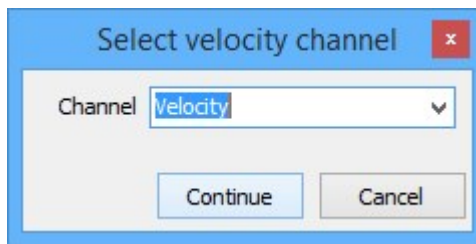

2. Click "**Continue**" and the "**Flowrate measurement type**" dialogue box will appear.

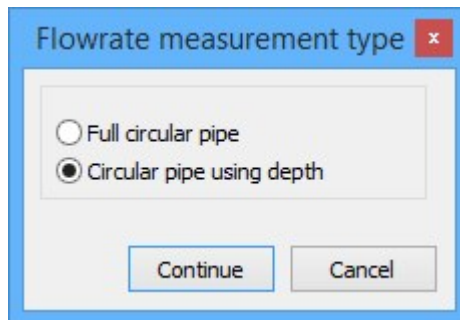

3. Select either "**Full circular pipe**" or "**Circular pipe using depth**" depending upon your application.
4. If you select "**Full circular pipe**", click "**Continue**" to complete the new channel. If you select "**Circular pipe using depth**", click "**Continue**" and the "**Select depth channel**" dialogue box will appear. In the "**Select depth channel**" dialogue box use the drop down list to highlight the "**Depth**" channel from which the "**Flowrate (using velocity)**" channel named will receive its value. Click "**Continue**" to complete the new channel.



NOTE: If "**Other conduit type**" was selected when adding a "**Velocity**" channel, then the "**Flowrate measurement type**" dialogue box will not appear and FloCom+ will automatically prompt for selection of both "**Velocity**" and "**Depth**" channels.

Edit a "Flowrate (using velocity)" - In a full pipe or circular pipe using depth

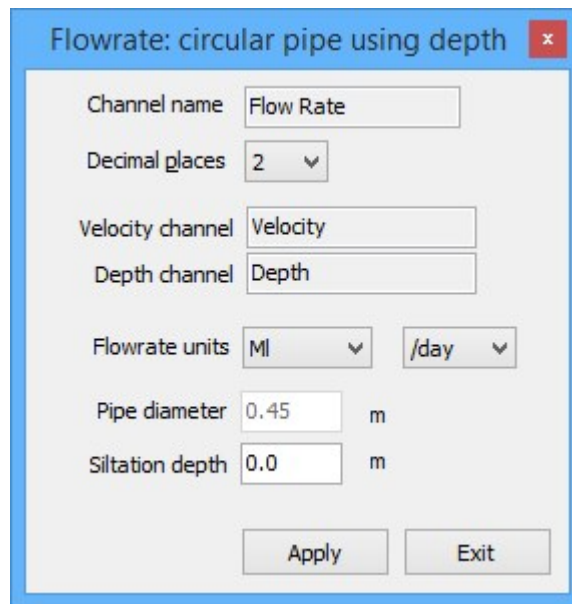

The screenshot shows a configuration dialog box titled "Flowrate: circular pipe using depth". It contains the following fields and controls:

- Channel name: Flow Rate
- Decimal places: 2
- Velocity channel: Velocity
- Depth channel: Depth
- Flowrate units: Ml /day
- Pipe diameter: 0.45 m
- Siltation depth: 0.0 m
- Buttons: Apply, Exit

Flowrate units

Select the units and the timebase from the drop down list boxes. This sets the units on the logged value.

Pipe diameter or cross-sectional area

The "**Pipe diameter**" or "**Cross-sectional area**" when configuring a "**Flowrate (using velocity)**" channel is preset when the "**Velocity**" channel is added to the configuration.

Siltation depth

This parameter can be used to correct the calculated flow rate if a known amount of silt is inside the pipe. The depth of silt will be subtracted from the area calculation in order to calculate the corrected flow rate.

Edit a "Flowrate (using velocity)" - In an open channel

When the stream flow is in an open channel (non-circular), the user must determine the cross-sectional area and relate it to depth via a polynomial equation. MACE XCi devices use 5th order polynomial equations.

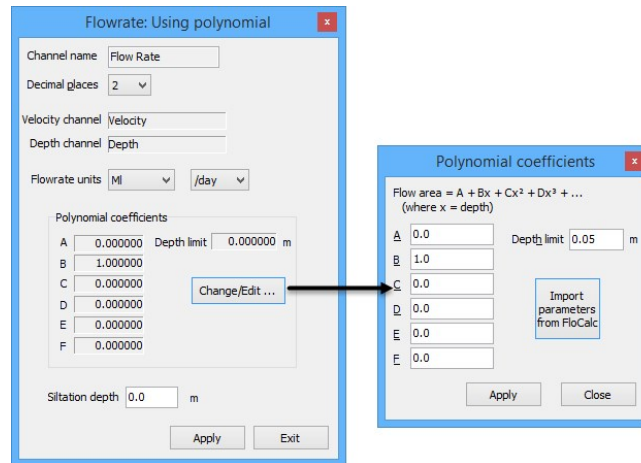

Flowrate units

Select the units and the timebase from the drop down list boxes. This sets the units on the logged value.

Polynomial coefficients

The polynomial coefficients listed in FloCom+ are related to the following equation:

$$\text{Cross-Sectional Area} = A + B \cdot X + C \cdot X^2 + D \cdot X^3 + E \cdot X^4 + F \cdot X^5$$

Where X = depth of stream The coefficients are listed in order A, B, C, D, E, F.

Siltation depth

This parameter can be used to correct the calculated flow rate if a known amount of silt is inside the pipe. The depth of silt will be subtracted from the area calculation in order to calculate the corrected flow rate.

Depth limit

When the cross-sectional area of a stream is calculated using the polynomial coefficient method, the user must set the "**Depth limit**" at which the polynomial reaches a maximum. For example, if a channel has a maximum depth of 1.0m the "**Depth limit**" should be set at 1.0m as well. Alternatively the "**Depth limit**" can be set within *FloCalc* and the procedure described for importing polynomial coefficients.

Import parameters from FloCalc

If the user does not know the coefficients for the polynomial equation, they can be calculated using the MACE utility "*FloCalc*"

Using MACE "FloCalc" to calculate polynomial coefficients

The Mace utility program "*FloCalc*" (download separately from www.macemeters.com) can be used to draw regular and irregular channel shapes. These shapes are then converted into a 5th order polynomial. Their coefficients can be imported directly into the appropriate fields in FloCom+

1. Click "**Import parameters from FloCalc**" and MACE FloCalc will open on the "**Profile Designer**" tab sheet.

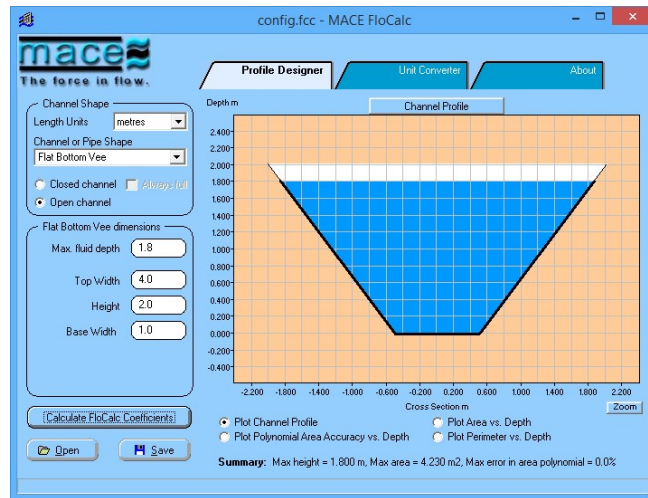

2. Describe/draw your channel or pipe shape using FloCalc (see separate FloCalc Product Manual)
3. Click "**Calculate FloCalc Coefficients**" and the "**MACE FloCalc Coefficients**" dialogue box will appear.

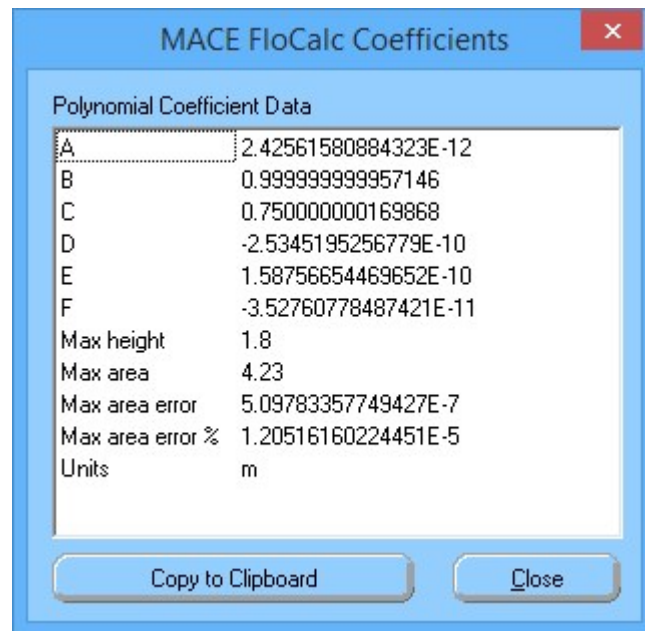

4. Click "**Copy to Clipboard**" then click "**Close**" and exit from FloCalc.
5. The "**FloCalc parameters**" dialogue box will appear containing the calculated polynomial coefficients.
6. Review the coefficients and click "**Apply**" to update the "**Polynomial coefficients**" dialogue box.
7. Click "**Apply**" and the coefficients in the "**Flowrate: Using polynomial**" dialogue box will be set.

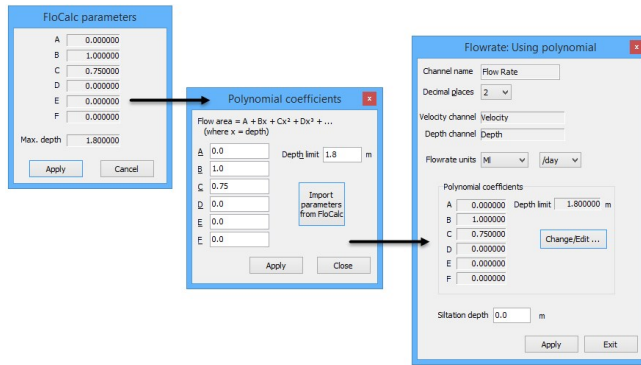

"Flowrate (using lookup table)"- channel type

This channel is used to calculate a flow rate based upon a depth channel and a user configured lookup table of a rated structure.

Add a "Flowrate (using lookup table)" - channel type

1. When adding the "**New channel**" select the related "**Depth**" channel from the drop down list.

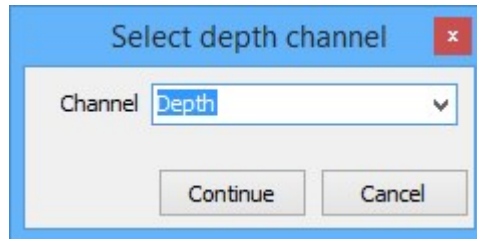

2. Click "**Continue**" and the "**Configure channels**" dialogue box will re-appear with the new channel listed.

Edit a "Flowrate (using lookup table)" - channel type

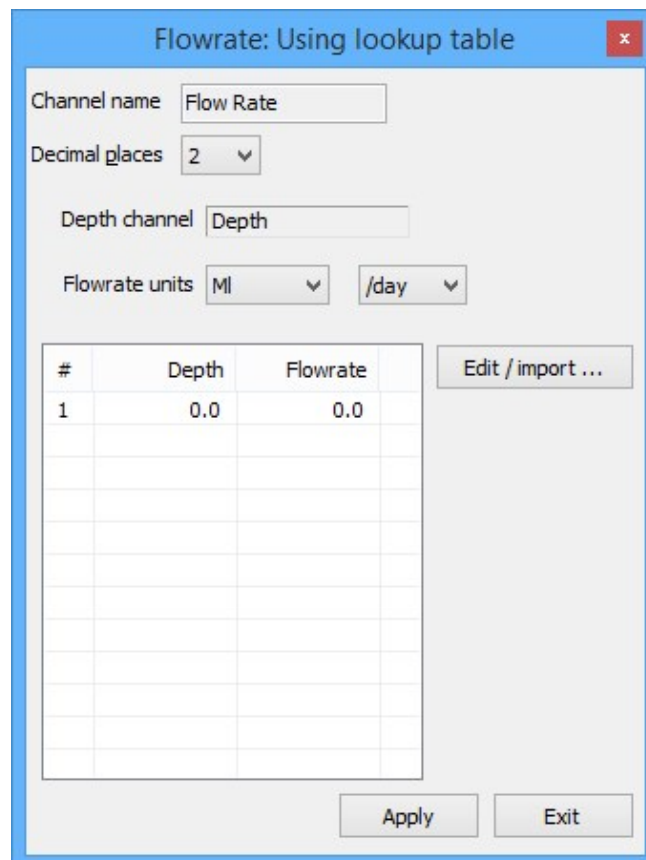

#	Depth	Flowrate
1	0.0	0.0

Flowrate units

Select the units and the timebase from the drop down list boxes. This sets the units on the logged value.

Lookup table values

Lists the flowrates that will be calculated at the corresponding measured depths.



NOTE: The lookup table has a maximum of 35 lines available for use. This maximum is memory dynamic and may be reduced depending upon other channel configurations.

Edit/import

1. From the “**Flowrate: Using lookup table**” dialogue box click “**Edit/import**” and the “**Edit/import LUT data**” dialogue box will appear.
2. Lookup table values can be entered here directly. The depth and corresponding flowrate values must be separated by a comma (,).

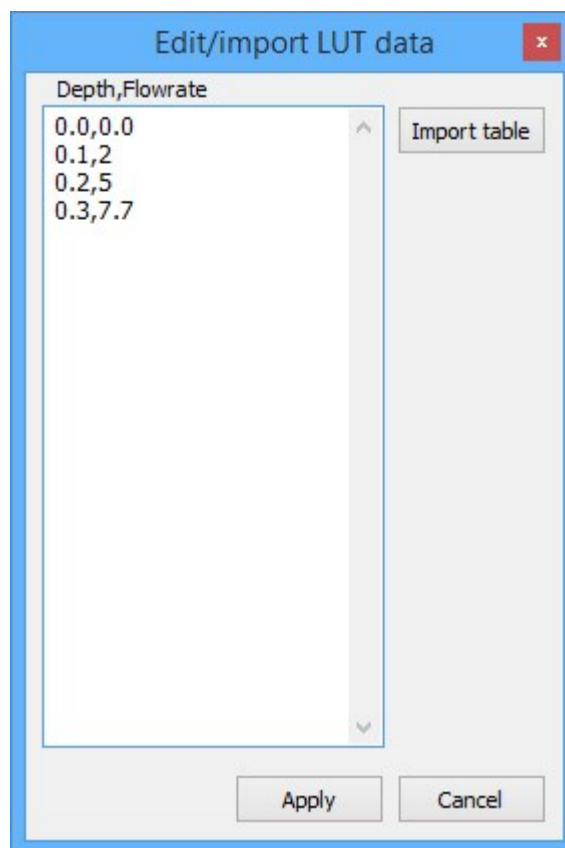

- Alternatively, values may be imported from a *.CSV file. Click **"Import table"** and a Windows® **"Open"** dialogue box will appear prompting the selection of a *.CSV file. Click **"Open"** and the values will be imported.



NOTE: The *.CSV table should be in the format of two columns, one for **"Depth"** and the other **"Flowrate"**. Any text in the data will cause a **"parsing"** error and should be removed for successful import.

- Click **"Apply"** and the **"Flowrate: Using lookup table"** dialogue box will appear containing the updated values.

#	Depth	Flowrate
1	0.0	0.0
2	0.1	2.0
3	0.2	5.0
4	0.3	7.7

"Flowrate (using weir)"- channel type

The HVFlo XCi device contains in-built equations for allowing users to measure flow rate through rated structures such as flumes and weirs. The table below lists the structures supported and the equations used to calculate flow rate. All of the weir equations assume that the flow is fully contracted, meaning that the approach channel is wide enough and deep enough that the proximity of the floor and sidewalls to the weir opening does not affect the flow (*Tony L. Wahl, Bureau of Reclamation Hydraulics Laboratory in Denver, Colorado, USA*). The equations used by the XCi device's and reproduced [here](#) are used with permission of U.S. Dept. of the Interior, Bureau of Reclamation - Hydraulic Investigations and Laboratory Services Group.

For further information users are encouraged to visit the following website:

www.usbr.gov/pmts/hydraulics_lab/pubs/wmm/index.htm

Add a "Flowrate (using weir)"- channel type

1. When adding the "**New channel**" select the related "**Depth**" channel from the drop down list.

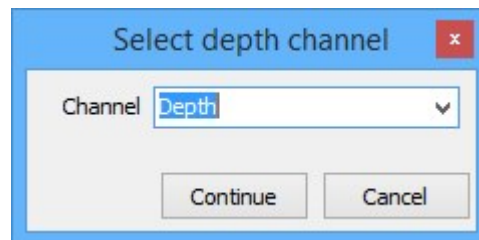

2. Select the weir type that you wish to configure. If you are setting up a flow rate through a Parshall flume, expand the "**Parshall flume**" weir type and select the appropriate flume width from the expanded list.

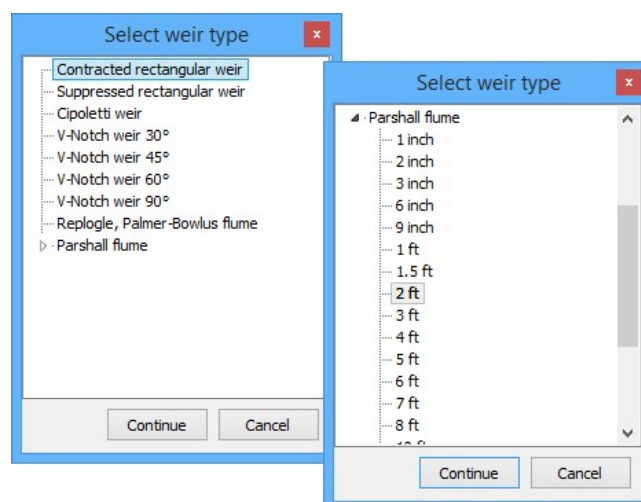

3. Click "**Continue**" and the "**Configure channels**" dialogue box will re-appear with the new channel listed.

Edit a "Flowrate (using weir) - channel type

Flowrate units

Select the units and the timebase from the drop down list boxes. This sets the units on the logged value.

Flowrate (Weir): Rectangular and Cipoletti weirs

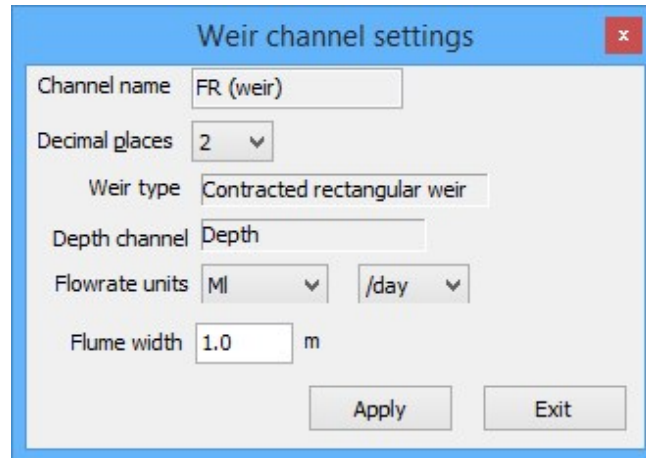

The screenshot shows a dialog box titled "Weir channel settings" with a close button (X) in the top right corner. The dialog contains the following fields and controls:

- Channel name: Text box containing "FR (weir)"
- Decimal places: Dropdown menu set to "2"
- Weir type: Text box containing "Contracted rectangular weir"
- Depth channel: Text box containing "Depth"
- Flowrate units: Two dropdown menus, the first set to "Ml" and the second set to "/day"
- Flume width: Text box containing "1.0" followed by a unit label "m"
- Buttons: "Apply" and "Exit" buttons at the bottom right.

"**Flume width**" - Enter the width of the weir in the units shown. The units are defined according to the "**System settings**".

Flowrate (Weir): V-Notch weirs (30°, 45°, 60°, 90°)



The screenshot shows a dialog box titled "Weir channel settings" with a close button (X) in the top right corner. The dialog contains the following fields and controls:

- Channel name: Text box containing "Flow Rate"
- Decimal places: Dropdown menu set to "2"
- Weir type: Text box containing "V-Notch weir 30°"
- Depth channel: Text box containing "Depth"
- Flowrate units: Two dropdown menus, the first set to "Ml" and the second set to "/day"
- Buttons: "Apply" and "Exit" buttons at the bottom right.

Flowrate (Weir): Replogle, Palmer-Bowlus flumes

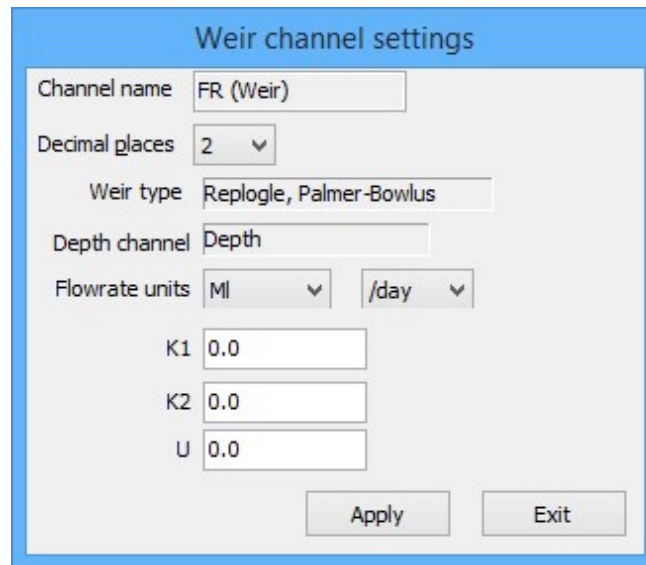

The screenshot shows a dialog box titled "Weir channel settings". It contains the following fields and controls:

- Channel name: FR (Weir)
- Decimal places: 2 (dropdown)
- Weir type: Replogle, Palmer-Bowlus
- Depth channel: Depth
- Flowrate units: Ml (dropdown) /day (dropdown)
- K1: 0.0
- K2: 0.0
- U: 0.0
- Buttons: Apply, Exit

"**Flume factors**" - Long-throated flumes are custom-designed. The values of **K1**, **K2**, and **U** are determined by the designer, using software such as **WinFlume** available from:

[WinFlume](#)

Flowrate (Weir): Parshall flume

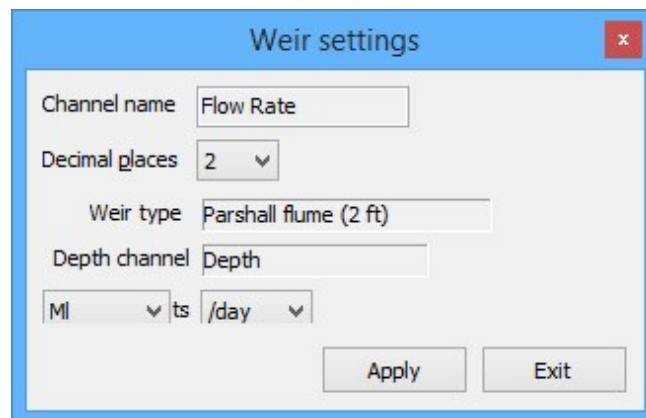

The screenshot shows a dialog box titled "Weir settings". It contains the following fields and controls:

- Channel name: Flow Rate
- Decimal places: 2 (dropdown)
- Weir type: Parshall flume (2 ft)
- Depth channel: Depth
- Flowrate units: Ml (dropdown) ts /day (dropdown)
- Buttons: Apply, Exit

"Flowrate (using trickle flow)" - channel type

This channel uses the Mannings formula to calculate velocity in a circular pipe based upon depth measurement from a MACE Area/Velocity sensor.

The Mannings equation, uses an algorithm to derive the "**Velocity**" of flow in a pipe based on depth, pipe gradient and a "roughness coefficient".

$$V = (\text{CoEff} / N) R_h^{2/3} \cdot S^{1/2}$$

Where:

V = Stream Velocity (ft/s, m/s)

CoEff = 1.49 for US units and 1.0 for metric units

N = Mannings roughness co-efficient (unitless)

R_h = Hydraulic Radius (ft, m)

S = Pipe slope (ft/ft, m/m).



WARNING: There are inherent inaccuracies with using the Mannings equation for calculating "**Velocity**". User should make themselves aware of the limitations of this method **PRIOR** to use.

Add a "Flowrate (using trickle flow)" - channel type



NOTE: The XCi implementation of the Mannings equation into a "**Flowrate (using trickle flow)**" channel uses the derived "**Velocity**" measurement used in conjunction with the "**Depth**" measurement **ONLY** from a MACE A/V Doppler sensor. A "**Flowrate (using trickle flow)**" - channel type can only be added after suitable Doppler "**Velocity**" and "**Depth**" channels have been added to the configuration.

1. After selecting the ""**Flowrate (using trickle flow)**" channel type and naming the new channel, the "**Select velocity channel**" dialogue box will appear prompting you to use the drop down list to highlight the "**Velocity channel**" from which the new "**Flowrate (using trickle flow) channel**" will receive its value.
2. Click "**Continue**" and the "**Select depth channel**" dialogue box will appear. In the "**Select depth channel**" dialogue box use the drop down list to highlight the "**Depth**" channel from which the "**Flowrate (using trickle flow)**" channel named will receive its value. Click "**Continue**" to complete

the new channel.

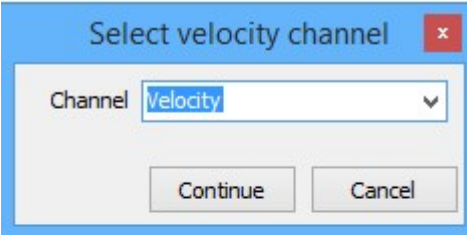

Select velocity channel

Channel: Velocity

Continue Cancel

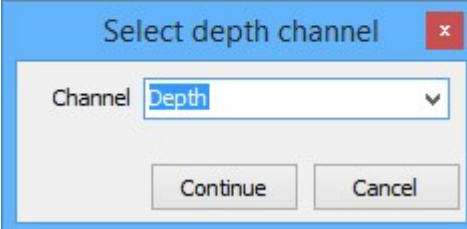

Select depth channel

Channel: Depth

Continue Cancel



NOTE: This channel uses the MACE Area/Velocity sensor in conjunction with the Mannings equation. This equation is limited to a depth of half-full circular pipe. When the pipe is more than half-full, the "Flowrate (using trickle flow)" channel will revert to using the standard continuity equation $Q = V \times A$.

Edit a "Flowrate (using trickle flow)" - channel type

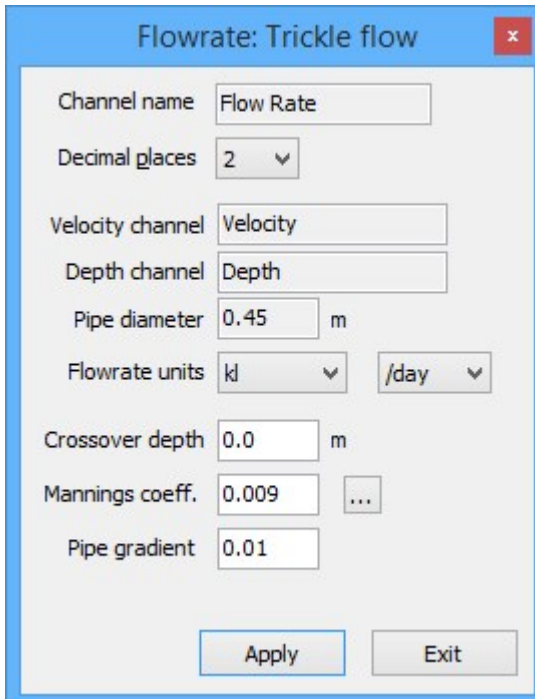

Flowrate: Trickle flow

Channel name: Flow Rate

Decimal places: 2

Velocity channel: Velocity

Depth channel: Depth

Pipe diameter: 0.45 m

Flowrate units: kl /day

Crossover depth: 0.0 m

Mannings coeff.: 0.009

Pipe gradient: 0.01

Apply Exit

Flowrate units

Select the units and the timebase from the drop down list boxes. This sets the units on the logged value.

Crossover depth

Enter the depth at which the "**Flowrate (using trickle flow)**" will "crossover" to using the "**Velocity**" value measured by the MACE Area/Velocity Doppler sensor.



NOTE: "*Crossover depth*" is limited to half the diameter of the pipe.

Mannings coeff.

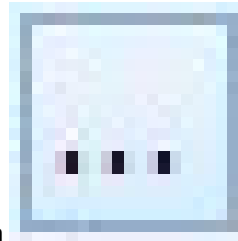

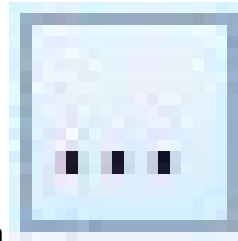
Enter the surface roughness of the pipe. Alternatively, click on  and select one of the published coefficients from the list.

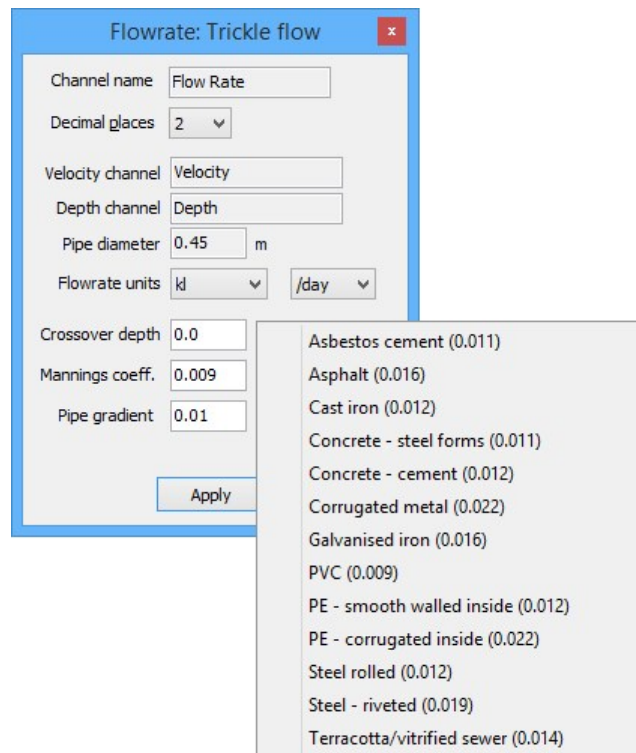

Material	Mannings Coefficient
Asbestos cement	0.011
Asphalt	0.016
Cast iron	0.012
Concrete - steel forms	0.011
Concrete - cement	0.012
Corrugated metal	0.022
Galvanised iron	0.016
PVC	0.009
PE - smooth walled inside	0.012
PE - corrugated inside	0.022
Steel rolled	0.012
Steel - riveted	0.019
Terracotta/vitrified sewer	0.014



WARNING: Users should be very careful to select the correct surface roughness coefficient for their pipe type. Major errors can be induced with incorrect use

Pipe gradient

Enter the "**Pipe gradient**" of the measuring site. This is calculated and entered as a decimal percentage. For example, a "**Pipe gradient**" of 1% should be entered as "**0.01**"

"Net flowrate" - channel type

This channel is used to calculate positive or negative flowrate based on the results obtained by addition or subtraction of two or more configured flow rate channels.

Add/Edit a "Net flowrate" - channel type

1. The "**Net Flowrate**" channel allows the user to add and subtract all configured "**Flowrate (of any type)**" channels.



NOTE: Only "**Flowrate**" channels with the same flowrate units can be included.



NOTE: Before proceeding, decide the order in which the "**Net flowrate**" channel will be calculated. This is important, as it dictates which "**Flowrate**" channel will be used to "**start**" the equation.

New Net Flowrate channel

Available flowrate channels

Flow Rate 1
Flow Rate 2
Flow Rate 3

Source channel(s)

(Max. 6 source channels)

Flowrate units:

Continue Cancel

2. Highlight the "**Available flowrate channel**" that will start the equation. Click the



button to move the channel to the "**Source channel(s)**" list and the "**Net flowrate channel options**" dialogue will appear.

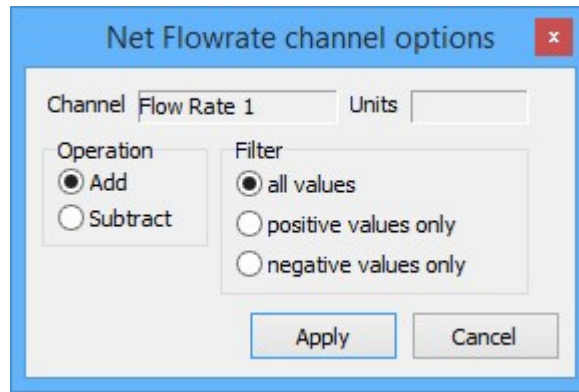

Operation

Check the radio button that matches the operation that you wish to perform on the subsequent "**Flowrate**" channel. In the example, the channel named "**Flow Rate 1**" will be moved to the "**Source channel (s)**" list and the subsequent "**Flowrate**" channel will be added to its value.

Filter

Check the radio button for the "**Flowrate**" channel values that you wish to include in the "**Net flowrate channel**". In the example, the channel named "**Flow Rate 1**" will be used, regardless of whether or not its channel value is positive or negative.

3. Click "**Apply**".
4. Continue to move the channels and edit their "**Net flowrate channel options**" until complete.

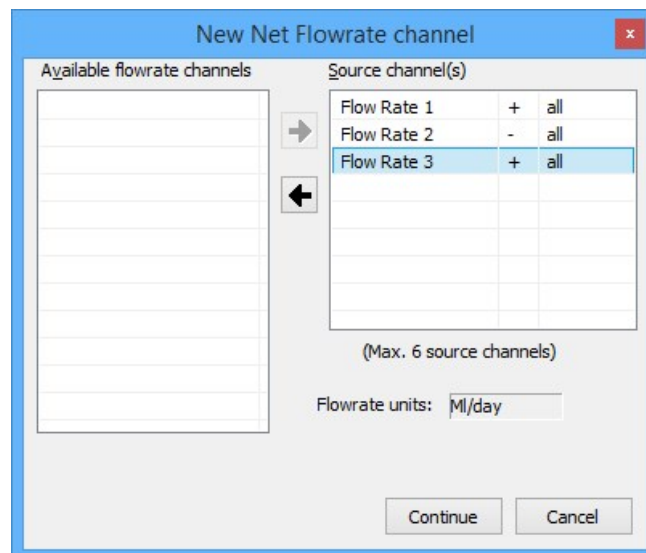



NOTE: In the example, the "*Net flowrate*" will be the sum of "*Flow Rate 1*" + "*Flow Rate 2*" - "*Flow Rate 3*"

"Total flow" - channel type

This channel is used to calculate an accumulated positive or negative total based on the results obtained from configured flow rate channel/s.

Add a "Total flow" - channel type

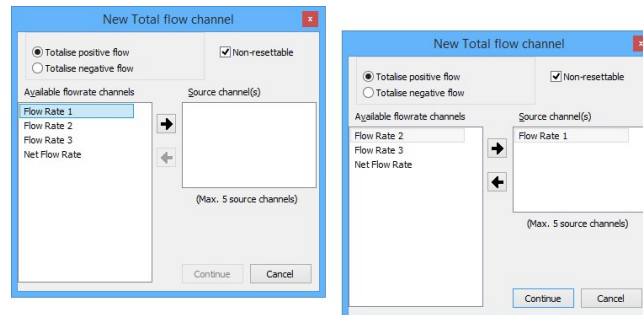

1. From the "**Available flowrate channels**" list, highlight the "**Flowrate**" channel from which the "**Total flow**" channel will receive its value. Click the "**Right arrow**" and the channel will appear in the "**Source channel(s)**" list. A maximum of five flowrate channels can be totalised together.
2. Select either "**Totalise positive flow**" or "**Totalise negative flow**" depending upon your application.



WARNING: The "**Totalise positive flow**" type will only increment the totaliser. If negative flows are recorded the totaliser will NOT decrement. The positive totaliser rolls over to zero.



WARNING: The "**Totalise negative flow**" type will only decrement the totaliser. If positive flows are recorded the totaliser will NOT increment. The negative totaliser rolls over to zero.



NOTE: Both positive and negative flow rates will be recorded in the data file.



NOTE: The "Totaliser" in the XCi device has nine (9) digits (including the user set decimal points).

It will rollover to zero after 999999999 *units*.

With decimal points it will rollover at:

99999999.9 or

999999.99 or

99999.999

3. If the "**Non-resettable**" checkbox is ticked, this total flow channel will not be re-settable using the "**Set/reset**" procedure from the "**View totals**" main menu item.



NOTE: If the "**Non-resettable**" checkbox is ticked, this total flow channel will not be re-settable using the front panel button press procedure.

4. Click "**Continue**" to complete the new channel and the "**Configure channels**" dialogue box will re-appear with the new channel listed.

Edit a "Total flow" - channel type

Total flow, positive, non-resettable

Channel name: Total

Decimal places: 2

Flow volume units: Ml

Flowrate channel(s): Flow Rate 1

Apply Exit

Flow volume units

Select the units from the drop down list box. This sets the units on the logged value.

"Net flow total" - channel type

This channel is used to calculate an accumulated positive or negative total based on the results obtained by addition or subtraction of two or more configured flow rate channels.

Add/Edit a "Net flow total" - channel type

1. The "**Net flow total**" channel allows the user to add and subtract all configured "**Flowrate (of any type)**" channels and accumulate a totalised value.



NOTE: Only "**Flowrate**" channels with the same flowrate units can be included.



NOTE: Before proceeding, decide the order in which the "**Net flow total**" channel will be calculated. This is important, as it dictates which "**Flowrate**" channel will be used to "**start**" the equation.

New Net Flow Total channel

Available flowrate channels

Flow Rate 1
Flow Rate 2
Flow Rate 3

Source channel(s)

(Max. 6 source channels)

Flowrate units:

Flow volume units: MI

Non-resettable

Continue Cancel

2. Highlight the "**Available flowrate channel**" that will start the equation. Click the



button to move the channel to the "**Source channel(s)**" list and the "**Net flowrate channel options**" dialogue will appear.

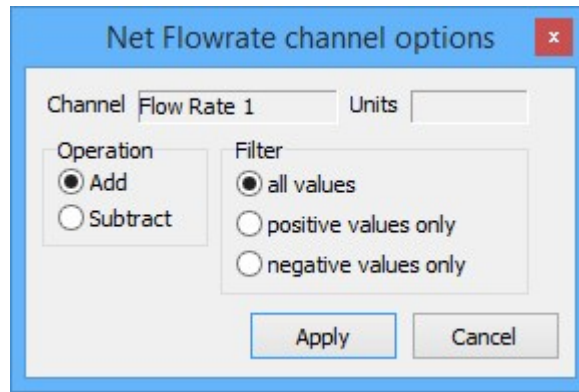

Operation

Check the radio button that matches the operation that you wish to perform on the subsequent "**Flowrate**" channel. In the example, the channel named "**Flow Rate 1**" will be moved to the "**Source channel (s)**" list and the subsequent "**Flowrate**" channel will be added to its value.

Filter

Check the radio button for the "**Flowrate**" channel values that you wish to include in the "**Net flow total channel**". In the example, the channel named "**Flow Rate 1**" will be used, regardless of whether or not its channel value is positive or negative.

3. Click "**Apply**".
4. Continue to move the channels and edit their "**Net flowrate channel options**" until complete.

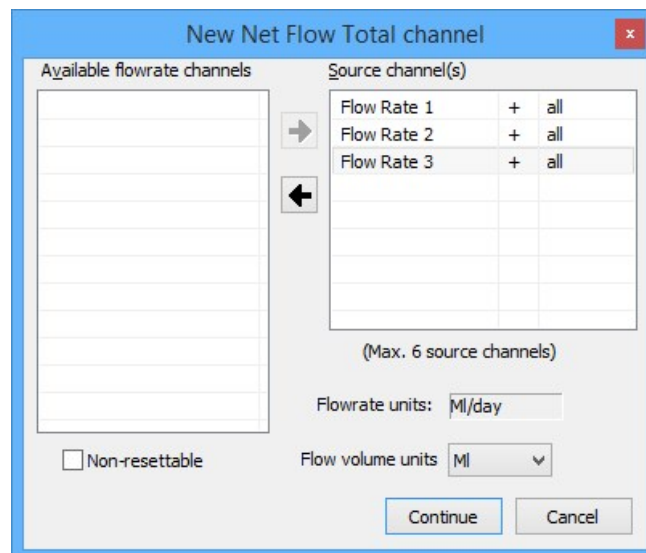



NOTE: In the example, the "*Net flow total*" will be the sum of "*Flow Rate 1*" + "*Flow Rate 2*" + "*Flow Rate 3*"

5. If the "**Non-resettable**" checkbox is ticked, this total flow channel will not be re-settable using the "**Set/reset**" procedure from the "**View totals**" main menu item.



NOTE: If the "**Non-resettable**" checkbox is ticked, this total flow channel will not be re-settable using the front panel button press procedure.

"Velocity (depth corrected)" - channel type

This channel is used to apply a correction factor to measured velocity data based upon different depth regimes of the stream.

Unfortunately, ideal hydraulic conditions cannot be achieved at every site that requires monitoring. If you are in a situation where hydraulic conditions are such that velocity calibrations at various flow regimes are required, then the "**Velocity (depth corrected)**" channel may help. Under abnormal hydraulic conditions, the average velocity of the stream must be calculated using traditional means that comply with international standards (refer to AS3778 series or ISO772). The calibration will need to be done at various depths and the calculated velocity/MACE Doppler velocity ratio determined. You can then apply the ratio to the data. For example, if you measure the average velocity of a stream to be 0.95m/s and the MACE Doppler velocity sensor is measuring 1.0m/s then the velocity ratio will be 0.95/1.0. (or 0.95). In the example below, a stream is measured at four depth regimes and four ratios have been determined. Situations such as a gravity type sewer with a bend upstream may result in the need to use this function. If the hydraulic conditions are reasonable at the site you choose to monitor then there is no need to use this function.

Add a "Velocity (depth corrected)" - channel type

1. After selecting the ""**Velocity (depth corrected)**" channel type and naming the new channel, the "**Select velocity channel**" dialogue box will appear prompting you to use the drop down list to highlight the "**Velocity channel**" from which the new "**Velocity (depth corrected)**" channel" will receive its value.
2. Click "**Continue**" and the "**Select depth channel**" dialogue box will appear. In the "**Select depth channel**" dialogue box use the drop down list to highlight the "**Depth**" channel from which the "**Velocity (depth corrected)**" channel named will receive its value. Click "**Continue**" to complete the new channel.

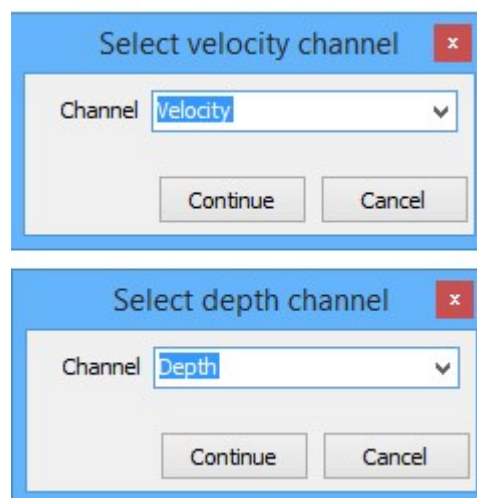

Edit a "Velocity (depth corrected)" - channel type

Edit depth corrected velocity channel ✕

Channel name

Decimal places

Velocity channel

Depth channel

Velocity factors

No. of zones

Zone	Factor	Upper depth limit
1.	<input type="text" value="1.0"/>	(Max. depth)
2.	<input type="text" value="0.95"/>	<input type="text" value="0.8"/> m
3.	<input type="text" value="1.05"/>	<input type="text" value="0.7"/> m
4.	<input type="text" value="1.01"/>	<input type="text" value="0.3"/> m

No. of zones

Enter the number of "flow regimes" that have had velocity calibrations performed. A maximum of four (4) zones is applicable

Factor

The calculated ratio to be applied to the "**Velocity**" channel data.

Depth

Enter the zone depth limits here. For example,

"**Factor ratio**" for "**Zone 4**" will be applied for stream depths between zero (0) and 0.3m.

"**Factor ratio**" for "**Zone 3**" will be applied for stream depths between 0.3m and 0.7m.

"**Factor ratio**" for "**Zone 2**" will be applied for stream depths between 0.7m and 0.8m.

"**Factor ratio**" for "**Zone 1**" will be applied for stream depths between 0.8m and maximum depth.



NOTE: All depths as measured by the associated "**Depth**" channel

"Volume (using lookup table)" - channel type

This channel is used to calculate the volume of a storage (dam/tank) based upon a depth measurement and a user configured lookup table of the storage geometry.

Add a "Volume (using lookup table) - channel type

1. When adding the "**New channel**" select the related "**Depth**" channel from the drop down list.

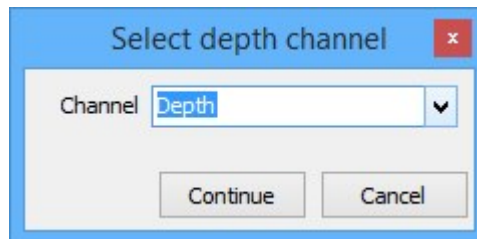

2. Click "**Continue**" and the "**Configure channels**" dialogue box will re-appear with the new channel listed.

Edit a "Volume (using lookup table) - channel type

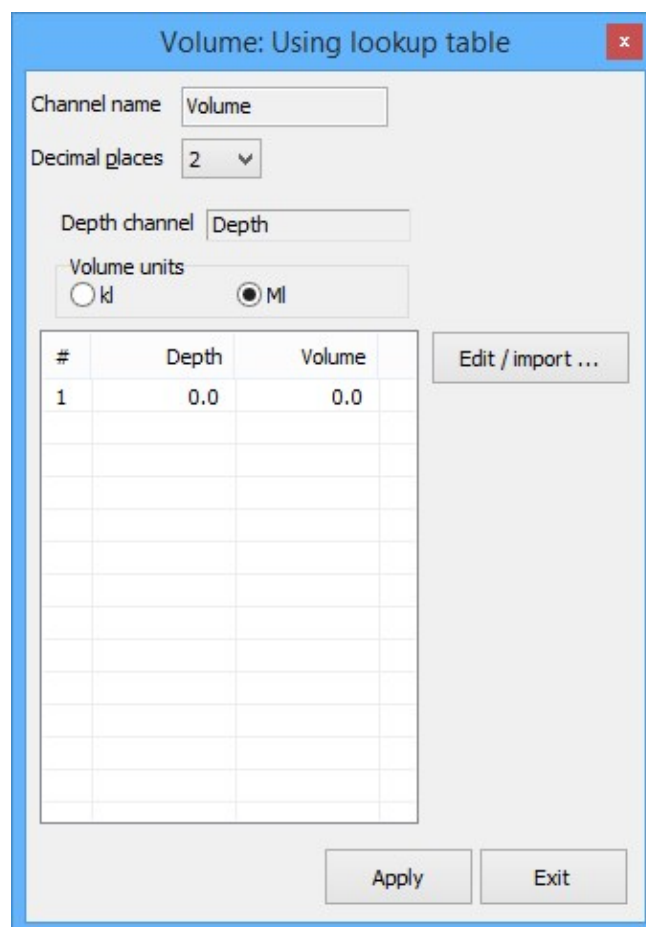

Volume units

Select the units using the radio buttons. This sets the units on the logged value.

Lookup table values

Lists the volumes that will be calculated at the corresponding measured depths.



NOTE: The lookup table has a maximum of 50 lines available for use. This maximum is memory dynamic and may be reduced depending upon other channel configurations.

Edit/import

1. From the "**Volume: Using lookup table**" dialogue box click "**Edit/import**" and the "**Edit/import LUT data**" dialogue box will appear.
2. Lookup table values can be entered here directly. The depth and corresponding volume values must be separated by a comma (,).

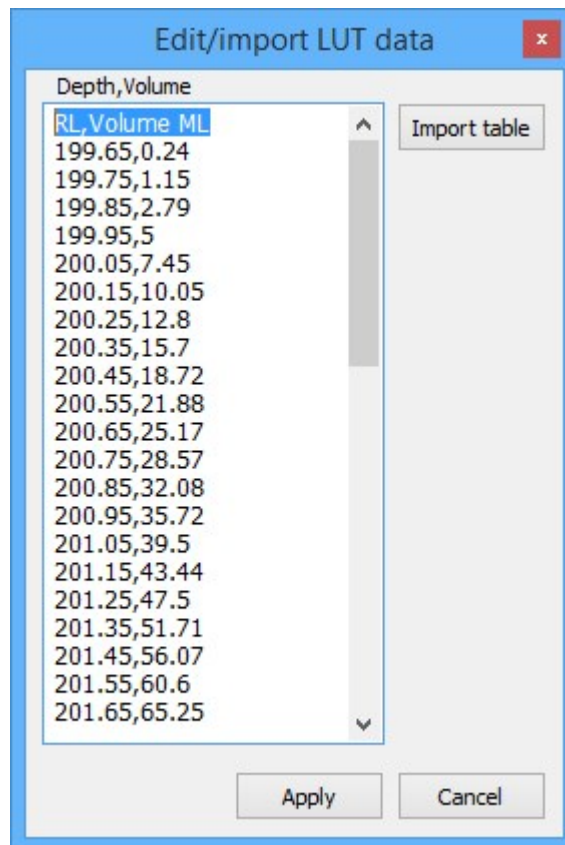

- Alternatively, values may be imported from a *.CSV file. Click "**Import table**" and a Windows® "**Open**" dialogue box will appear prompting the selection of a *.CSV file. Click "**Open**" and the values will be imported.



NOTE: The *.CSV table should be in the format of two columns, one for "**Depth**" and the other "**Volume**". Any text in the data will cause a "parsing" error and should be removed for successful import.

- Click "**Apply**" and the "**Volume: Using lookup table**" dialogue box will appear containing the updated values.

#	Depth	Volume
1	199.65	0.24
2	199.75	1.15
3	199.85	2.79
4	199.95	5.0
5	200.05	7.45
6	200.15	10.05
7	200.25	12.8
8	200.35	15.7
9	200.45	18.72
10	200.55	21.88
11	200.65	25.17
12	200.75	28.57
13	200.85	32.08
14	200.95	35.77

"Device battery voltage" - channel type

This channel is used to monitor the XCi device internal battery voltage.



"Device external voltage" - channel type

This channel is used to monitor the XCi device external voltage from a solar panel or mains charger.

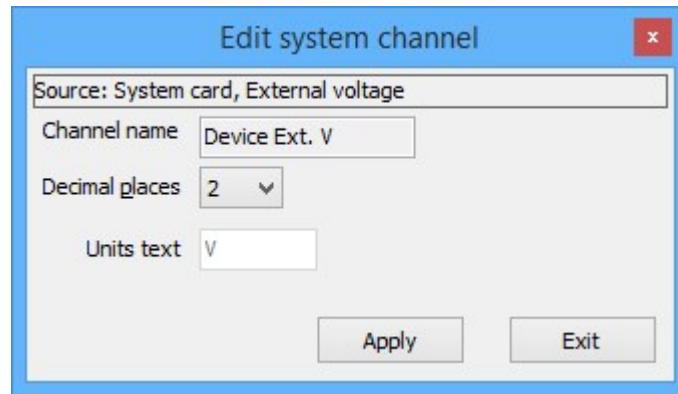

The image shows a software dialog box titled "Edit system channel" with a red close button in the top right corner. The dialog contains the following fields and controls:

- A text box at the top containing "Source: System card, External voltage".
- A "Channel name" label followed by a text box containing "Device Ext. V".
- A "Decimal places" label followed by a dropdown menu showing the number "2".
- A "Units text" label followed by a text box containing "V".
- At the bottom right, there are two buttons: "Apply" and "Exit".

"Doppler sensor check" and interpreting real-time data

Doppler Sensor Check

1. From the "**Edit configuration settings**" dialogue, click "**Doppler sensor check**" and the "**MACE Doppler real time data**" dialogue box will open.
2. Highlight the channel that you wish to observe, click "**Display**" and the "**Real time display**" will open.

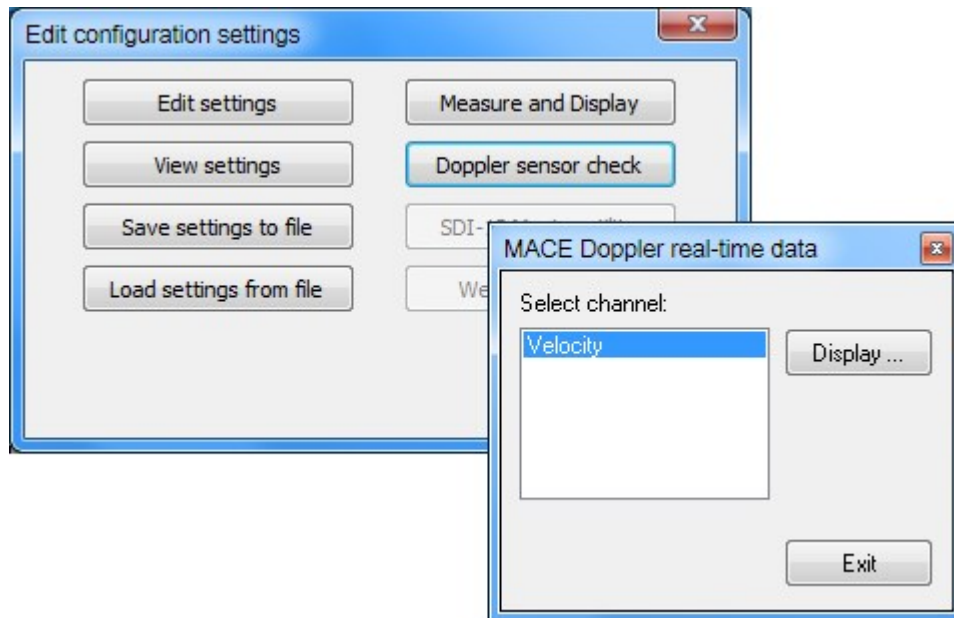

3. Should you wish to save Real Time graphs in a file check the "**Save data to file**" check box.
4. Click "**Start**" to begin measurements. If you checked "**Save data to file**" a Windows® "**Save As**" dialogue box will appear. Save the file to a location of your choice and Doppler measurements will start.



NOTE: MACE recommends that the user views/saves at least 10 real time graph measurements.



NOTE: Wherever possible, real time graphs of both non-flowing and flowing conditions should be observed. This will enable the user to adjust the various filter settings accordingly.

5. When you have viewed/saved sufficient graphs, click "**Stop**" to end measurements then "**Exit**" to return to the main menu.

So what makes up a "Real-time graph"?

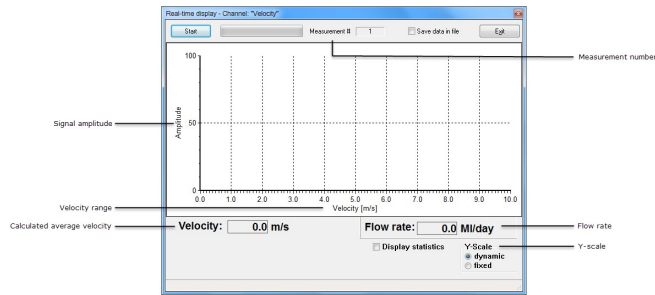

Signal amplitude

Relative strength of the signal received by the Doppler card from each velocity sensed in the spectrum.

Velocity range

The range set by the user over which velocities will be sensed in the spectrum.

Calculated average velocity

The average stream velocity calculated for the current measurement.

Depth measurement

The average stream depth (if measured) calculated for the current measurement.

Flow rate

The current flow rate if a "**Flowrate (using velocity)**" channel type has been configured for calculation using this "**Velocity**" measurement.

Display statistics



NOTE: MACE diagnostic use only

Y-scale

Dynamic - The y-axis of the real-time graph will change with each consecutive velocity measurement to match the amplitude of the signal.

Fixed - The amplitude of the graph stays set at the value received from the first real-time velocity trace. This amplitude does not change thereafter. It allows a more "visual" representation of the changing amplitude.

Measurement number

The number of real time graph measurements taken since "**Start**".



NOTE: The above screen shot is an example of a real-time graph captured when the stream is **NOT** flowing.

Interpreting real-time data

MACE XCi devices measure average stream velocity using Doppler ultrasonic technology. Anything moving in the stream, which is acoustically reflective, may produce an echo and therefore a Doppler shift.

Acoustically reflective particles include:

- Suspended solids;
- Bubbles, eddies and waves;
- Larger particles such as, sand, leaves and pebbles.

When selected in FloCom+, the user can display a real-time graph of the velocity spectrum received by the velocity sensor. The histogram you see in real-time data is a composite spectrum of the velocities of the stream flow as well as various other factors explained below.

- The graph is two dimensional (X-Y).
- The X-axis is the velocity (range set by user).
- The Y-axis (vertical) is the strength of the signal received by the processing electronics from each velocity sensed in the spectrum.
- Several thousand data points are plotted to give the composite graph.

MACE XCi devices measure several thousand data points and compute an average velocity. The flow is then calculated using the formula:

$$Q=V \times A$$

where: Q= Quantity, V= Stream velocity and A= Cross-sectional area.

Users of MACE XCi devices can use the real time graph to determine the correct positioning of the velocity sensor by assessing the shape of the curve and the signal strength. The following graph is an example of a spectrum that was received from a full pipe irrigation flow. Under field conditions, several factors can affect the spectrum without affecting the performance or accuracy of the velocity sensor.

Armed with an understanding of these factors and some field experience, the operator can vary the position of the sensor and the system settings to correct site induced errors in the velocity readings.

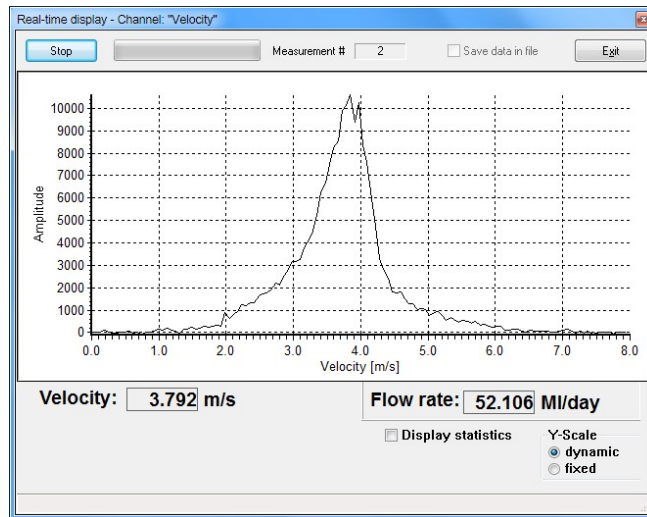

This real-time graph displays an ideal "bell shape" centred across the velocity range. The range has been set to double the average velocity. This enables all velocities across the range to be captured.

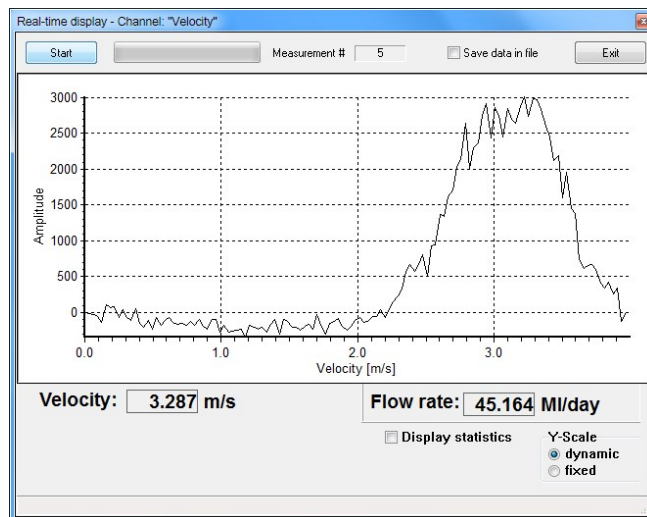

This real-time graph displays a situation where the velocity range has not been set correctly for the site conditions. Velocities exceeding the set range are not being captured. Furthermore, the velocity readings that are missed WILL cause the processing electronics to alias and the overall average velocity calculated will be unreliable. The range MUST be set to at least double the average velocity. This enables all velocities across the range to be captured.

Factors affecting the velocity sensor

This chapter is designed to give the operator a brief understanding of some of the factors affecting the performance of the MACE Doppler ultrasonic velocity sensor/s.

In flowing streams, there are always a range of different velocities present, particularly in turbulent water where the effects of eddies and boundary layers can cause the velocity histogram to appear distorted in the diagram below. Although distorted, MACE XCi devices have powerful signal processing algorithms, which determine the average stream velocity from these signals.

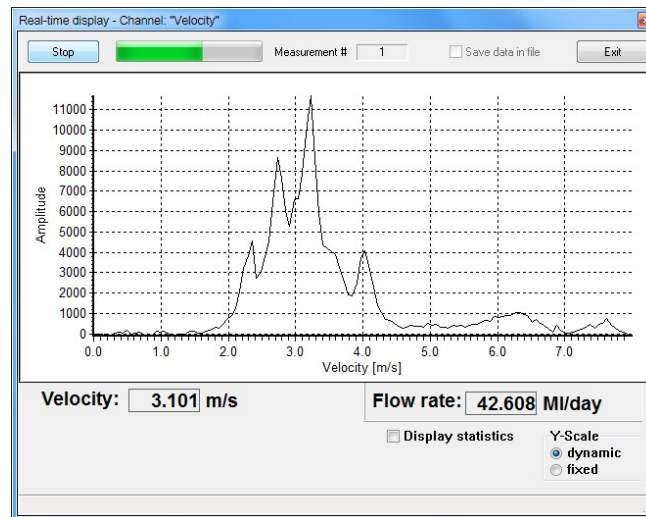

If the operator is receiving data such as displayed in the diagram above, the sensor may be moved slightly to try to overcome the distortion. Furthermore, the operator should inspect the positioning of the sensor to ensure that there is not a build-up of debris or other matter, close to the sensor head. If no obstruction is observed and re-positioning the sensor does not improve the data, you can be assured that the sensor is operating effectively and that the displayed data is a site induced phenomenon.

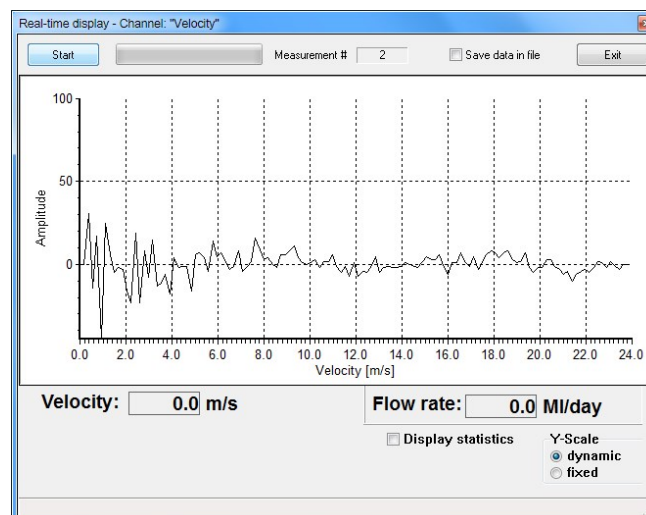



WARNING: *If data such as that seen above is received, the operator should ensure that the sensor is positioned correctly and monitor the site for any obstructions close to the sensor. If no obstructions are located close to the sensor, the site may be unsuitable for flow measurement with Doppler ultrasonic flow sensors.*

The signal strength of received echoes on the real-time histograms, is a measure of the number of reflective particles moving in the stream. Therefore, low signal strengths do not necessarily equate to poor velocity readings. Relatively few particles may provide enough echoes for an accurate average velocity reading. Furthermore, a histogram with a broad base will generally tend to have a peak with a lower signal strength. In sites where it is suspected that there are relatively few reflective particles in the flow, the period in which the XCi devices takes readings may require extending (see, Integration Period).

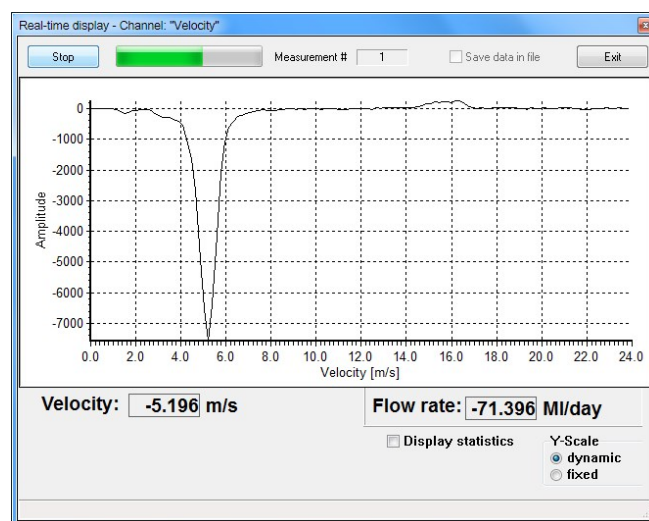

This real-time graph displays velocities captured by a sensor facing downstream. Although the amplitude of the graph is negative the calculated average velocity is positive because the "Sensor orientation" has been set to "Downstream" in the Doppler module configuration.

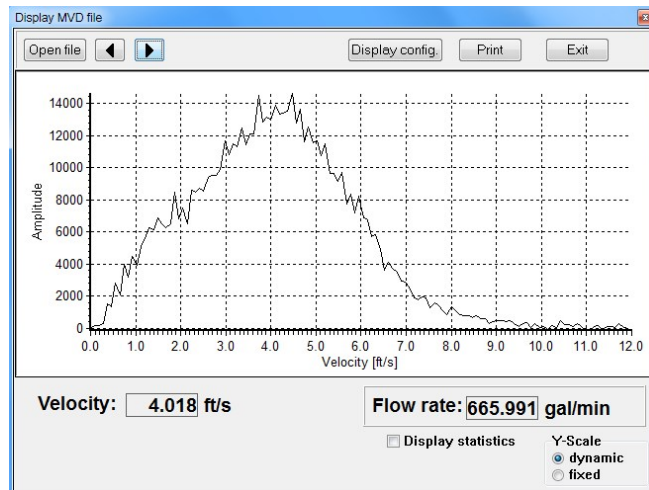

This real-time graph displays velocities captured by a sensor at a wastewater pump site. Pumped flows typically exhibit graphs with a broader base than gravity flows.

A general rule of thumb, if a spectrum has low signal strength but gives a consistent velocity reading, then the measurements should be accurate. However, if the spectrum has low signal strength and gives inconsistent velocity readings or none at all, the site may be unsuitable for flow measurement with Doppler ultrasonic flow sensors.

Very distorted signals such as that described in the diagram on the previous page may result from interference to the velocity sensor by the build-up of debris or siltation.

In sites where there is an expectation of sedimentation, the velocity sensor should be mounted in a raised position. In a full-pipe application, it is recommended that the sensor be mounted (or inserted) on the side of the pipe to avoid sedimentation.

Similarly, in partially full pipes, the sensor may be offset from the invert of the pipe. In these instances, the depth reading will need to be offset accordingly.

Covering the sensors with algae and other materials that are saturated generally does not affect the accuracy of velocity readings. This is because saturated materials exhibit the same speed of sound as water.

MACE XCi devices include several signal processing features specifically designed to overcome anomalous data produced by such phenomena as: aquatic life (fish, weeds, small invertebrates); surface waves (produced by turbulence and wind); and background noise.



NOTE: It should always be remembered when examining real-time graphical data, that settings within the unit itself can have a marked effect on the data displayed. The configuration of the instrument should always be checked thoroughly before viewing real-time data.

For a short video of the procedure click "**Play**"-

"Measure and Display" function

The "**Measure and Display**" function enables the user to check that all XCi channel types configured are "working". This function will update the channel values based upon the longest time period that a particular channel configuration requires to output a value. For example, if a depth sensor requires a 25 second "warm-up", then the values will be updated every 25 seconds. If a Doppler "**Velocity**" channel requires 30 seconds to calculate a velocity, then the values will be updated every 30 seconds and so on.

1. From the "**Edit configuration settings**" dialogue, click "**Measure and Display**" and the "**View measurement**" dialogue box will open.

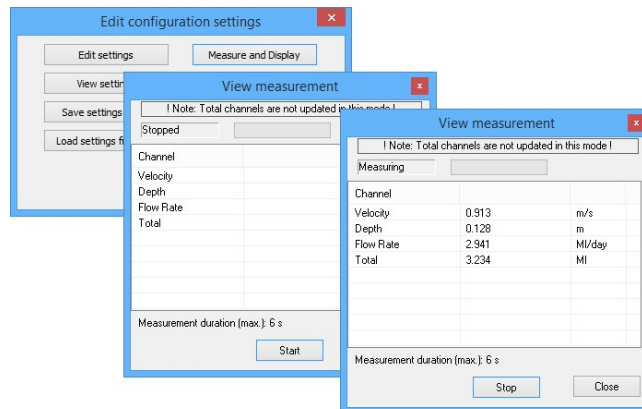

2. Click "**Start**" and the progress bar at the top will begin to advance every second.
3. After all "**Channels**" have been received and/or calculated the "**Channel**" values will be updated.
4. Click "**Stop**" then "**Close**" to return to the "**Edit configuration settings**" dialogue.



NOTE: "Total" channels are not updated in "Measure and Display"

For a short video of the procedure click "**Play**"-

"Offset adjust" function

This function is used to "fine tune" a sensor reading whenever a sensor is deployed or reading inaccurately. For example, a depth sensor may be sitting slightly off the bottom of the stream, or the user has deployed it above a silt line on the side of a pipe.

1. Click "**Offset adjust**" from the "**Edit channel**" dialogue box and the "**Channel offset adjust**" dialogue box appears.

The "**Current value**" from the sensor (in this case a depth sensor with frequency output) is displayed at the top of the window and is updated approximately once per second.

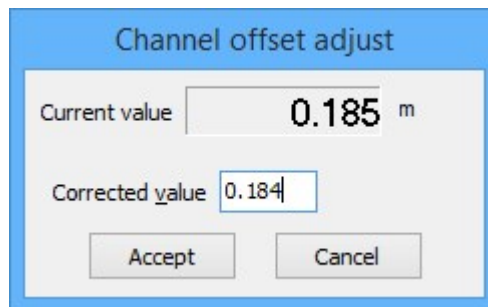

Channel offset adjust

Current value m

Corrected value

2. To adjust the "**Current value**", enter your current measured value in the "**Corrected value**" field.
3. Click on the "**Accept**" button to calculate the new "**Offset**" parameter value for the associated channel. Clicking on the "**Cancel**" button terminates the procedure without altering the offset value.

For a short video of the procedure click "**Play**"-



WARNING: When calibrating a "Depth" channel, measurements should ALWAYS be carried out from the bottom of the channel/pipe to the top of the water level

"2-Point Calibration" function

To correctly calibrate an environmental sensor it is important to calibrate it over its useful range. For example, if a depth sensor has a range of 0 - 2 metres but you only wish to use it to measure the range 0.0 metres to 1.25 metres, you should re-calibrate it across the reduced range.

1. Click "**2-point calibration**" from the "**Edit channel**" dialogue box and the "**2 point calibration**" dialogue box appears.

The "**Current value**" from the sensor (in this case a depth sensor with frequency output) is displayed at the top of the window and is updated approximately once per second.

2. To carry out a two point calibration, prepare the measurement set up for the first calibration point (either the sensors upper or lower range limit).
3. When the "**Current value**" has stabilised, click on the "**Set**" button in the "**1st point**" box. The "**Current value**" is copied to the "**Measured value**" field of the "**1st point**" box and the "**Actual value**" field is enabled.

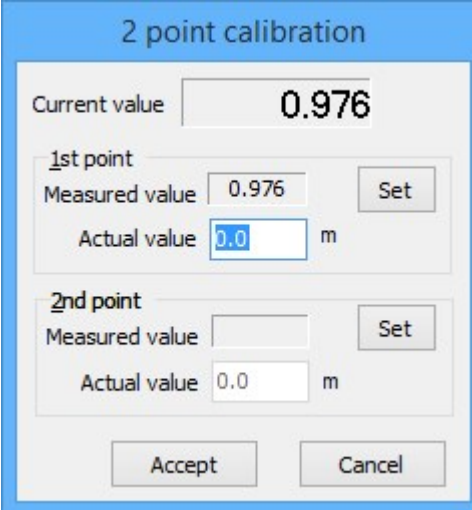

The screenshot shows a dialog box titled "2 point calibration". At the top, "Current value" is displayed as 0.976. Below this, there are two sections for calibration points. The "1st point" section has a "Measured value" field containing 0.976 and a "Set" button. The "Actual value" field is set to 0.0 m. The "2nd point" section has an empty "Measured value" field and a "Set" button. The "Actual value" field is set to 0.0 m. At the bottom of the dialog are "Accept" and "Cancel" buttons.

4. Enter the sensors actual value (in this case depth) in the "**Actual value**" field.
5. Prepare the measurement set up for the second calibration point (the opposite sensor range limit from that used in point 2 above). For example, if you used the upper range limit in point 2, now use the lower range limit.
6. When the "**Current value**" has stabilised, click on the "**Set**" button in the "**2nd point**" box. The "**Current value**" is copied to the "**Measured value**" field of the "**2nd point**" box and the "**Actual value**" field is enabled.

2 point calibration

Current value

1st point

Measured value

Actual value m

2nd point

Measured value

Actual value m

7. Enter the sensors actual value (in this case depth) in the “**Actual value**” field.
8. Click on the “**Accept**” button to calculate the new slope and offset parameter values for the associated channel. Clicking on the “**Cancel**” button terminates the procedure without altering the parameter values.

For a short video of the procedure click "**Play**"-

Troubleshooting the XCi



NOTE: This "Troubleshooting Guide" provides a summary of the most common "problems" that users report. Please contact your local MACE representative if you encounter an issue not covered in this guide.



NOTE: If seeking assistance from a local MACE representative for "site" related issues with an XCi device the following files **WILL** be needed:

1. Download device and save data file
2. Save the "Settings" of the device
3. If a Doppler card/sensor is present:
 - a) Run "Doppler sensor check"
 - b) Save at least 10 real-time graphs into an *.mvd file, preferably with both no flow and flow present

These instructions are also on a label inside your XCi device

Email files to your MACE representative.

I can't "Connect" to my XCi with FloCom+

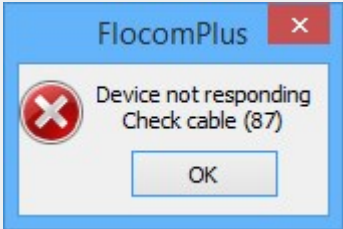
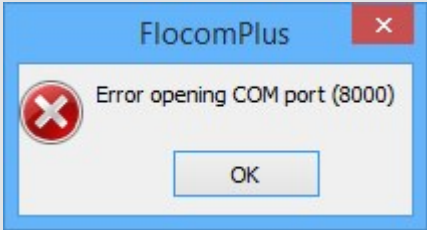
Symptom	Cause	Remedy
	MACE USB comms cable not connected to the XCi device	Plug in cable
	Cable is plugged into a different USB port to that used when cable installed	Try another USB port
	XCi has flat battery	Check battery, replace if necessary
	Sensor (SM) Bus error	Re- initialise XCi device
	Faulty controller card	Return to MACE for service
	MACE USB comms cable not connected to the USB port	Plug cable into USB port of PC
	Cable is plugged into a different USB port to that used when cable installed	Try another USB port
	Driver for USB cable not installed	MACE USB cable driver installation
	Incorrect driver for USB cable	Download/install correct driver

Symptom	Cause	Remedy
	installed	
	USB port of PC inactive	Unplug/replug cable from USB
	MACE cable available but " Always use MACE cable if present " unchecked	Check "<u>Always use MACE cable if present</u>"
	Incorrect password has been used to " Connect "	Check the password or follow the procedure, What to do if the password is lost/forgotten
	No/incorrect comm port selected	Select correct comm port
	No/incorrect comm port selected	Select correct comm port

My XCi has power problems



WARNING: Before troubleshooting power problems, ensure that you've pressed a button on the front of the enclosure to "wake-up" the XCi device. The most common "reason" for a perceived power issue is that the LCD "appears" to be dead.

Symptom	Cause	Remedy
Low/Flat battery (consistently <12 V)	Old battery	Replace battery
	Weak or no solar charge	Check solar panel undamaged
		Check solar panel for dirt and clean if necessary
		Check solar panel is plugged in
		Check wiring of solar panel is correct (polarity)
		Check XCi charging circuit
	No external power	Check trickle charger is plugged in
		Check trickle charger is turned on
		Check wiring of trickle charger is correct (polarity)
	Measurement interval too short	Increase measurement interval
Integration period too long	Decrease integration period	
Too many sensors for power supply	Check the "Power consumption guide"	
None of the above XCi must be drawing high current	Return to MACE for service	

My meter isn't reading the right flow rate!

Symptom	Cause	Remedy
My meter is over reading!	Incorrect pipe diameter entered in device configuration	Enter correct pipe diameter
	Incorrect pipe diameter units (US ONLY)	Check you've not mixed up "ft" with "in" or <i>vice versa</i>
	Pipe has silt in the bottom	Check/clear silt from pipe
	Velocity range not set correctly	Ensure velocity_range set to recommended level
	Sensor installed too close to undershot gate	Check installation_guidelines and rectify
My meter is under reading!	Incorrect pipe diameter entered in device configuration	Enter correct pipe diameter
	Incorrect pipe diameter units (US ONLY)	Check you've not mixed up "ft" with "in" or <i>vice versa</i>
	Insert sensor not installed far enough into pipe	Check insertion_depth and rectify
	Insert sensor not installed perpendicular to flow	Check sensor_installation and rectify
My meter is reading negative flows!	Sensor is installed facing downstream	Check installation orientation of sensor
	Sensor is installed facing downstream	Change sensor_orientation in FloCom+
	Velocity range not set correctly	Ensure velocity_range set to recommended level
	Leaking gate/foot valve	Check seals of gates and valves
My meter is NOT reading flow when it IS flowing!	XCi device not " Started "	Start device using FloCom+
	Doppler sensor is covered with trash	Check sensor for trash and clear

Symptom	Cause	Remedy
	Integration period not long enough to collect data	Increase " <i>Integration period</i> "
	Insufficient acoustic targets at site	Read " Site selection " guidelines
My meter IS reading flow when it's NOT flowing!	Normally occurs due to moving water - leaky gate, foot valve	Check seals of gates and valves
	Entrapped aquatic life in pipe	Adjust " Filters " using FloCom+
	Water "sloshing" in pipe around sensor level	Make sure water level recedes fully, or pipe stays completely full
	Electromagnetic interference (EMI) causing false "flow"	Find source of EMI and rectify if possible

My meter "*Total*" isn't right

Symptom	Cause	Remedy
My meter total "creeps" up	Normally occurs due to moving water - leaky gate, foot valve	Check seals of gates and valves. Consider installing a second gate to isolate the system.
	Entrapped aquatic life in pipe	Adjust " Filters " using FloCom+
	Water "sloshing" in pipe around sensor level	Make sure water level recedes fully, or pipe stays completely full. Consider installing a second gate to isolate the system.
	Electromagnetic interference (EMI) causing false "flow"	Find source of EMI and rectify if possible
My total is not increasing	Total channel set up as " Negative only "	Check " Total " in FloCom+
My total is not decreasing	Total channel set up as " Positive only "	Check " Total " in FloCom+
I can't reset the total	Total channel has been set up as " Non-resettable "	Check " Total " in FloCom+
My total "rolls over" too quickly	Total units are too small for application	Change total_units to larger units
My total is wrong!	Total units are not what's expected	Check total_units in FloCom+
	Total has "rolled over" without me realising it!	

My XCi has problems measuring the depth

Symptom	Cause	Remedy
Depth readings respond slowly to changes in actual depth	Reference filter has not been " Enabled "	"Enable" reference filter
	Reference line has been crimped	Check reference line for crimps
	Sensor cable has been squashed	Look for possible signs of cable compaction
Depth readings seem to be inaccurate	Incorrect units (US only)	Check that units are in your desired ft or in
	Slope/offset incorrectly entered	Check slope/offset entered correctly
	Slope/offset units wrong	Check that slope/offset units are correct off the tag
	Slope/offset calculated incorrectly	Check calculation of slope/offset
Depth does not change	Damaged depth sensor	Check for damage and replace ceramic module
Depth reading is always the offset	Depth sensor not connected properly	Check connection inside XCi
	Damaged depth sensor	Check for damage and replace ceramic module
Depth sensor stays at full-scale	Damaged depth sensor	Check for damage and replace ceramic module

My XCi has problems measuring velocity

Symptom	Cause	Remedy
No velocity reading	Doppler sensor not plugged into card	Check connections
	Faulty sensor	Follow test procedure and if damaged Return to MACE for service
	Faulty Doppler card	Return to MACE for service
Velocity drops out at low depth	Depth too low for measurement	Sensor needs at least 50mm depth
	Doppler sensor is covered with trash	Check sensor for trash and clear
	Hydraulic jump on top of sensor	Use " Surface-wave rejection " method
Velocity drops out at high depth	Velocity is too slow. Slow flow causes acoustic targets to drop out of suspension	Check by throwing some "dirt" into the flow. If velocity stabilises, the water may be unsuitable for Doppler ultrasonics
	Integration period not long enough to collect data	Increase " Integration period "
	Doppler sensor is covered with trash	Check sensor for trash and clear

Symptom	Cause	Remedy
"Sensor error" on LCD in log file in "Measure & Display"	Sensor (SM) Bus error	Re-initialise XCi device
	Doppler sensor not plugged into card	Check connections
	Corrosion in sensor connector	Check for corrosion and replace if necessary
	Sensor cable damaged	Check for physical damage, cuts in cable etc.
	Faulty sensor	Follow test procedure and if damaged Return to MACE for service
Velocity readings are negative	Sensor is installed facing downstream	Check installation orientation of sensor
	Sensor is installed facing downstream	Change sensor orientation in FloCom+
	Velocity range not set correctly	Ensure velocity range set to recommended level

My XCi has problems when I'm connected to FloCom+

Symptom	Cause	Remedy
Unsupported firmware version	An old version of FloCom+ is being used	Download latest version of FloCom+
Unsupported device function	Firmware version of XCi is older than FloCom+ and you are trying to access new functionality	Update XCi firmware
Card is physically installed in a different Slot# than FloCom+ "thinks"	Error on microprocessor bus	<ol style="list-style-type: none"> 1. "Disconnect" from XCi, remove all power inc. battery and solar panel. 2. Wait 1 min. 3. "Connect".
When connected with FloCom+ there is no date/time displayed in the system area	Corruption in reading clock	<ol style="list-style-type: none"> 1. "Disconnect" from XCi, remove all power inc. battery and solar panel. 2. Wait 1 min. 3. "Connect".
SM bus error	Error on microprocessor bus	Re-initialise XCi device

How to update XCi firmware

From time to time, MACE releases new firmware to enhance functionality and improve product stability/reliability. These new firmware releases are notified by an email sent to "**Registered users**" of the MACE website who have subscribed to the "**Software mailing list**".



NOTE: MACE strongly recommends that users register for Software Updates on the "Support" page of the [MACE Website](#). Releases of product enhancements occur periodically and we recommend that these are uploaded into your XCi device.



NOTE: Depending on the changes to firmware, often a **NEW** version of FloCom+ will **ALSO** need to be [installed](#). You will be informed of this requirement in the email notification.



WARNING: If your device is still running [V1.X.X.X firmware](#) please contact your local MACE representative. You **CANNOT** run this simple firmware procedure.

Prior to upgrading

1. When notified, login to the MACE website, download and save the latest firmware. Ensure you know the location of the saved file.
2. "[Connect](#)" to the device and "[Download](#)" data.
3. "[Stop](#)" device.
4. Click on "[View totals](#)" and write the relevant channel totals down. These may be needed when re-entering the channel information after the upgrade.
5. Click on "**Settings**", then save the device configuration by clicking "**Save settings to file**" and follow the prompts.
6. "**Disconnect**" from FloCom+.



WARNING: **DO NOT** physically disconnect the USB communications cable from the device you are upgrading.



NOTE: You are now ready to upgrade the firmware in the HVFlo XCi device.

Running the upgrade

Locate the program executable you saved "**MACE Flo3 Update XXXXXX.exe**", double-click to "**Run**" and the "**Flo Series3 Updater**" will open.

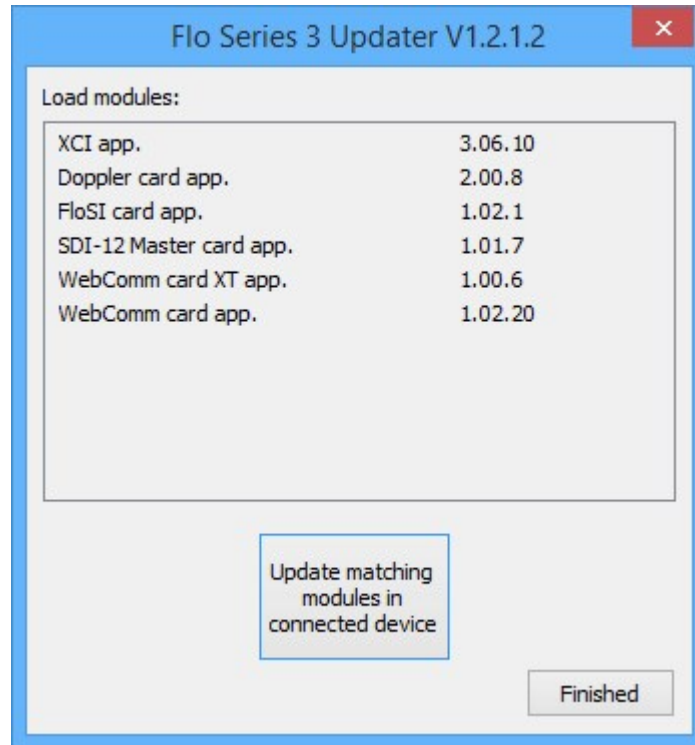

NOTE: The Flo Series3 Updater includes update apps for all field upgradeable FloSeries3 cards. Your system may or may not have applicable cards installed. The updater will only load firmware into cards in your device.

1. Click "**Update matching.....device**" and the matching cards in the HVFlo XCi device will be upgraded.
2. Where applicable, the XCi system firmware in the "**Controller card**" will be the first to update. You will be asked to confirm your intentions.

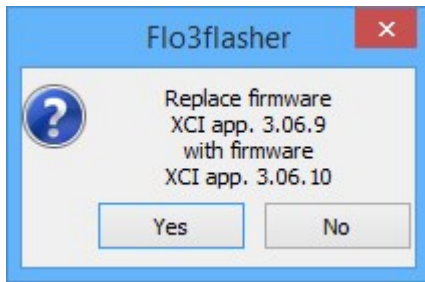

3. If applicable, the other cards will be updated with a similar process. You will be asked to confirm each card update process. Each card update will be run separately. For example, if you have more than one Doppler card, you will be asked to confirm the update process for each card.



4. After all cards have been updated to the firmware versions listed, the program will confirm that the update is complete.

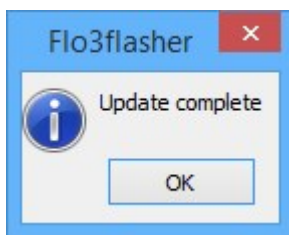

5. You will be returned to the "**Flo Series3 Updater**" dialogue box. Click "**Finished**" to exit from the program.

After the upgrade

1. "**Connect**" to the HVFlo XCI device with FloCom+.
2. Re-configure your instrument, either by "[Load settings from file](#)" or by completing a new configuration "**Edit settings**".
3. Ensure the system is operational and all sensors are "Calibrated".
4. Click "**View totals**" and re-enter the total values recorded prior to the upgrade (if desired).
5. Click "[Start device](#)" and "Exit" from FloCom+

Recharging an HVFlo XCi

The HVFlo XCi can be charged from any DC source of 16-30 Volts (2 Amps).



NOTE: MACE recommends charging using the dedicated MACE Trickle Charger (850-323).

1. The charger available from MACE (Part No. 850-323) comes complete with a circular barrel connector that plugs directly into the XCi device.



NOTE: The barrel connector for the 16-30VDC charger input is centre positive

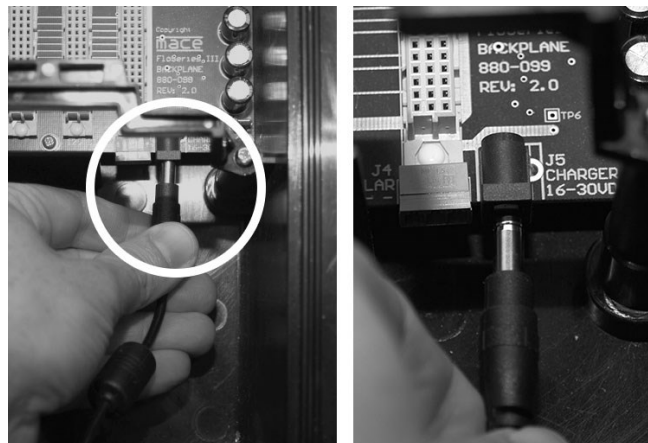

2. Alternatively, if a DC source other than a MACE charger is used, this is terminated using the three-pin connector adjacent to the barrel connector.



NOTE: MACE recommends the HVFlo XCi is left on charge for at least 8 hours (overnight).

Battery maintenance

The XCi device's internal battery, if kept fully charged should last many years. However, if the battery remains flat for an extended time, it may be damaged and should be replaced. Contact your vendor for a replacement battery.



NOTE: MACE recommends the main battery is replaced every 5-7 years regardless of *perceived* battery status to ensure system longevity

Removing the old battery

1. Disconnect the battery cable assembly from the backplane board.

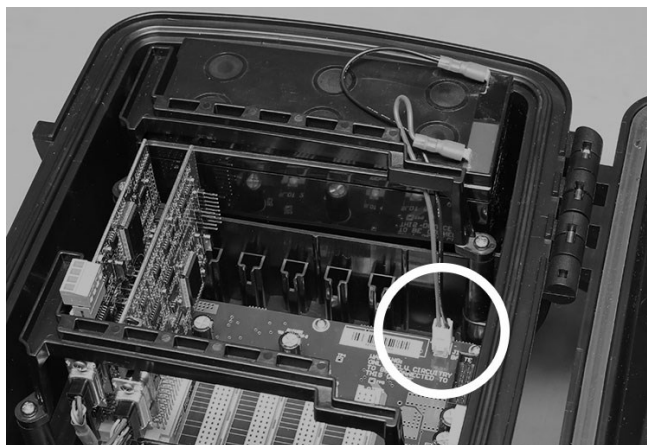

2. Use a #2 Phillips head screwdriver to remove the three screws which fasten the battery bracket to the main enclosure.

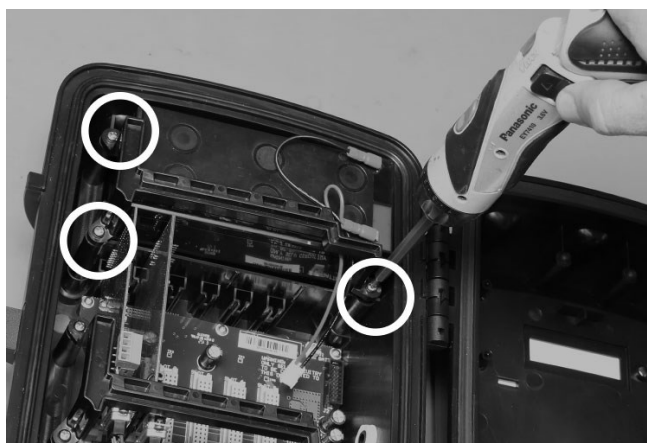

3. Carefully remove the battery from the main enclosure.

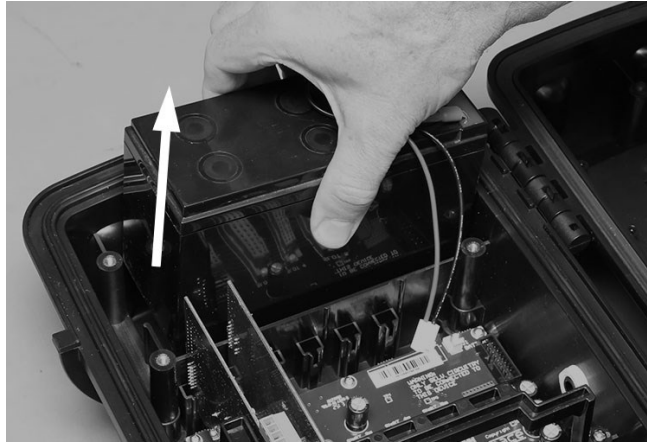

4. Disconnect the battery cable from the battery terminals.

Installing the new battery

1. Connect the battery cable to the new battery, with the red lead to the positive terminal of the battery and the black lead to the negative terminal.

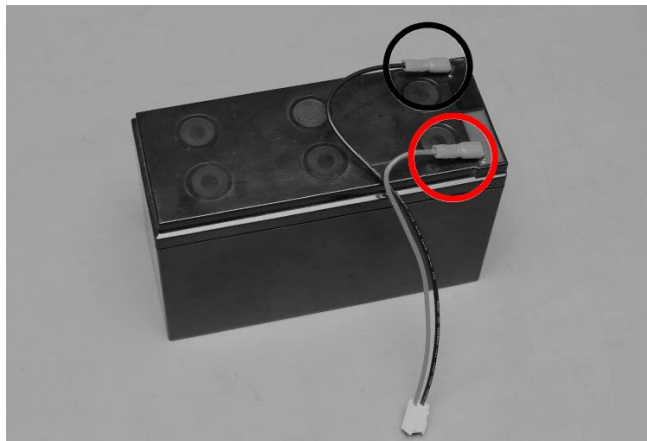

2. Place the battery in the main enclosure and hold it in place.
3. Secure the new battery in place using the battery bracket and three screws.
4. Ensure the battery cable is guided under the bracket as shown.

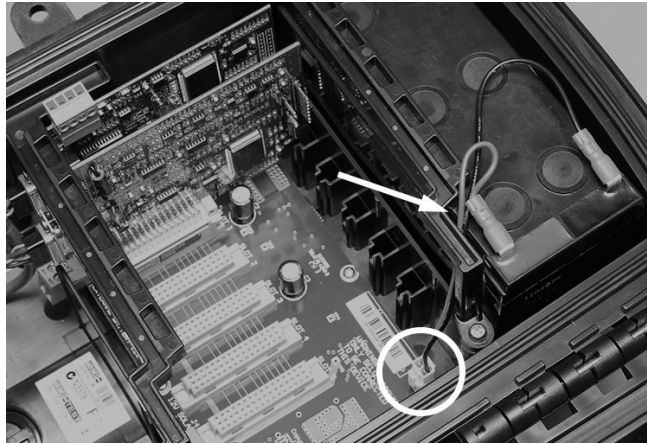

5. Tighten all three screws.
6. Reconnect the battery cable assembly to the backplane board.

Velocity sensor maintenance

To ensure trouble free data collection, sensors mounted in the flow should be kept free of built up debris, silt or grease. This is done by using a stiff bristle brush and carefully cleaning the sensor head and surrounding area. This process should be repeated as often as necessary in order to keep the sensors clean. Also check the sensor cable for physical damage.



WARNING: Do not use steel bristle brushes that may cause damage to either the MACE velocity or depth sensors.

Velocity sensor testing:

To perform this procedure you will need a MACE Doppler Sensor test kit (850-260) and a digital multimeter capable of reading capacitance (<math><2\text{nF}</math> range) and resistance (>20MW).

Check the capacitance and resistance values according to this chart:

Sensor type	Cable length (m)	Capacitance (TX)	Capacitance (RX)	Resistance (TX)	Resistance (RX)
Doppler 2" insertion sensor	10m	1.2nF to 1.8nF	1.2nF to 1.8nF	>20MW	>20MW
	20m	1.8nF to 2.5nF	1.8nF to 2.5nF	>20MW	>20MW
	30m	2.3nF to 3.1nF	2.3nF to 3.1nF	>20MW	>20MW
	50m	>8nF	3.1nF to 4.2nF	5.2 to 5.6KW	>20MW
Doppler velocity sensor and Doppler area/velocity sensor w/o replaceable ceramic	10m	1.2nF to 1.8nF	1.2nF to 1.8nF	>20MW	>20MW
	20m	1.8nF to 2.5nF	1.8nF to 2.5nF	>20MW	>20MW
	30m	2.3nF to 3.1nF	2.3nF to 3.1nF	>20MW	>20MW
	50m	>8nF	3.1nF to 4.2nF	5.2 to 5.6KW	>20MW
Doppler area/velocity sensor with replaceable ceramic	10m	>8nF	1.2nF to 1.8nF	5.2 to 5.6KW	>20MW
	20m	>8nF	1.8nF to 2.5nF	5.2 to 5.6KW	>20MW
	30m	>8nF	2.3nF to 3.1nF	5.2 to 5.6KW	>20MW
	50m	>8nF	3.1nF to 4.2nF	5.2 to 5.6KW	>20MW

How to store the XCi when not in use

Although the vast majority of installed HVFlo XCi devices are left "in the field" during periods of non-use, some users choose to remove them to "overwinter".

If removing the device, there are some simple steps to make sure everything will work upon the next installation:

Store the XCi

1. Always "**Stop**" the unit with FloCom+
2. **ALWAYS** leave the main battery connected.. The XCi draws very low current (μA) when "stopped", and the main battery will last at least 6 months.



NOTE: If the XCi is not going to be used for more than 6 months, the XCi device should be put on a 16-30VDC charger periodically to keep the battery charged.

Store the sensor

1. If removing the sensor, ensure that it is stored somewhere where the connector end of the sensor remains dry **AT ALL TIMES**.
2. If you have an area/velocity sensor, "**Disable**" the reference filter by firmly screwing the cap closed.



WARNING: If you intend to leave the sensor in the field without being connected to the XCi device, you **MUST** make the connector end of the sensor waterproof.

How to replace the depth module in an Area/Velocity sensor

Due to the presence of silt, large gravel and debris in channels, the depth sensor component of any area/velocity sensor can be physically damaged through impact of large debris. To reduce costs and downtime, MACE has developed a replaceable ceramic depth sensor, eliminating the need to replace the entire A/V sensor. It is simply a matter of unscrewing the old sensor and replacing with a new one. An “o-ring” seals the sensor electronics, and a locking ring holds the new sensor in position.



NOTE: For this procedure, you will need a MACE Replaceable ceramic installation tool (850-481), and a MACE Replacement ceramic kit (850-410).



WARNING: This procedure should **ONLY** be carried out by MACE trained and qualified staff in a clean and dry area.



WARNING: All sensor products must be clean and free of any potential biological hazards. MACE recommends washing with microbicidal fluid.

Remove the damaged ceramic depth sensor

1. Place the clean and dry sensor on a flat workbench.
2. Find the "**locating pins**" on the base of the ceramic installation tool and the matching "**apertures**" on the locking ring. Position the tool onto the locking ring.

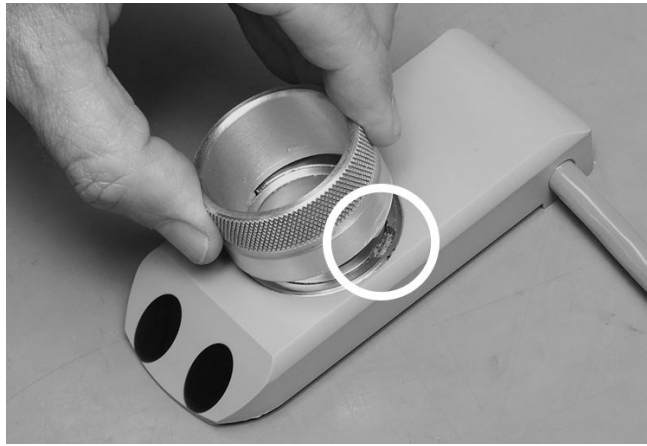

3. Unscrew the locking ring using the tool, and remove completely.

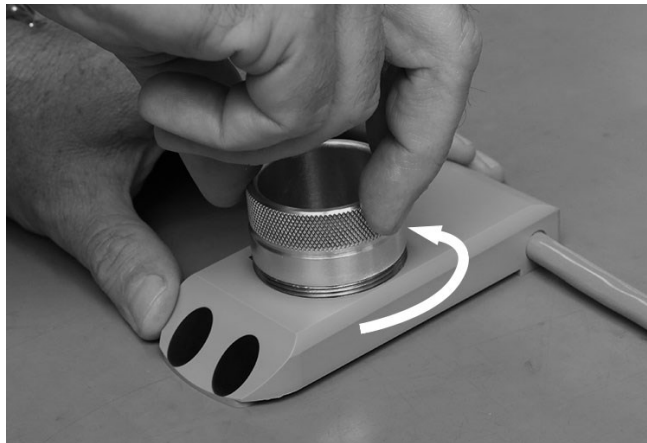

4. Remove the damaged ceramic depth sensor.





NOTE: Under some circumstances, the module may be slightly 'stuck'. In that case, you may need to use a small flat bladed screwdriver to gently lever it out of position.

5. Remove the o-ring using a fingernail.



WARNING: Be careful not to damage the sealing surface by using any tools.



WARNING: The inside of the area/velocity sensor **MUST** be cleaned with a clean rag and isopropyl alcohol. Let it dry thoroughly before installing the new ceramic depth module.



WARNING: The airline should be dried out thoroughly by running compressed air through it overnight.

Installing the new ceramic depth sensor

1. Squeeze a "pea-size" amount of o-ring grease onto your fingers, and work it into the o-ring supplied with in the replacement ceramic kit.



NOTE: MACE recommends Molykote 111 compound.

2. Carefully position the newly greased o-ring onto the sealing surface within the area/velocity sensor.



3. Find the "**locating pin**" on the base of the ceramic module and the matching "**aperture**" within the area/velocity sensor.

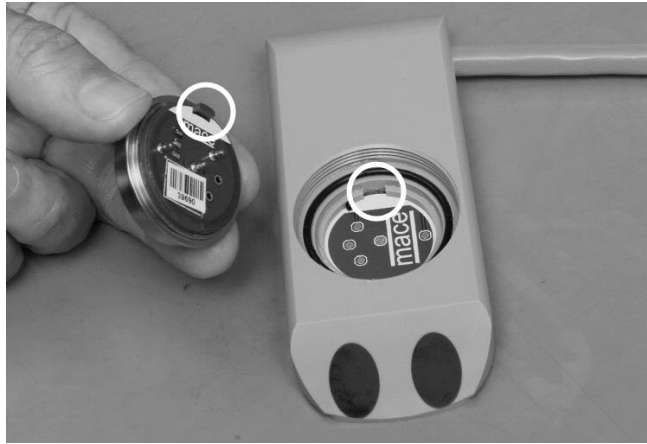

4. Place the ceramic module so that it sits flush with the o-ring.



5. Gently start to screw the "locking ring" in by hand. Only turn it one or two turns, just enough to get the thread 'started'.



WARNING: Ensure the locking ring has the two "apertures" face-up.



6. Position the ceramic installation tool into the locking ring using the locating pins/apertures.



WARNING: Hold the ceramic module in place with one finger, whilst turning the locking ring. Ensure that the ceramic module **DOES NOT MOVE** during this process. The locking ring should only be tightened **FINGER-TIGHT**. A slight compression of the o-ring should be felt. **DO NOT** use any tools to grip the installation tool.

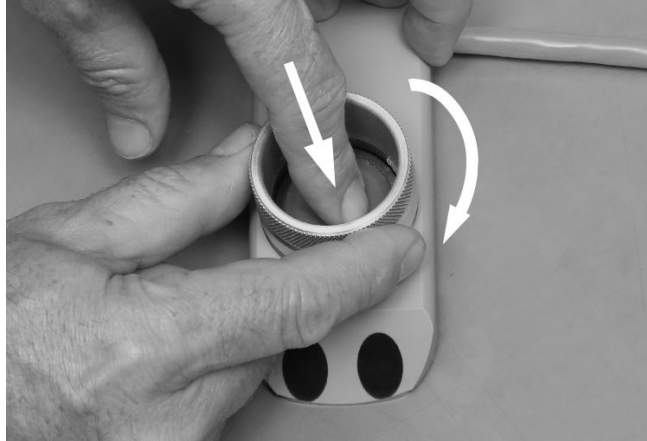

8. The sensor has now been serviced and can be [re-installed](#) and [calibrated](#).

Maintaining the HVFlo breather valve

The ceramic depth sensor used in a MACE Doppler ultrasonic area/velocity sensor measures the hydrostatic pressure of the stream depth. This sensor is vented to atmospheric pressure via a vent tube inside the sensor cable. This vent passes through the HVFlo XCi specific area/velocity sensor connector and into the HVFlo XCi enclosure. Since the HVFlo XCi has a waterproof environmental rating (IP68), the enclosure is made to "breathe" via a hydrophobic membrane "breather valve" (made by Gore®).



WARNING: Although the breather valve is both hydro- and oleo-phobic, in the case where the HVFlo XCi has been submerged, the breather valve MUST be replaced before being re-deployed.

The following procedure should be followed in order to replace the breather valve:

1. Locate the breather valve on the inside right of the enclosure.



2. Ensure you have a MACE Gore Air-vent for HVFlo kit (850-406)



3. Remove the vent nut, using a 17mm spanner, and remove the old breather completely.

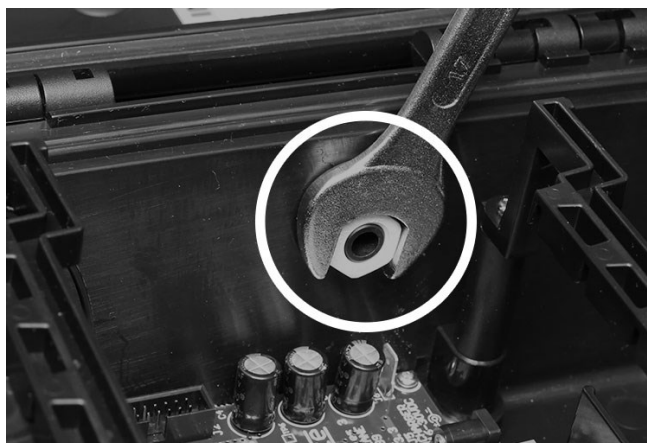

4. Push the new breather into place (ensure that the o-ring seats squarely) and tighten the nut. There is no need to overtighten. Only tighten enough so that the o-ring is compressed and the nut will not "fall" off.

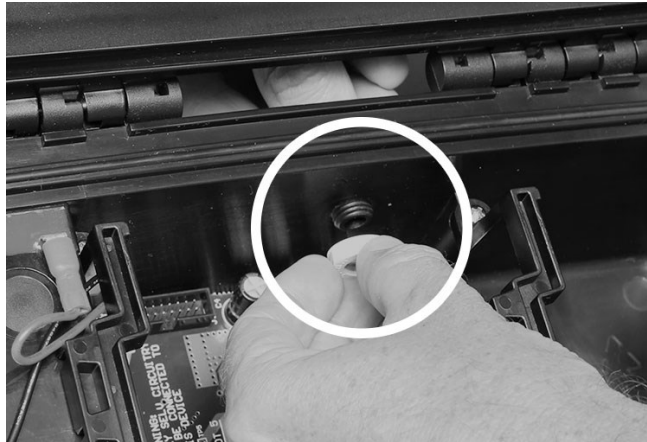

WARNING: Be careful NOT to cross-thread the nut as this WILL lead to the HVFlo not maintaining its waterproof rating.

MACE USB cable driver installation

1. Under certain circumstances, "**Windows**[®]" may not find the driver for the MACE USB cable (850-363) when it is first plugged in.
2. The following procedure (correct in Windows 8.1) will ensure that the MACE driver is installed:
3. Navigate to the "**Device manager**" in your version of Windows.
4. You will see a tree item called "**Other devices**" where the uninstalled (marked with an ! - mark) USB Serial port is residing.

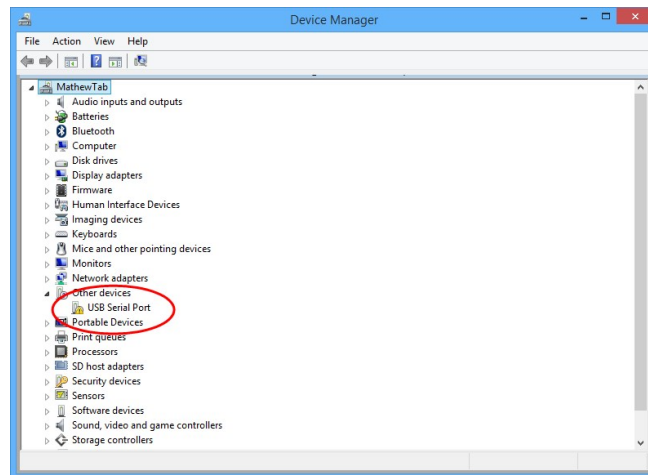

5. Double-click on the "**USB Serial port**" icon and open its "**Properties**" dialogue box. The device status box confirms there are no installed drivers

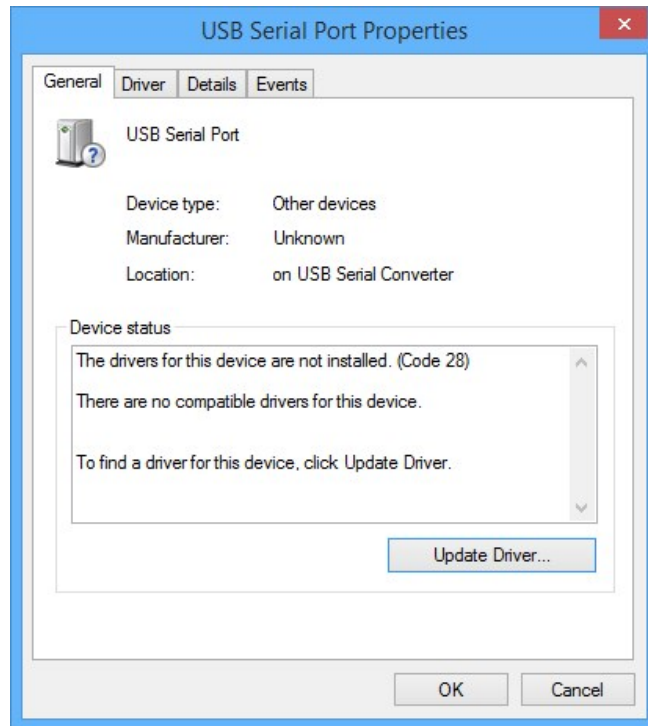

6. Navigate to the MACE Website and **"Run"** the driver setup file

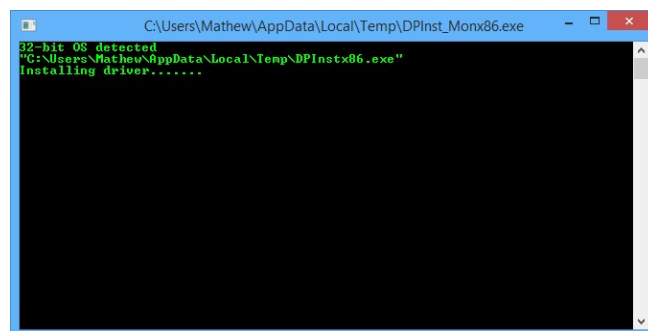
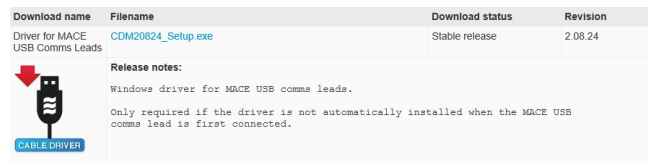

7. Upon completion the USB Serial port properties will show that the device is now installed.

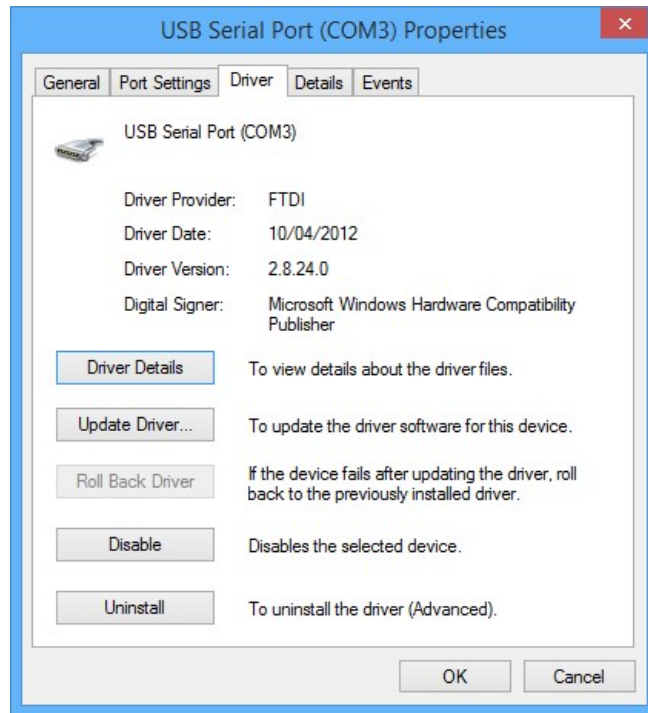

How to re-initialise an XCi

Tools required

- PC running latest version of FloCom+
- MACE USB Communication Cable (Part No. 850-363)
- Phillips screwdriver (#2)

1. "**Connect**" to device with FloCom+ and "**Download data**". "**Stop**" device, then "**Save settings to file**". "**Disconnect**" and shut FloCom+.
2. Disconnect the battery by un-clipping the white connector at "**J1 Battery**".



3. Unscrew the bracket that holds the cards in, using a Phillips #2 screwdriver.

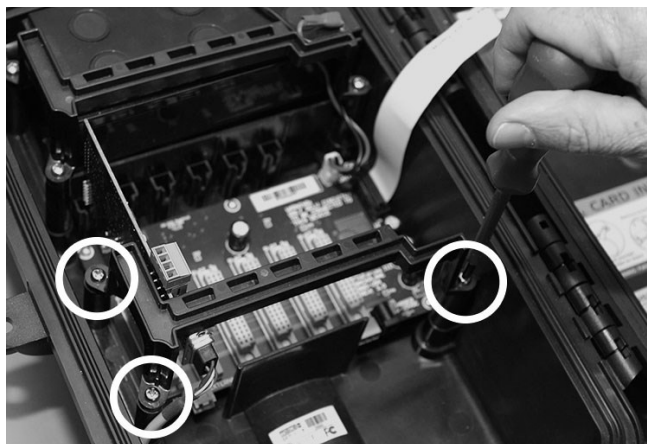



WARNING: Make sure you understand AND follow the "[Installing FloSeries3 Cards](#)" procedure BEFORE the next steps:

4. Remove all cards EXCEPT the Controller card (Slot#0) from the FloSeries3 backplane.



WARNING: You MUST note the Slot# that each individual card was removed from, as they MUST be replaced into the same slots.

5. Wait for at least 1 minute, **This allows the microprocessor on each card to reset.**
6. Re-connect the battery by plugging the white connector back onto "**J1 Battery**". It will only connect one way.
7. Replace each of the cards back into the **SAME** Slot#'s from which they were removed. This should be done one card at a time with at least a 30 second delay between each card.
8. When all cards have been replaced, re-install the bracket that holds in the cards.



WARNING: Take care not to drop screws or touch any of the cards with the screwdriver as damage may occur.

9. "Connect" to device with FloCom+ and "**Set device date/time**" from the "**System**" menu if required.
10. Click "**System**", then "**Card Check**" and ensure that all installed cards are visible. If not, follow the procedure outlined in "[Installing FloSeries3 Cards](#)".
11. Re-configure device if required



NOTE: Depending on the state of the device prior to re-initialisation this may/may not be necessary. If required, "Load setting" from the file you saved in Step 1 above.

MACE product repair procedure

In the unlikely event that your HVFlo XCi device requires servicing at a MACE facility the following procedure should be followed to ensure efficient service.



WARNING: Due to the potentially hazardous environments in which MACE equipment operates, cleaning PRIOR to sending to a MACE service centre is mandatory so we can ensure the safety of our service technicians. All products used in wastewater applications must be certified clean and free of any potential biological hazards.

1. Note the Serial Number/s and the instrument type of the products that you wish to ship for service.
2. In a manner appropriate to each device, decontaminate all exposed surfaces of Doppler sensors and instrument housings. Seventy (70)% Isopropyl alcohol or a fresh solution of 1:25 (v/v) household bleach:tapwater is suitable for most disinfection. Instruments used with wastewater may be disinfected with a commercially available cleaner such as Lysol® or Pine-o-Cleen® if more convenient.
3. Complete the "**Cleaning Certificate**" ([download here](#)). Make a copy of the certificate and tape it to the outside of the box. The original certificate should be packed with the goods. If cleaning is not performed and/or a "**Cleaning Certificate**" is not returned with the product, MACE reserves the right to withhold service until appropriate cleaning and certification have been completed. We will contact the sender with regards to the disposition of the products.
4. Visit the MACE website and request a "**Returned Goods Number (RG#)**" by filling in the appropriate details in the form.
5. MACE will contact you with an RG#, This MUST be written on the outside of the shipping box and on any documentation being sent.



WARNING: If products are returned to a MACE facility without an RG#, they will not be serviced until such time as the RG# Request form has been completed on the website.

6. Pack the products to be returned in an appropriate manner. MACE instruments are fragile and should be treated as such in any shipping context.



NOTE: Although the lead-acid battery used in XCi devices is certified for air travel, MACE recommends removal of the main battery for return to MACE.

MACE Limited Warranty

1. MACE warrants that any software supplied will perform substantially in accordance with the description and/or accompanying materials for a period of 90 days from date of receipt. MACE warrants that any such software is, as far as it is possible to determine, free from errors, and that should Buyer report any software errors, MACE reserves the right to incorporate the fixes in the next scheduled release of that software product. MACE reserves the right to charge a fee for providing a software updating service.
2. MACE warrants that AgriFlo, FloPro, HVFlo and HydroMace electronics modules supplied shall be rendered free from all defects in materials and workmanship under normal use and service for a period of two years from date of shipment to the end user or three years from the date of manufacture, whichever comes first.
3. MACE warrants that Doppler ultrasonic sensors supplied shall be rendered free from all defects in materials and workmanship under normal use and service for a period of one year from date of shipment to the end user or two years from the date of manufacture, whichever comes first.
4. MACE warrants that all other MACE products supplied shall be rendered free from all defects in materials and workmanship under normal use and service for a period of one year from date of shipment to the end user or two years from the date of manufacture, whichever comes first.
5. Goods that are returned to Buyer following service by an authorised, quality certified, MACE service centre carry a 3-month warranty.
6. Goods that have been tampered with, adjusted, dismantled, or otherwise interfered with will be denied warranty.
7. In no event shall MACE, or its distributor, be liable for any damages whatsoever (including, without limitation, damages for loss of business profits, business interruption, loss of business information, or other pecuniary loss) arising out of the use of, or inability to use any MACE product, even if MACE has been advised of the possibility of damages.
8. Should any Product become defective during the warranty period, and provided that the customer returns the defective Product to MACE for inspection and testing, MACE will, in its sole discretion and at no cost to the customer, repair or replace the defective Product in question.
9. No warranty is included against any expense for removal, re-installation or other consequential damages of any nature arising from any defect.
10. The warranties set out above are the only warranties made by MACE and are expressly in lieu of all other warranties, expressed or implied including the warranties of merchant ability and fitness for a particular purpose.

11. During the warranty period, MACE will pay surface transportation charges both ways (between MACE and the customer) within Australia if the product proves to be defective within 30 days from the date of original shipment to the end user. Throughout the remainder of the warranty period, the customer will pay transportation charges to return the defective product to MACE, and MACE will pay for the surface transportation charges to return the repaired product to the customer. MACE will not pay air freight or packing and crating charges at any time during the warranty period.
12. This warranty does not apply if the Product has been used in a manner contrary to the Products manual or other instructions or has been used in detrimental environmental or other conditions or has been used in a manner likely to cause excessive wear and tear or has otherwise been improperly used or altered in any way.
13. Expendable items such as pump tubing or silica gel satchels are not covered by this warranty.
14. Third party items such as solar panels or trickle chargers are not covered by this warranty but are covered by their manufacturers warranty.
15. All requests for warranty service must be received within the warranty period.
16. This warranty is to the benefit of the original purchaser only and is not transferable on the re-sale of the Product without the expressed written approval of MACE.
17. Subject to any non-excludable contrary provisions of the Australian Trade Practices Act 1974 and corresponding New South Wales State legislation, MACE excludes all terms, conditions, warranties, undertakings, inducements or representations whether express, implied, statutory or otherwise relating in any way to the Product or its use.
18. Subject to any non-excludable contrary provisions of the Australian Trade Practices Act 1974 and corresponding New South Wales State legislation, MACE has no liability to the customer or third party in respect of any loss, consequential or otherwise, damage, injury, claim, demand, cost or expense however caused which may be suffered or which may arise in respect of the supply or use of the Product or in respect of any negligent act or omission of MACE of its servants or agents, or otherwise in connection with the supply or use of the Product or its fitness for a particular purpose. In no event shall the total liability of MACE (howsoever arising) exceed the amount paid by the customer for the Product covered by this warranty.
19. This statement represents the total warranty for MACE products and no person has the authority to alter it.